



Detailní doplňková sada
Detail accessory set

3057

T-72A-1

1/35

Exterior set for Tamiya kit

Navštivte naše stránky / Visit our official website

www.cmkkits.com

Polyurethane parts PUR

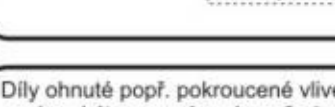
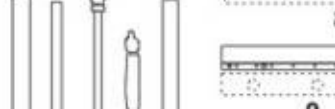
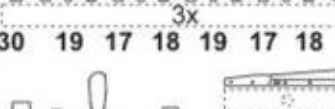
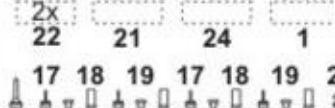
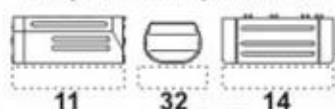
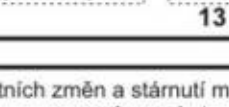
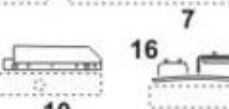
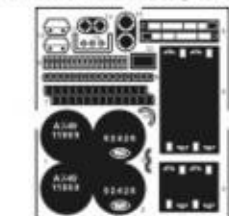

Photo-etched parts PP



Díly ohnuté popř. pokroucené vlivem teplotních změn a stárnutí materiálu, mohou být narovnány do požadovaného tvaru pomocí proudu teplé vody nebo vzduchu (fén na vlasy).

Parts slightly distorted and bended owing to temperature changes or due to material ageing can be straightened to requested shape by hot water or hot air jet. (hair dryer)

This process can be repeated till result is entirely satisfactory.

K lepení použít kyanoakrylátové lepidlo!

For best gluing result use cyanoacrylate glue!

Kontaktní plochy doporučujeme před lepením odmastit.

Degreasing of contact areas is recommended before gluing.

NEW ITEMS SETS 1:35

- 3058 T-34 - conversion set (Lybian and CSSR version)
- 3055 SdKfz.138 Ausf.M Marder III. - interior set
- 3054 Stug.III - exterior set (field and fabric version)
- 3052 Stug.III - driver set
- 3051 T-55C - conversion set (training and haulage version)
- 3049 Praga Lt.38/Pz.38(t) - engine set
- 3046 T-55A - engine set
- 3045 T-55AM2"Kladivo"- conversion set

BARVY / COLORS

HUMBROL

Veškeré zbarvení PUR dílů se řídí zvolenou kamuflážní barvou, pouze díly PUR 6,7,8,9,10 mohou být černé a díl PUR 24 je buď zelený nebo v barvě celtového plátna.

All PUR parts is in camouflage color, only parts PUR 6,7,8,9,10 can be black and part PUR24 either green or in color of duck.

1 Sestavení snorochlu / Snorkel assembly

Pouze pokud nepoužijete snoroch sestavený
Only if you don't use assembled snorkel

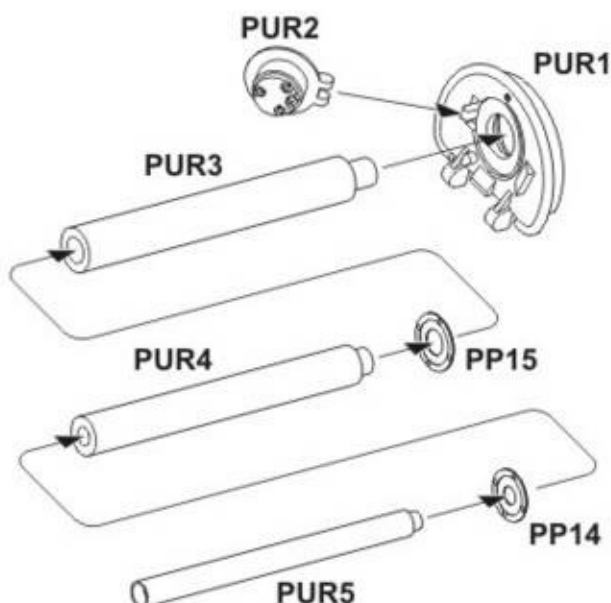

Nepoužijte díly / Don't use parts A2,A3,A26,A27,A30,A31,B5,B30,B31,B32,B33,B36,B44,B45,B64,B65,B74,B77,B78,B84

2 Montáž blatníků / Dash-board mounting

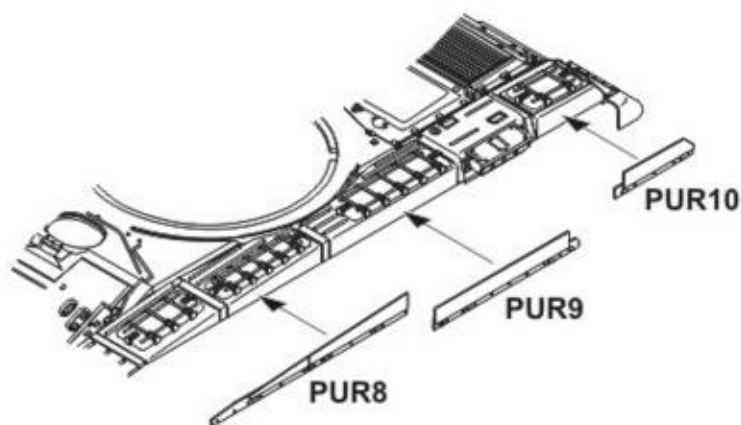
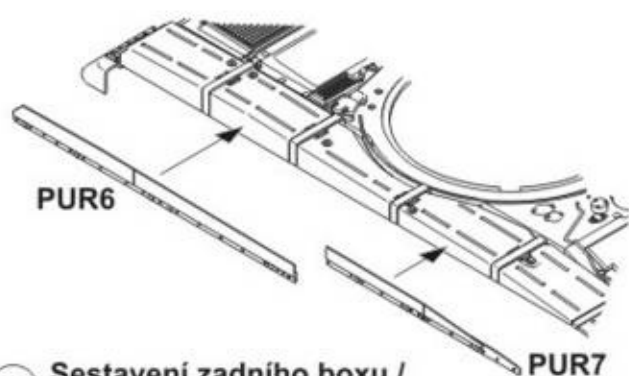

3 Sestavení zadního boxu / Back tool box assembly

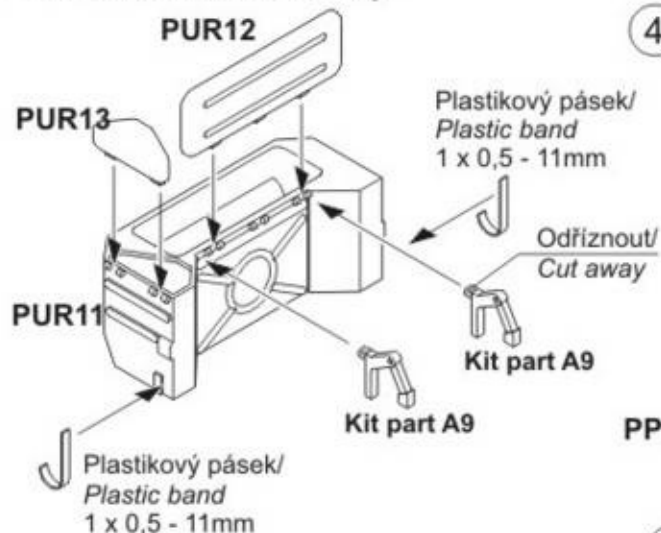

4 Sestavení pravého boxu / Right tool box assembly

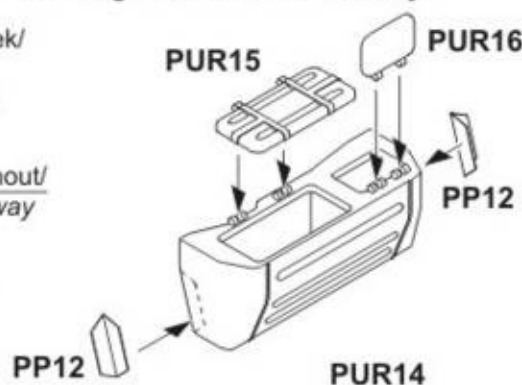

5 Sestavení kouřových výmetnice / Smoke dischargers assembly

Vyrobte 12 kusů
Make 12 items



6 Sestavení nábojových schránek / Amunition box assembly

Nahrazuje díly B77 a B78! Replace kit parts B77 and B78

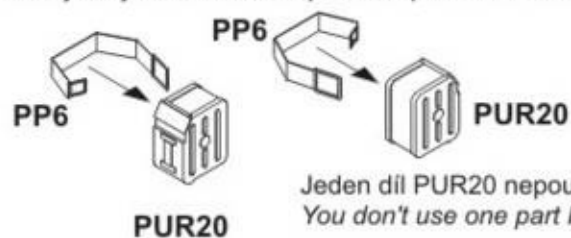

Jeden díl PUR20 nepoužijete
You don't use one part PUR20

7 Sestavení krytu velitele / Comander's hatch assembly

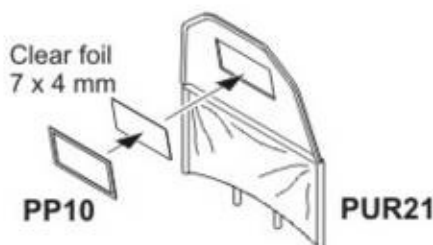

8 Dokončení boxů /
Box completion

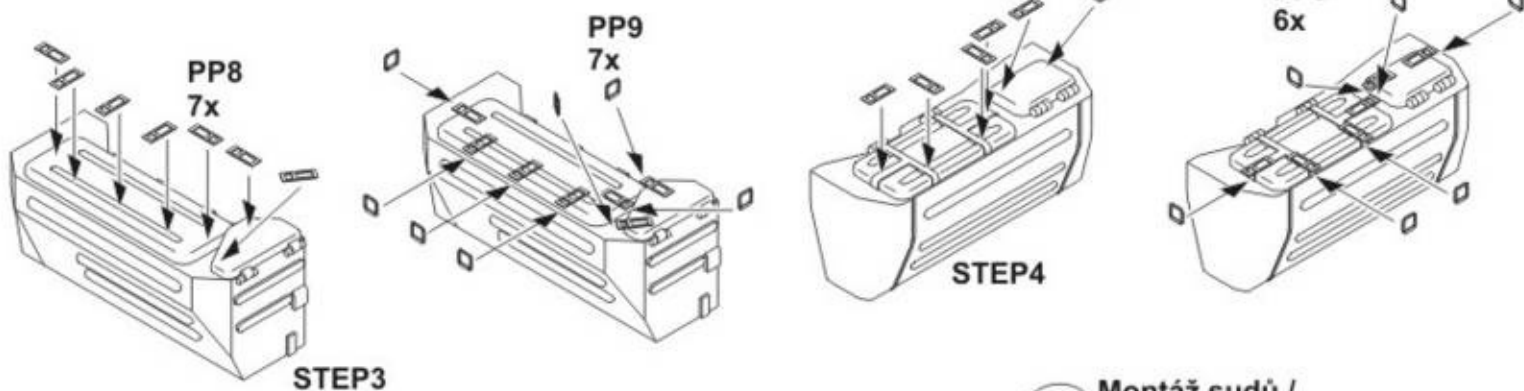

9 Sestavení palivových sudů /
Fuel drums assembly

Jeden díl PUR23 nepoužijete
You don't use one part PUR23

Odříznout/
Cut away

Kit part A8
Upravte 4 kusy/
Adapt 4 items

Vyrobte 2 kusy
Make 2 items

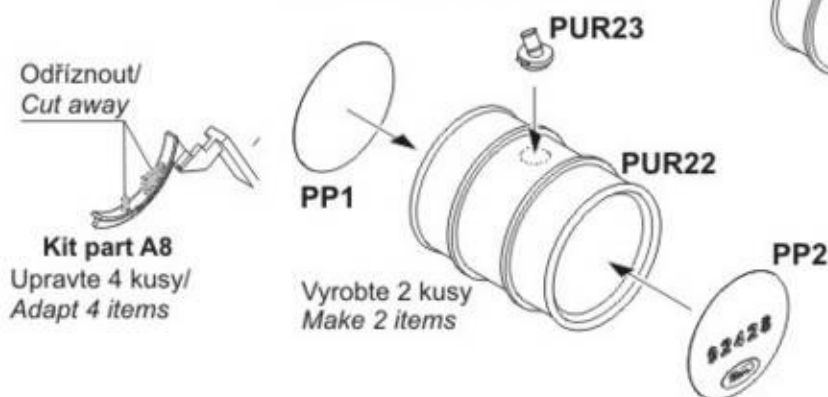

10 Montáž sudů /
Fuel drums mounting

STEP 9

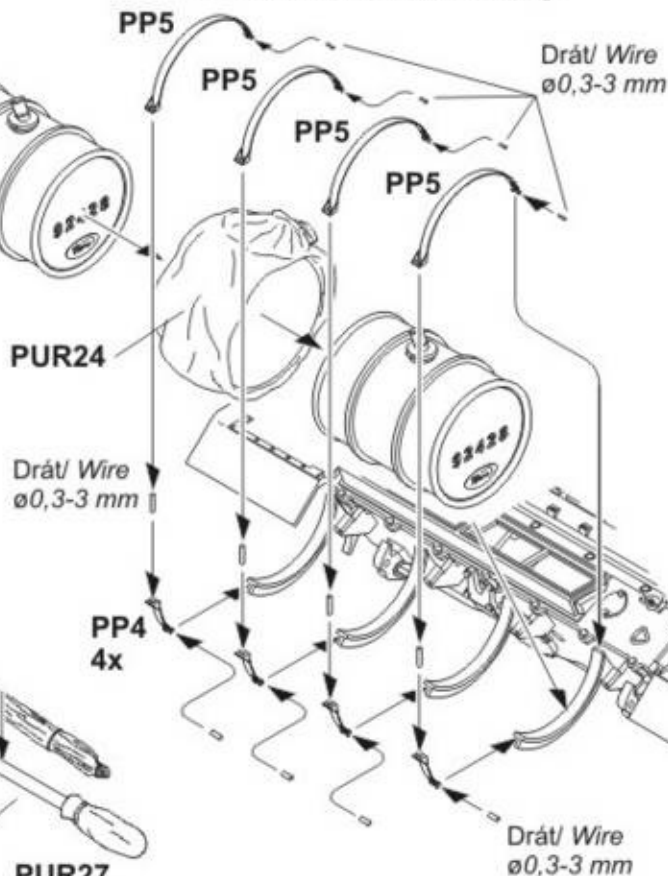

Pouze pokud nepoužijete krok 1
Only if you don't use STEP 1

PUR29

11 Vybavení levé části věže /
Left deal turret equipment

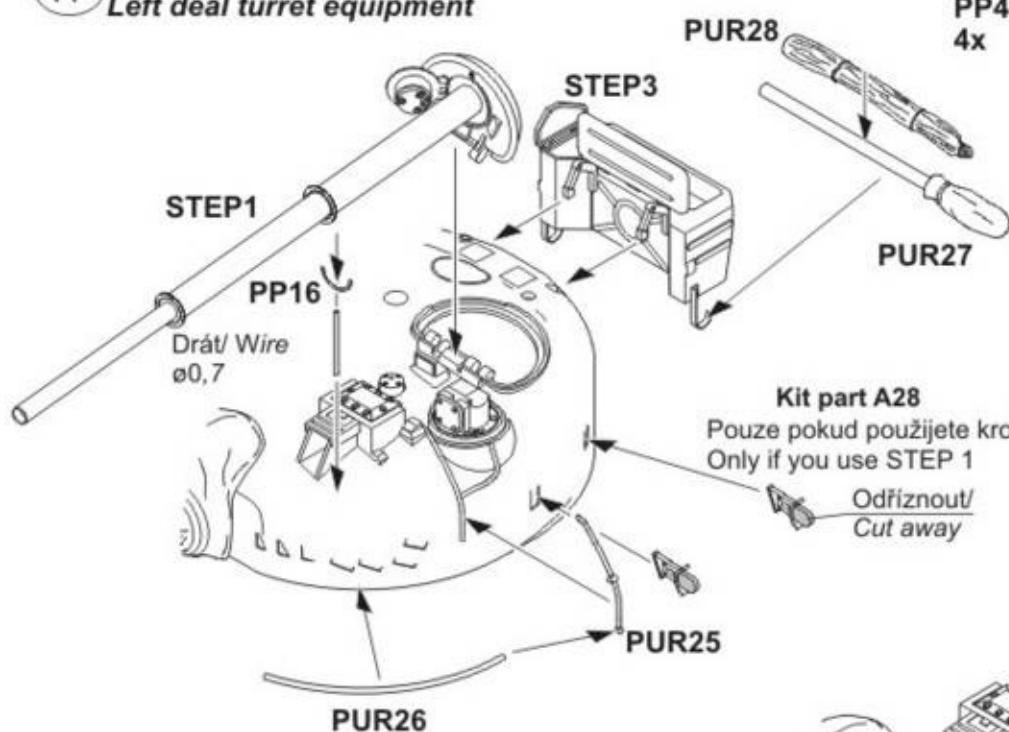

12 Vybavení pravé části věže /
Right deal turret equipment

Dva díly PUR30 nepoužijete
You don't use two parts PUR30

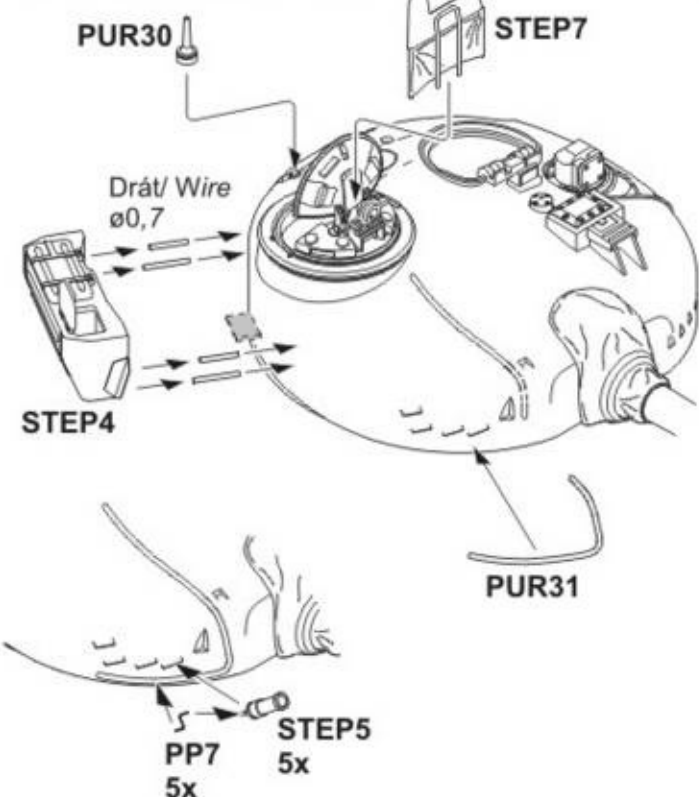

13 Montáž krytu řidiče /
Driver's hatch mounting

