

G.I.W.H.[®]

1/48
SCALE
L4825



雷电二式近距离支援攻击机
A-10A THUNDERBOLT II
CLOSE AIR SUPPORT ATTACK AIRCRAFT





A-10A THUNDERBOLT II 雷电二式 近距离支援攻击机



零件表 PARTS LIST

1/48 48225 SCALE AIRCRAFT

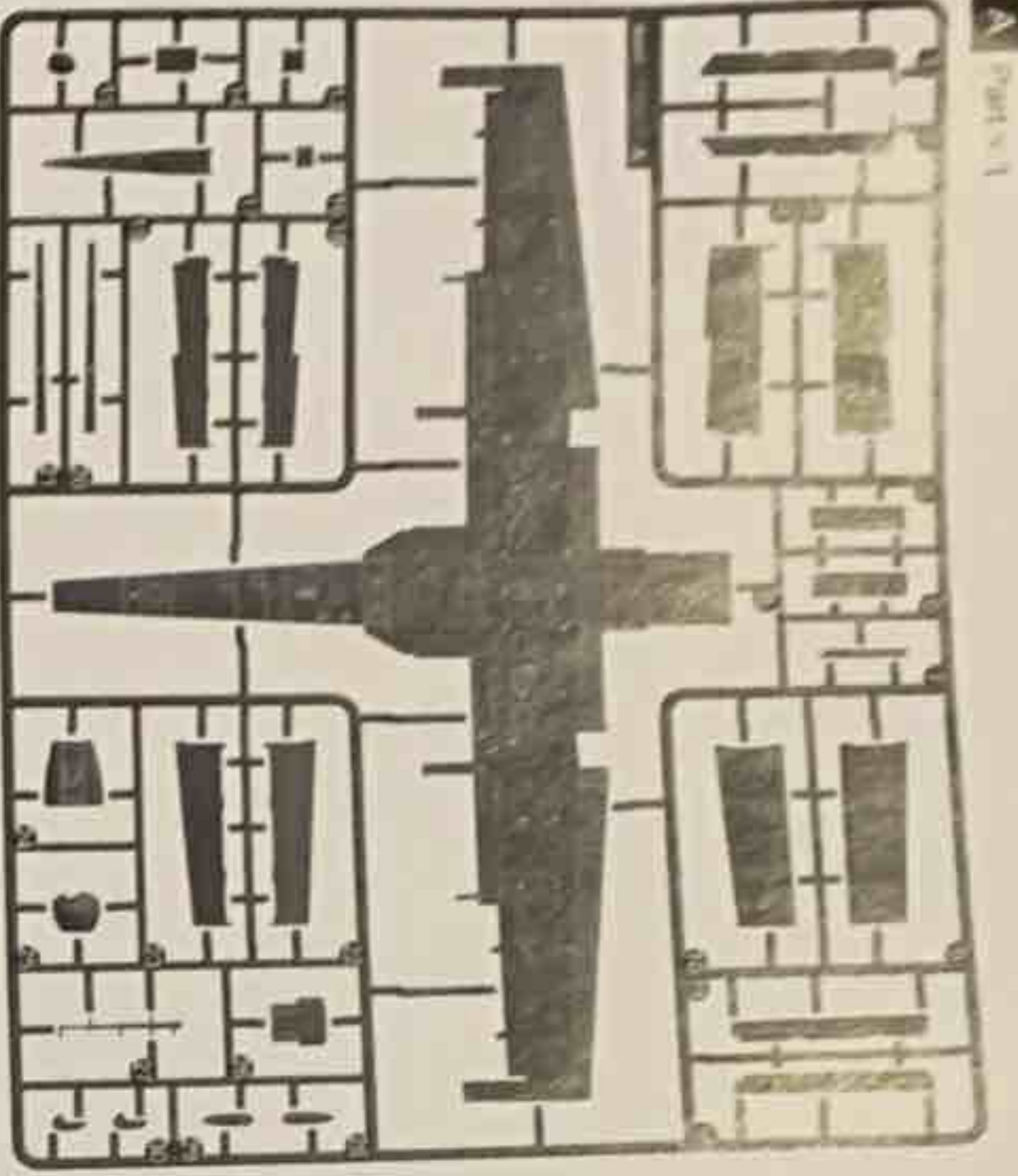

A Part X1

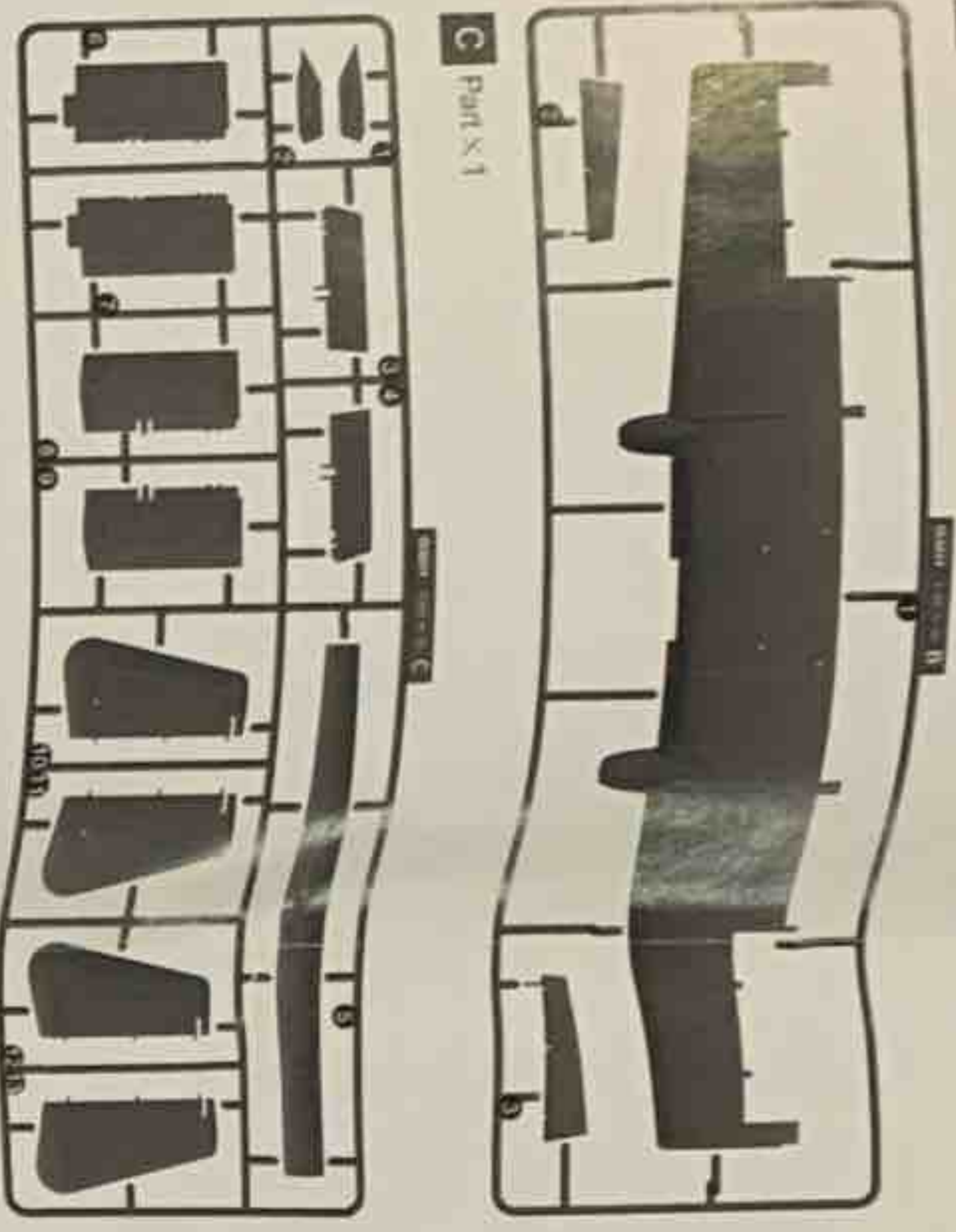

B Part X1

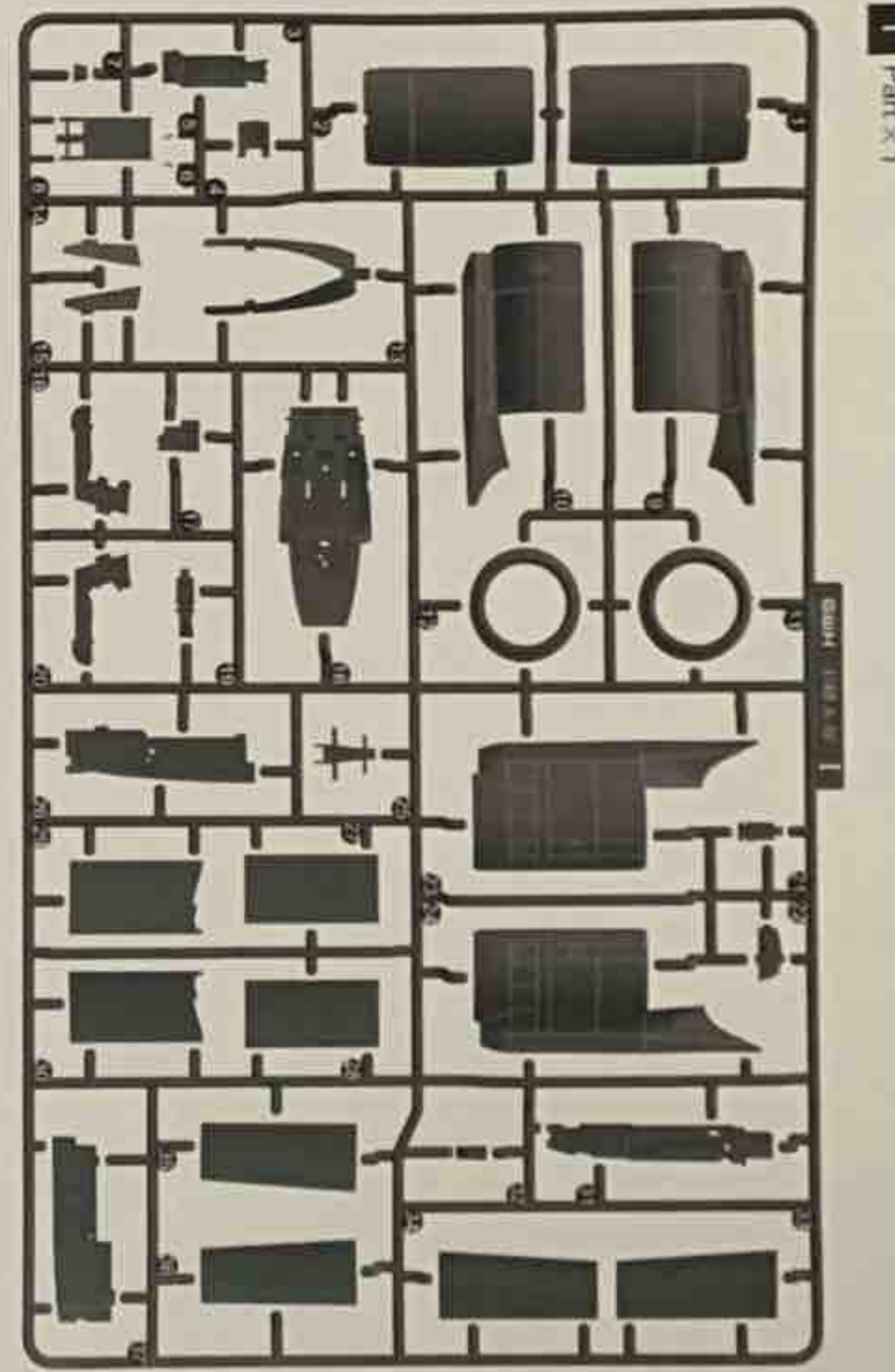

C Part X1



D Part X1

D Part X1

P Part X1

J Part X1

M Part X2

N Part X1

K Part X1

L Part X1

MK82 Part X2

LAU-131 Part X2

BRU-42 Part X2

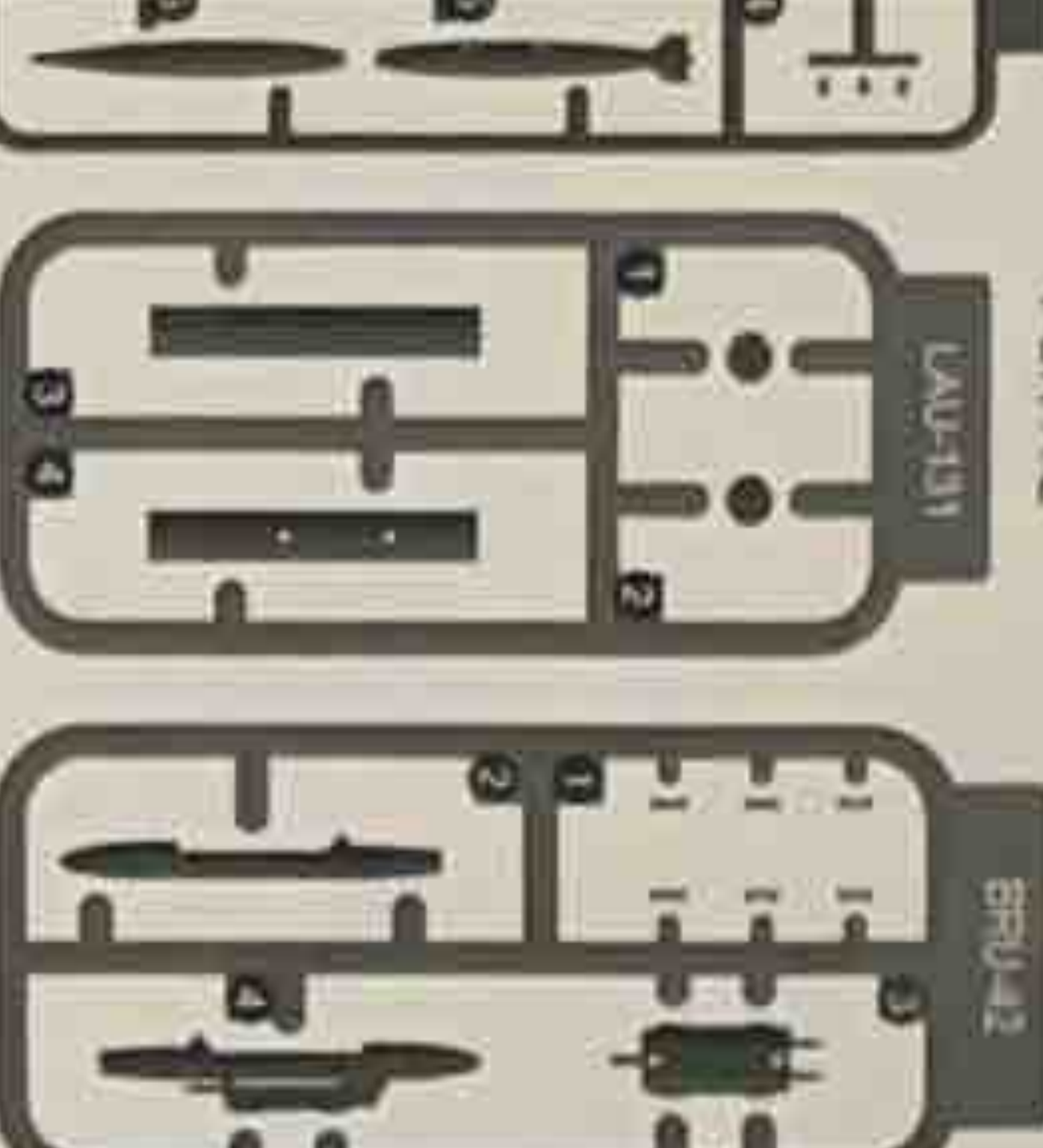
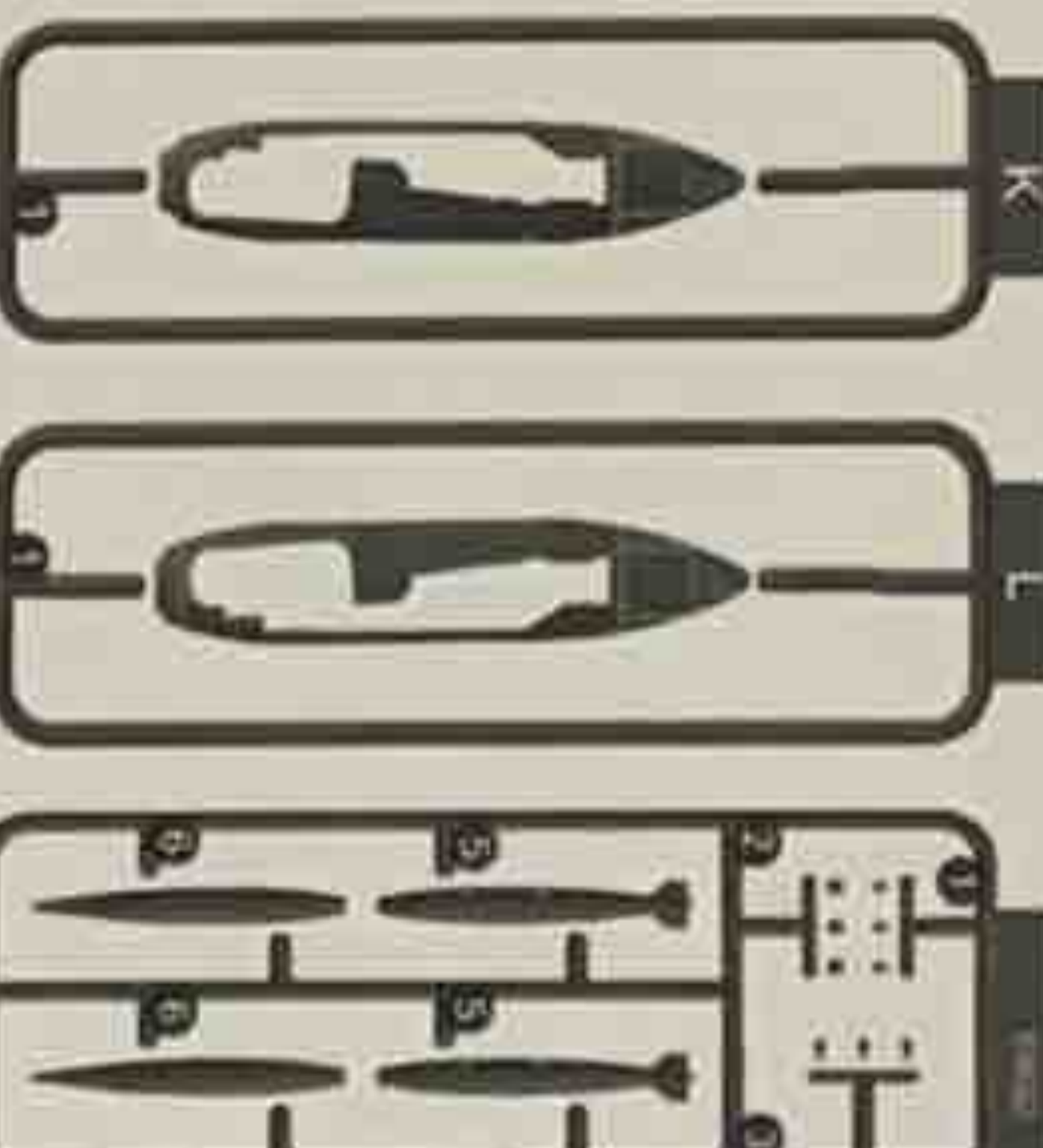
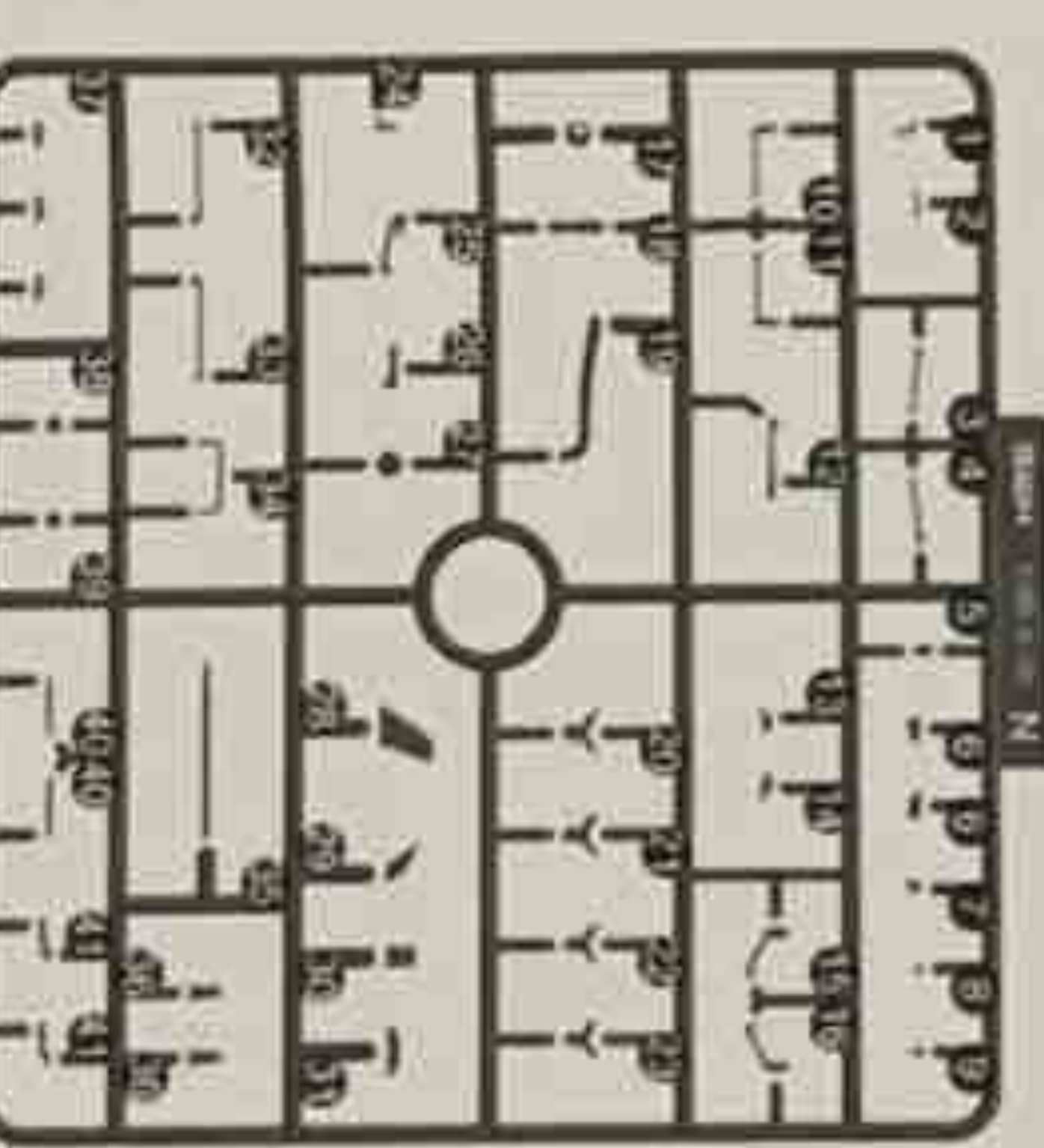
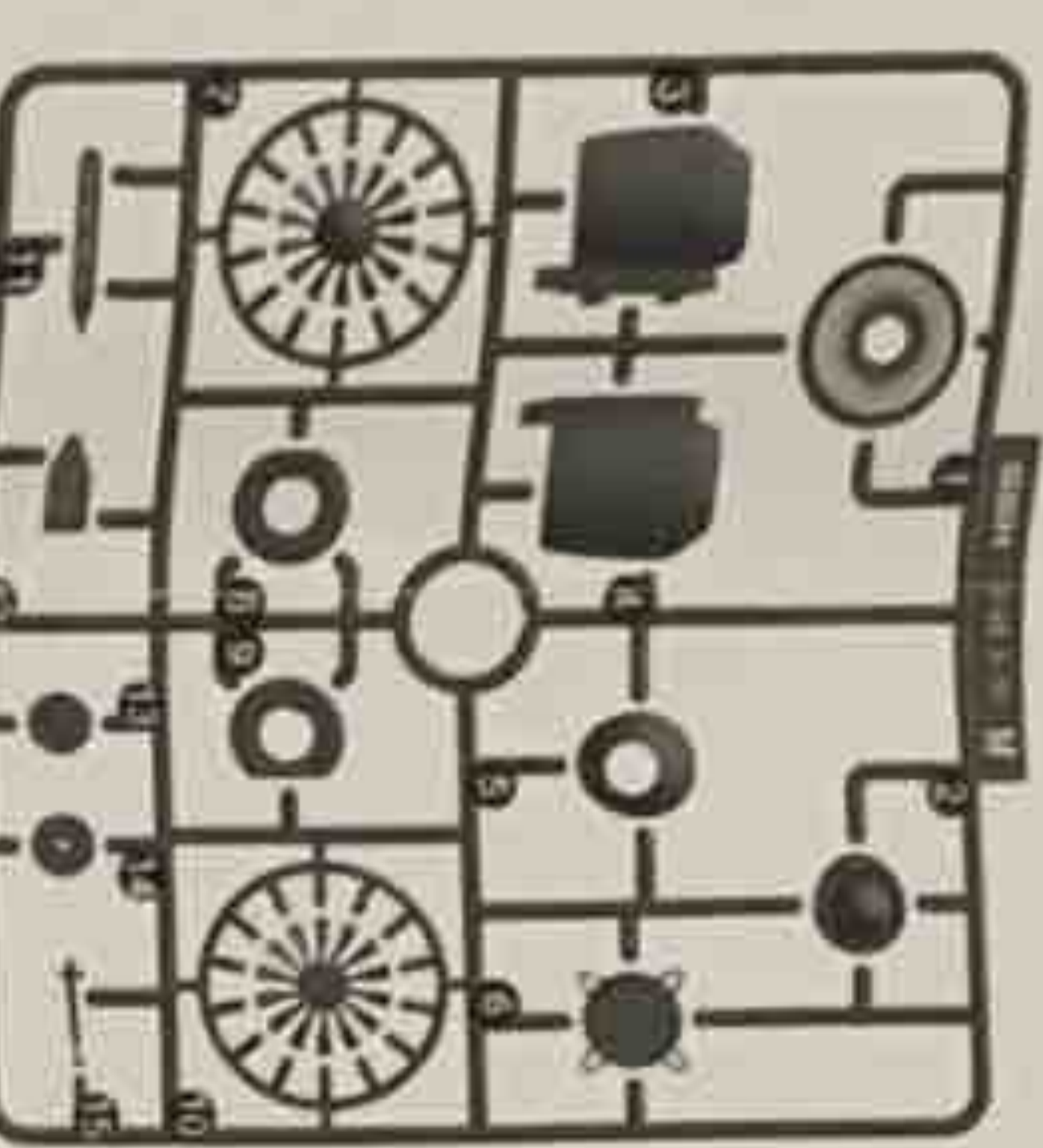
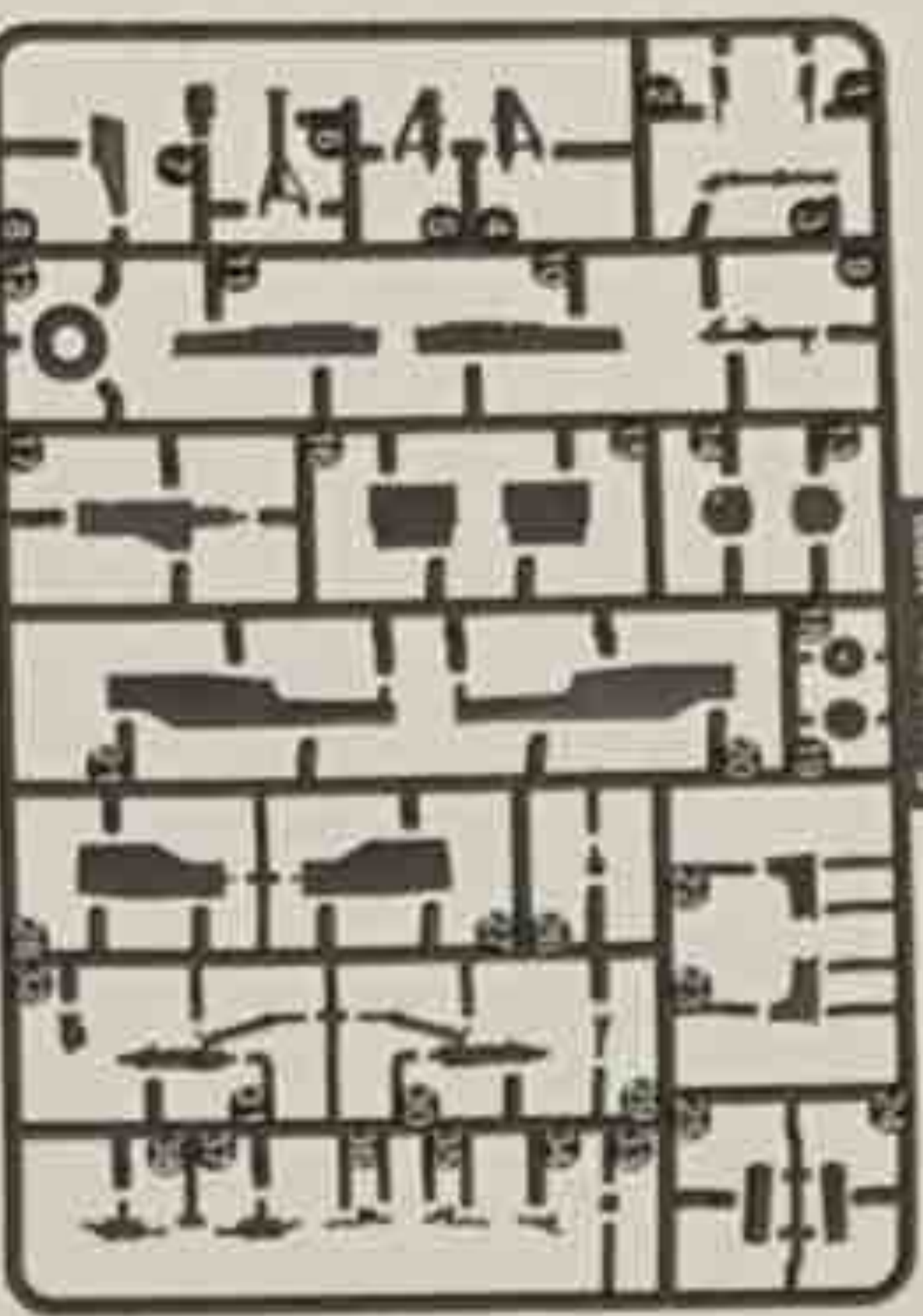
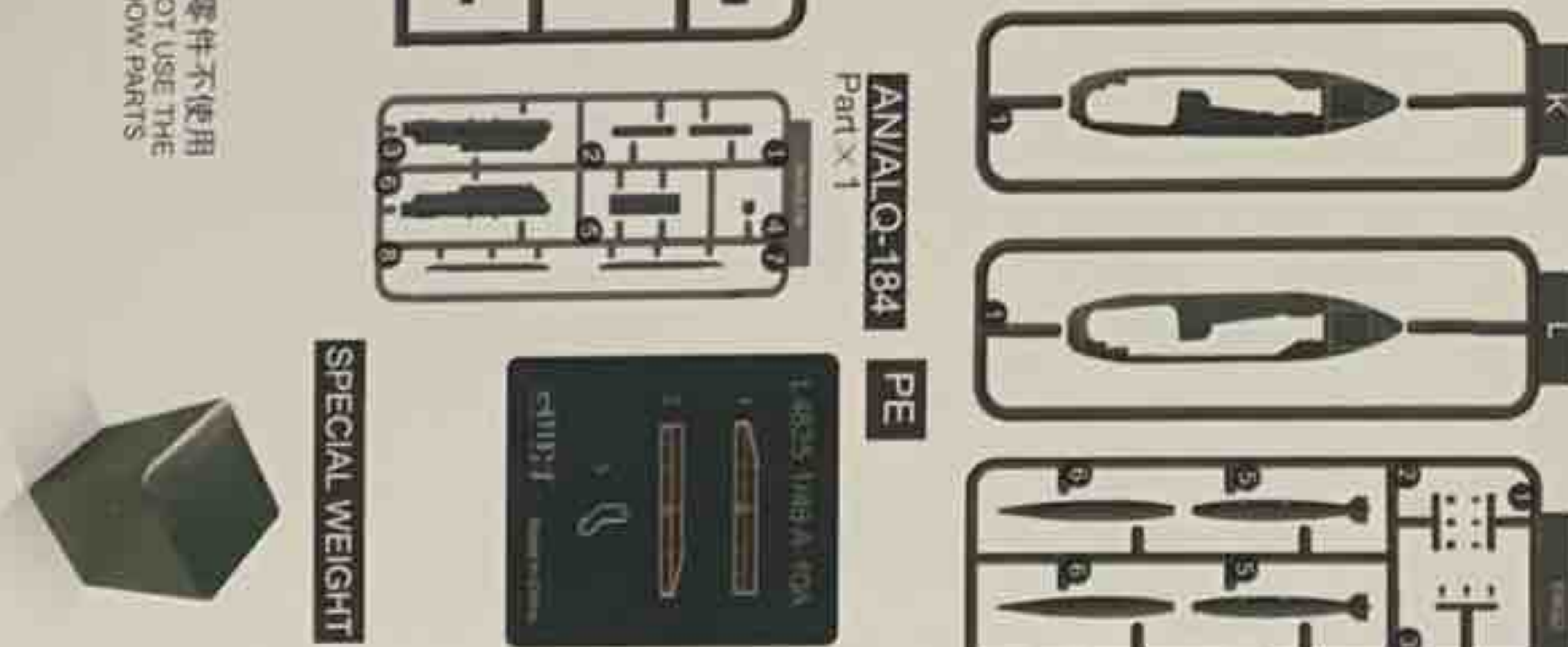
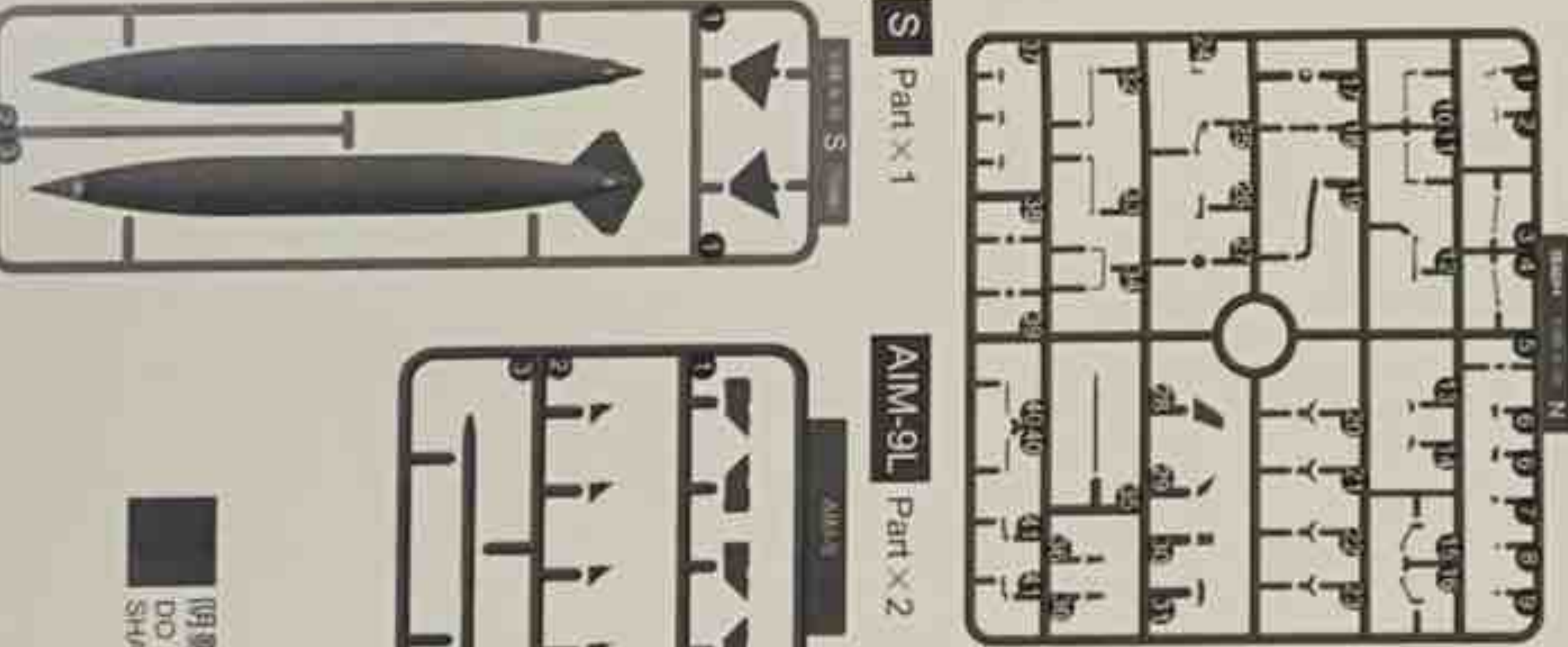
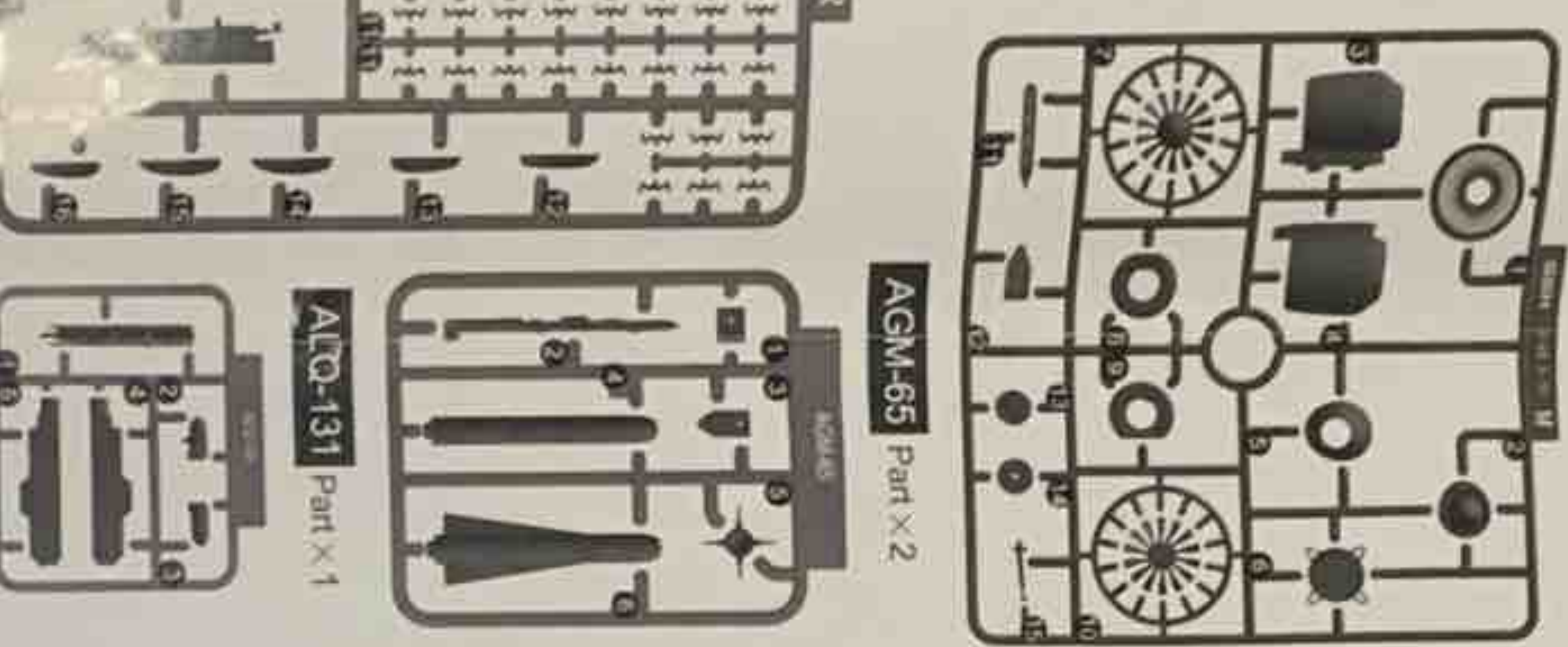
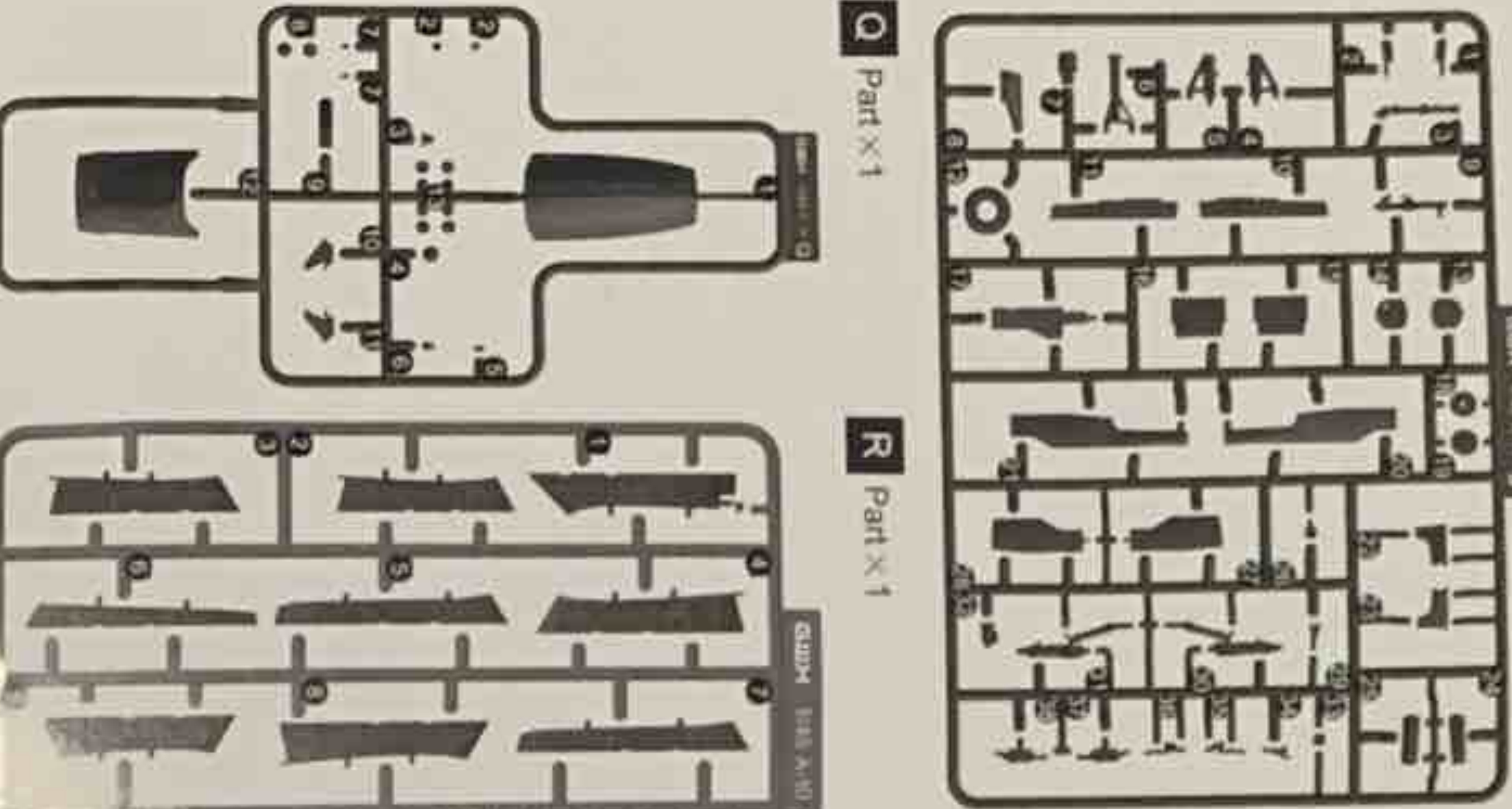
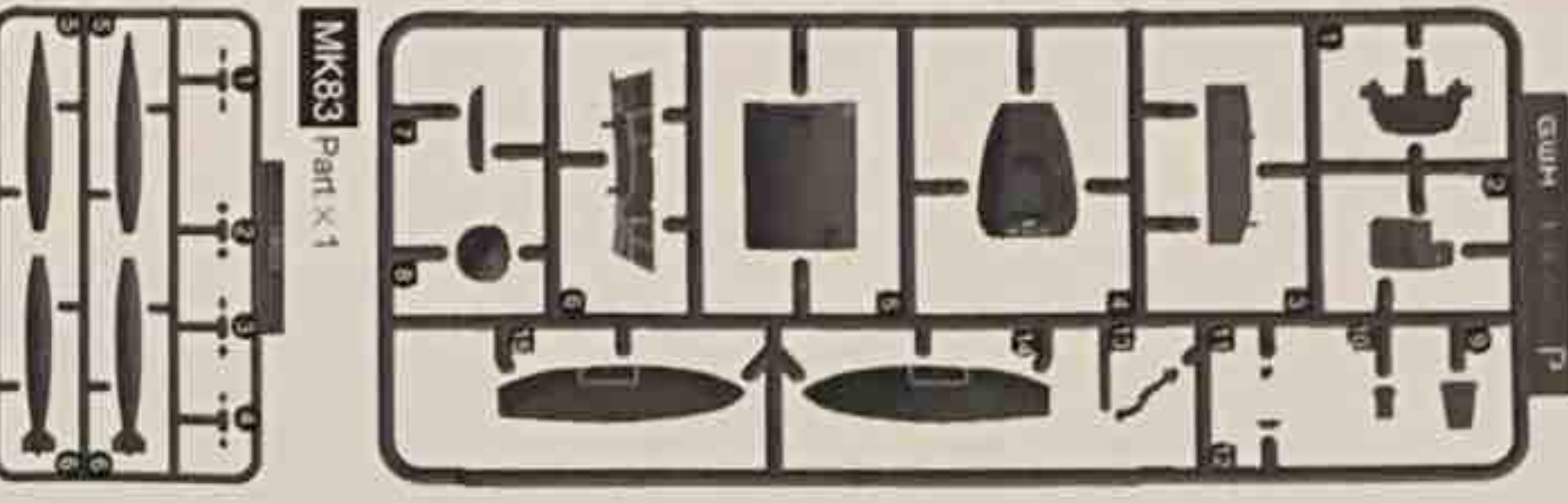
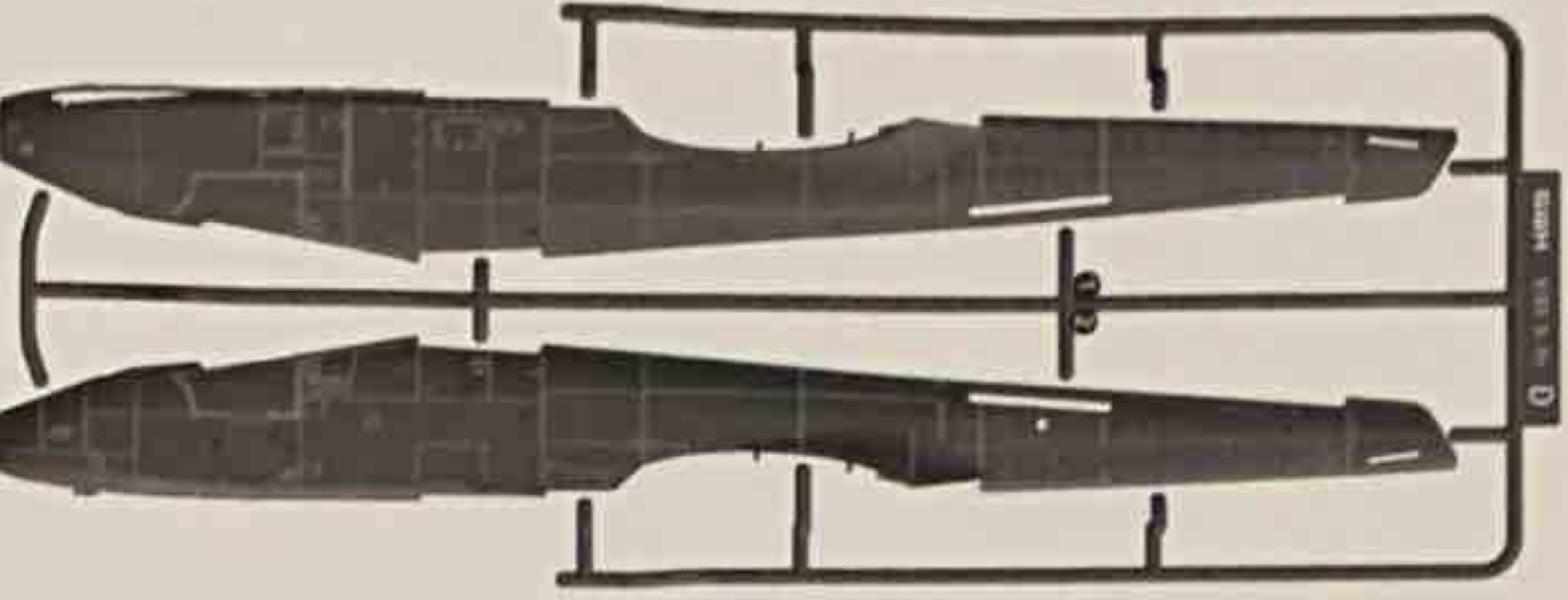

Q Part X1

R Part X1

AGM-65 Part X2

S Part X1

AIM-9L Part X2

AN/AO-184 Part X1

PE

Decal A

MK83 Part X1

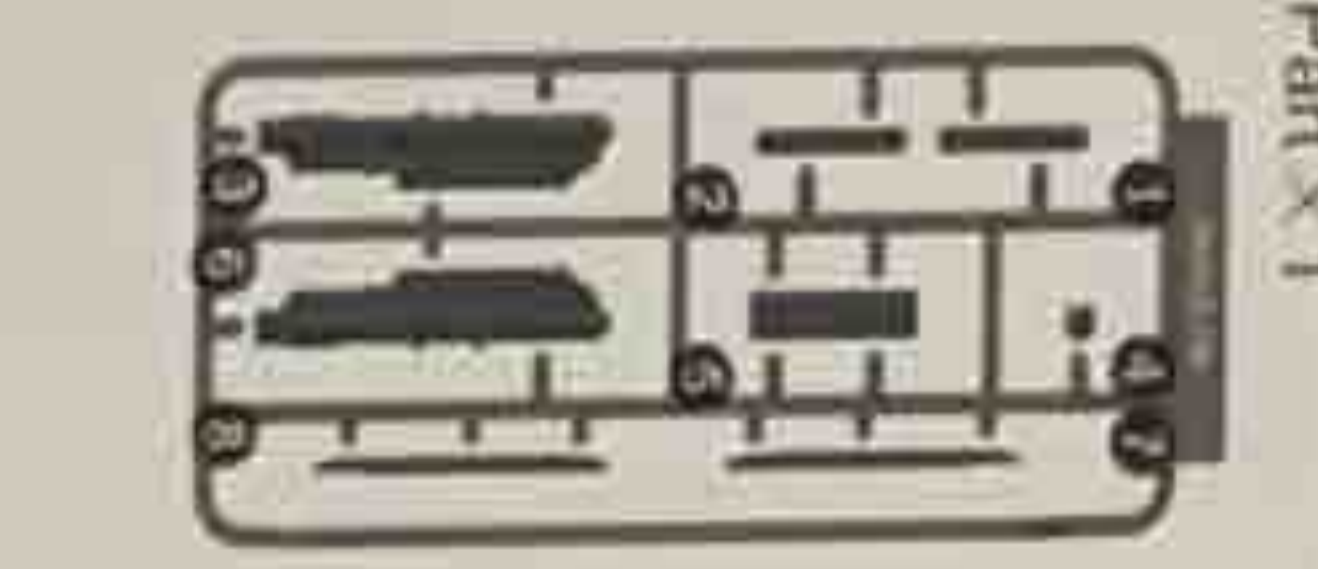
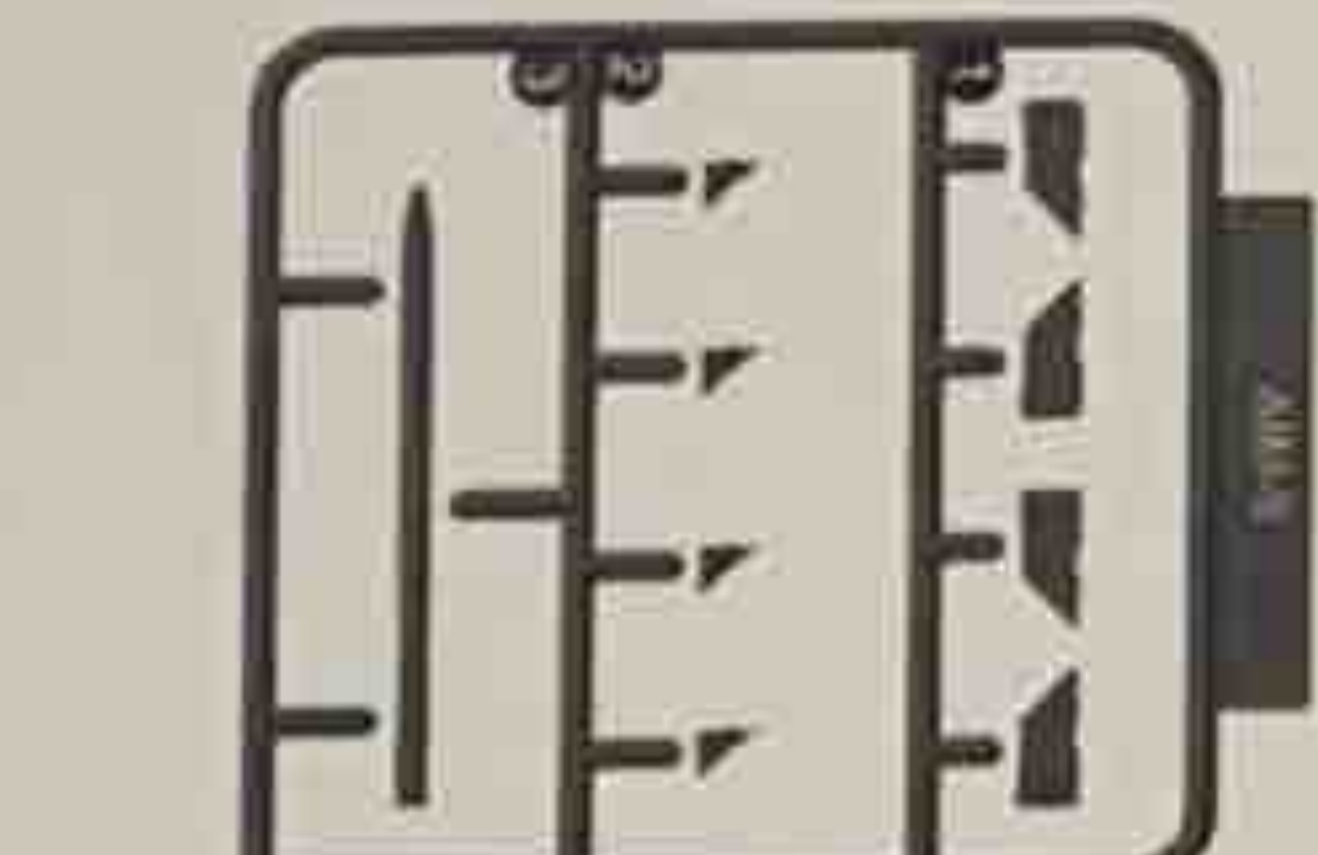
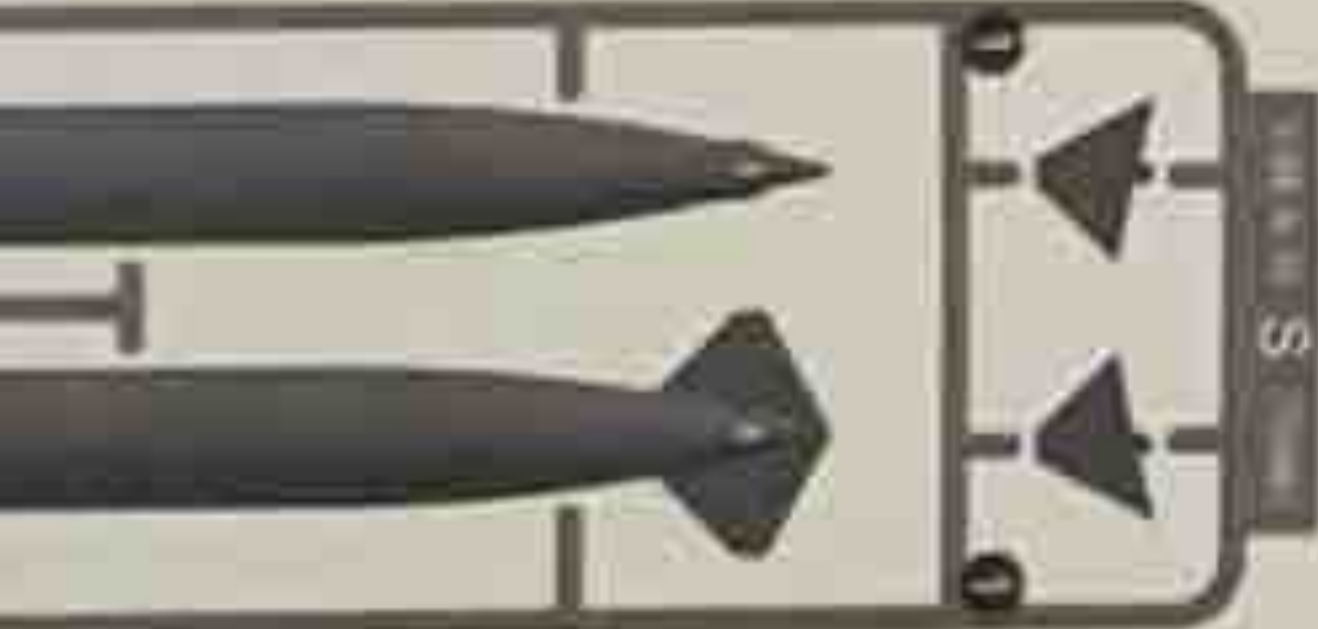
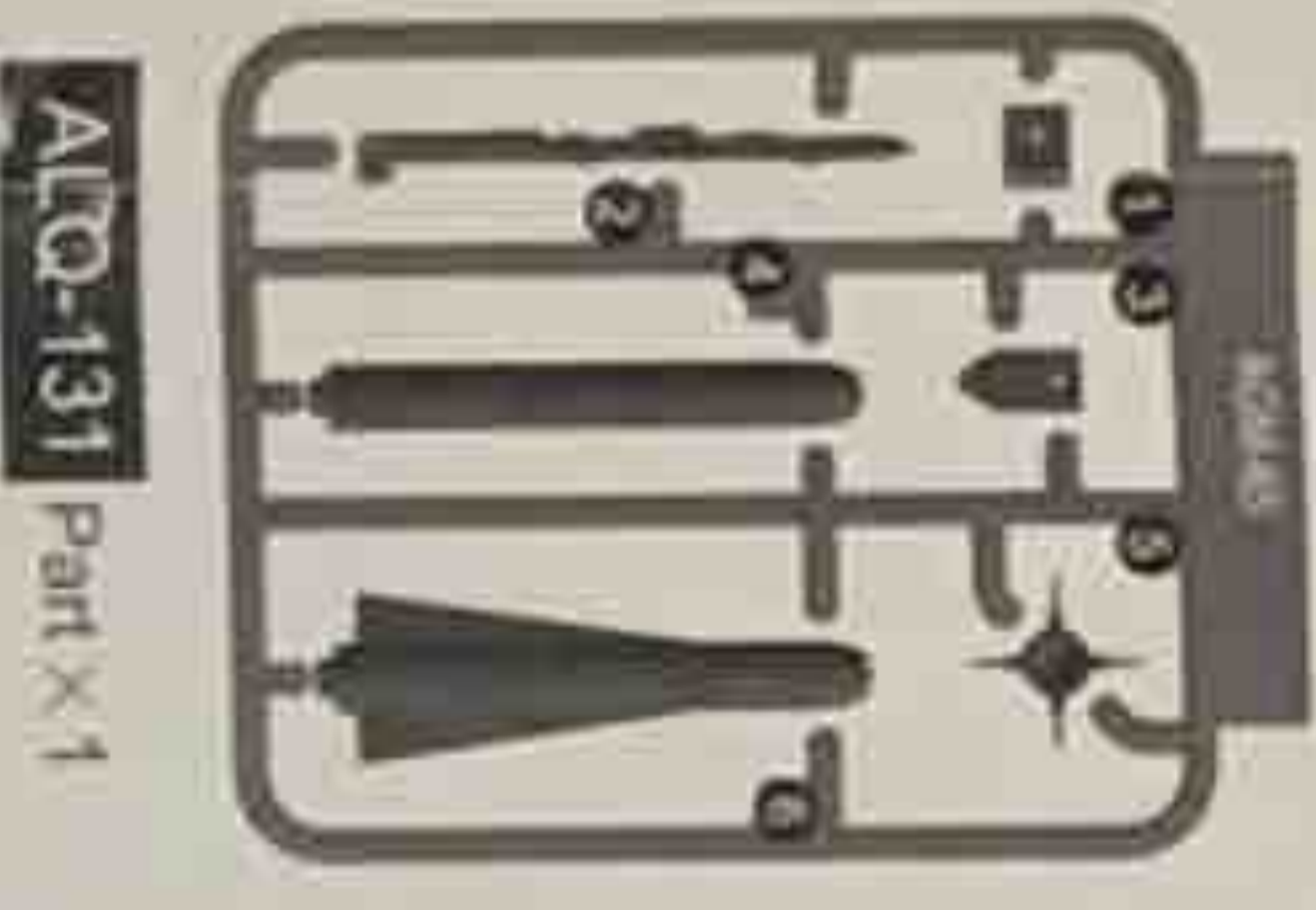
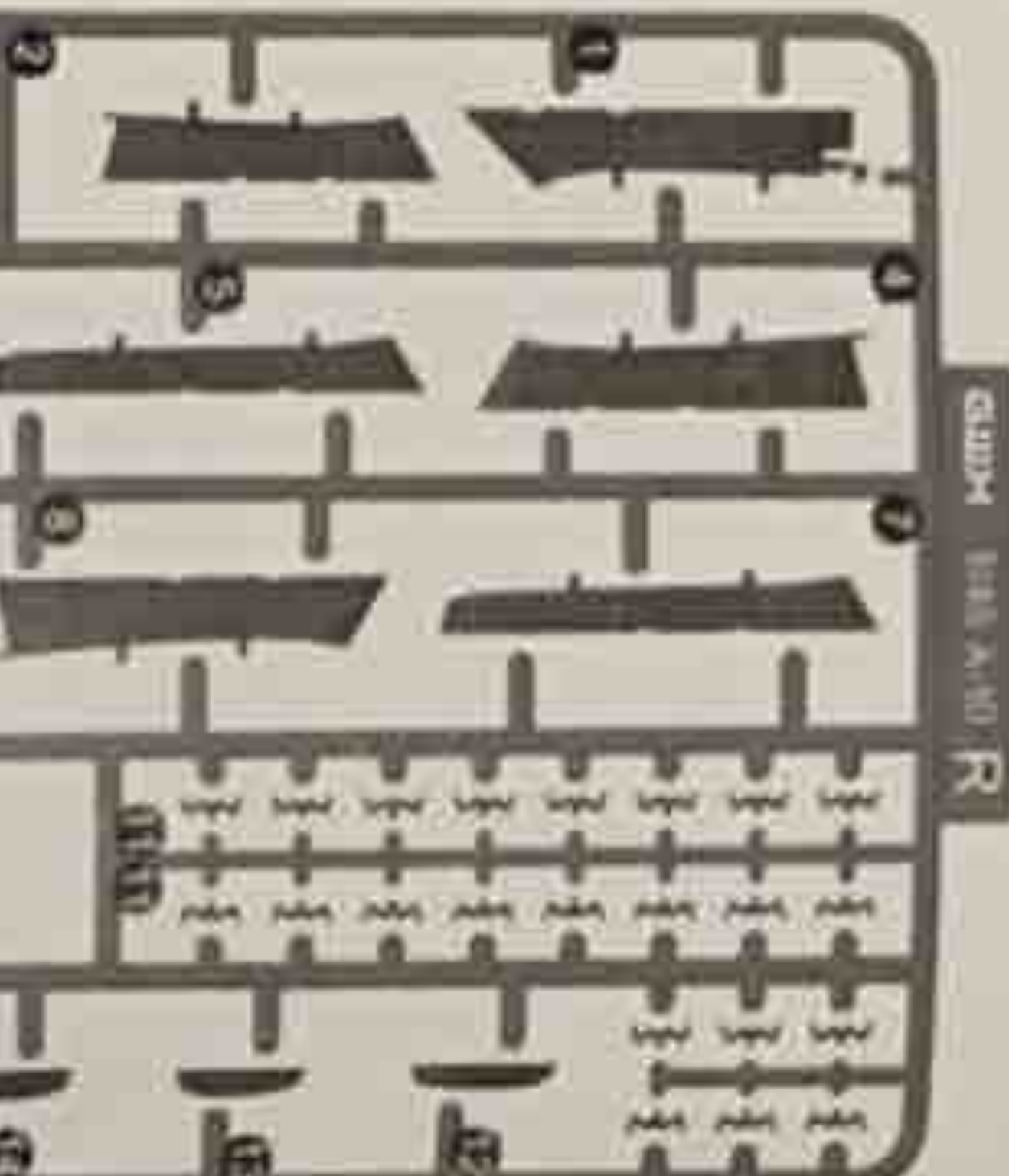
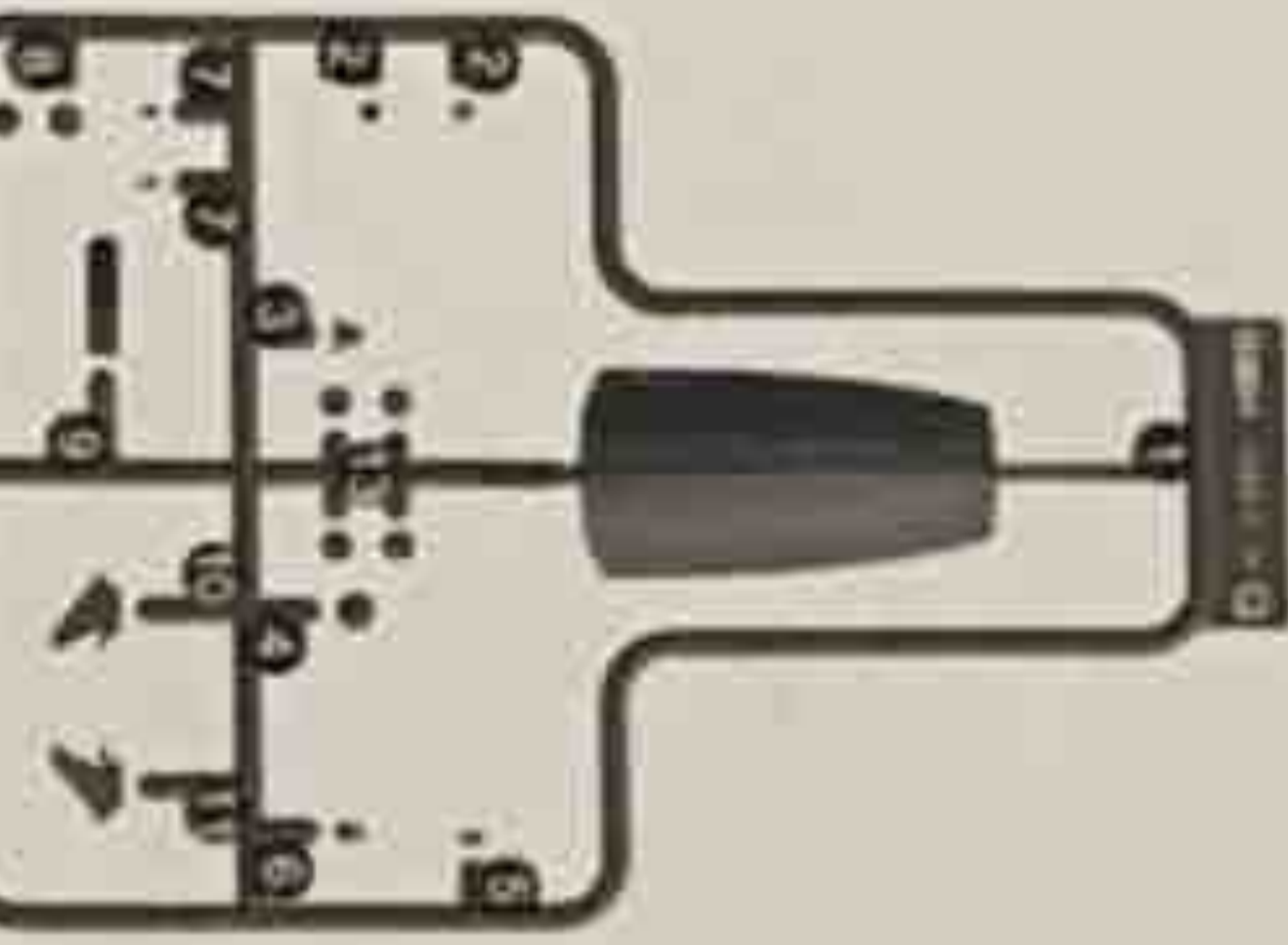

MK83 Part X1

ALQ-131 Part X1

AIM-9L Part X2

AN/AO-184 Part X1

PE

Decal B

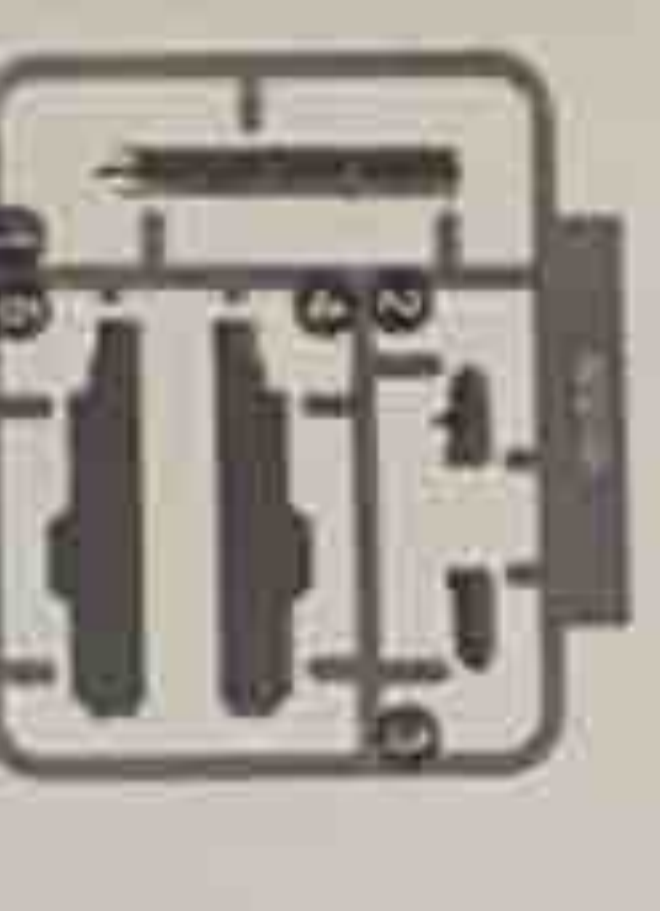
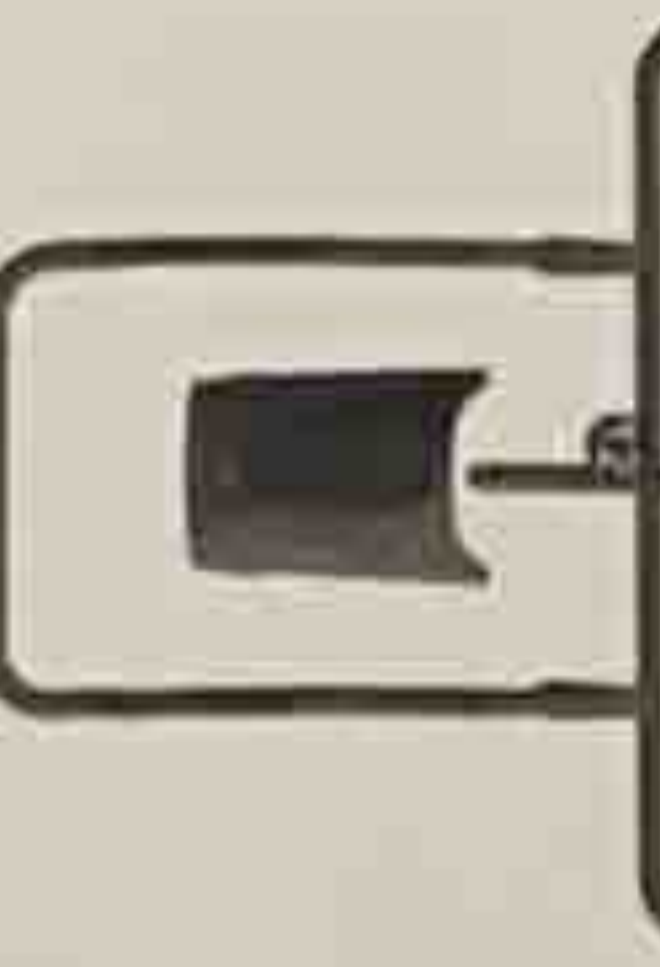

阴影零件不使用
DO NOT USE THE
SHADOW PARTS

SPECIAL WEIGHT



1

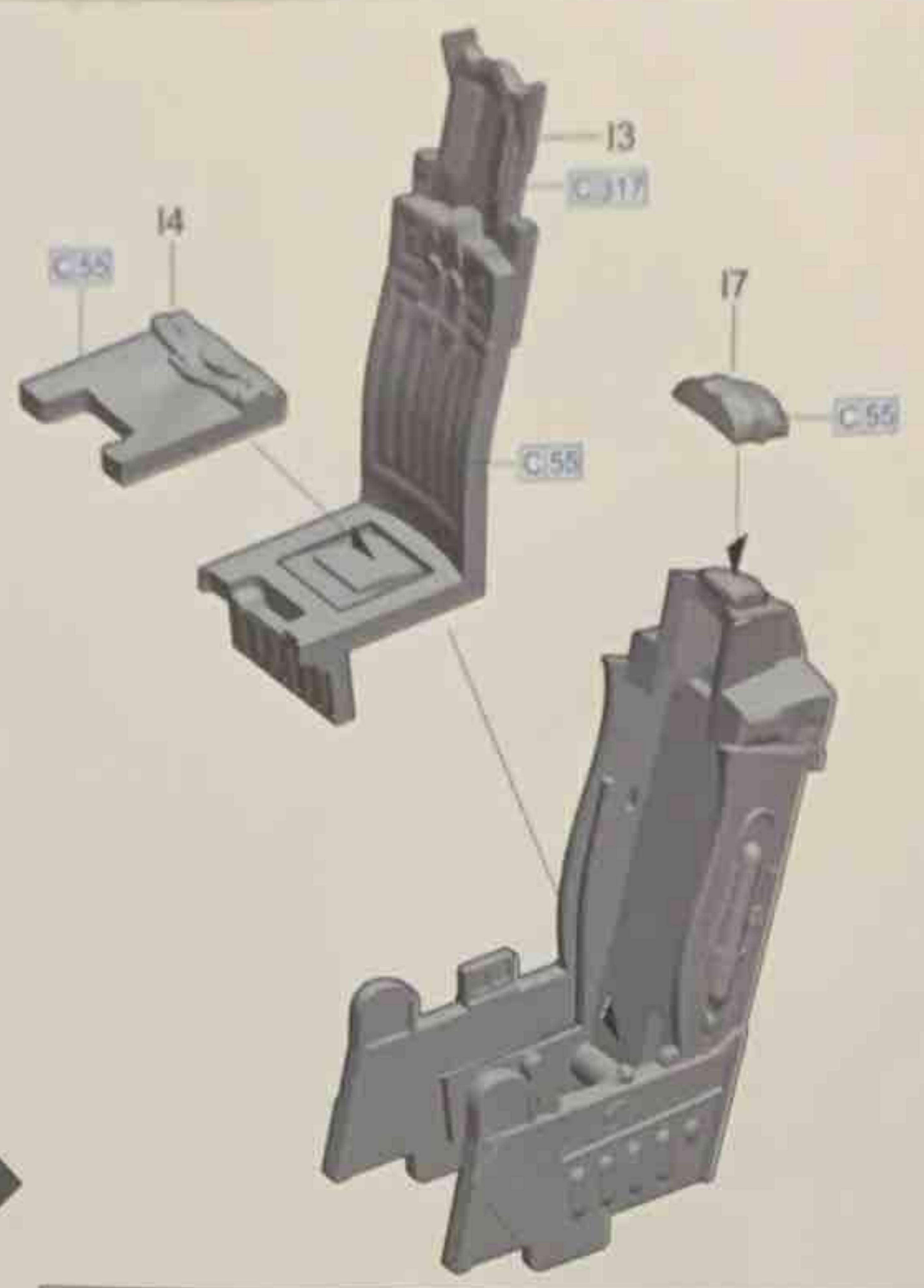
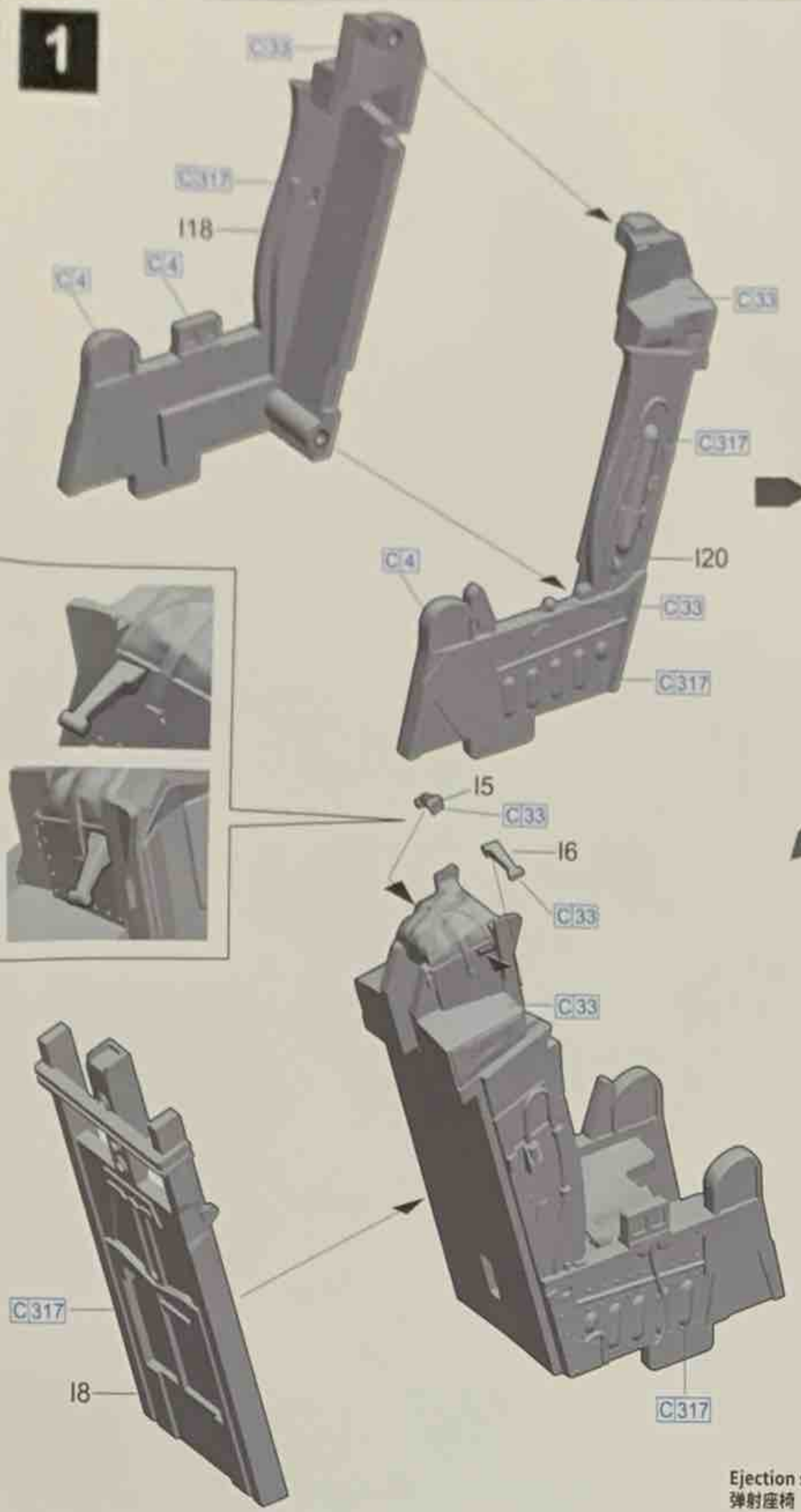

Ejection seat
弹射座椅

2

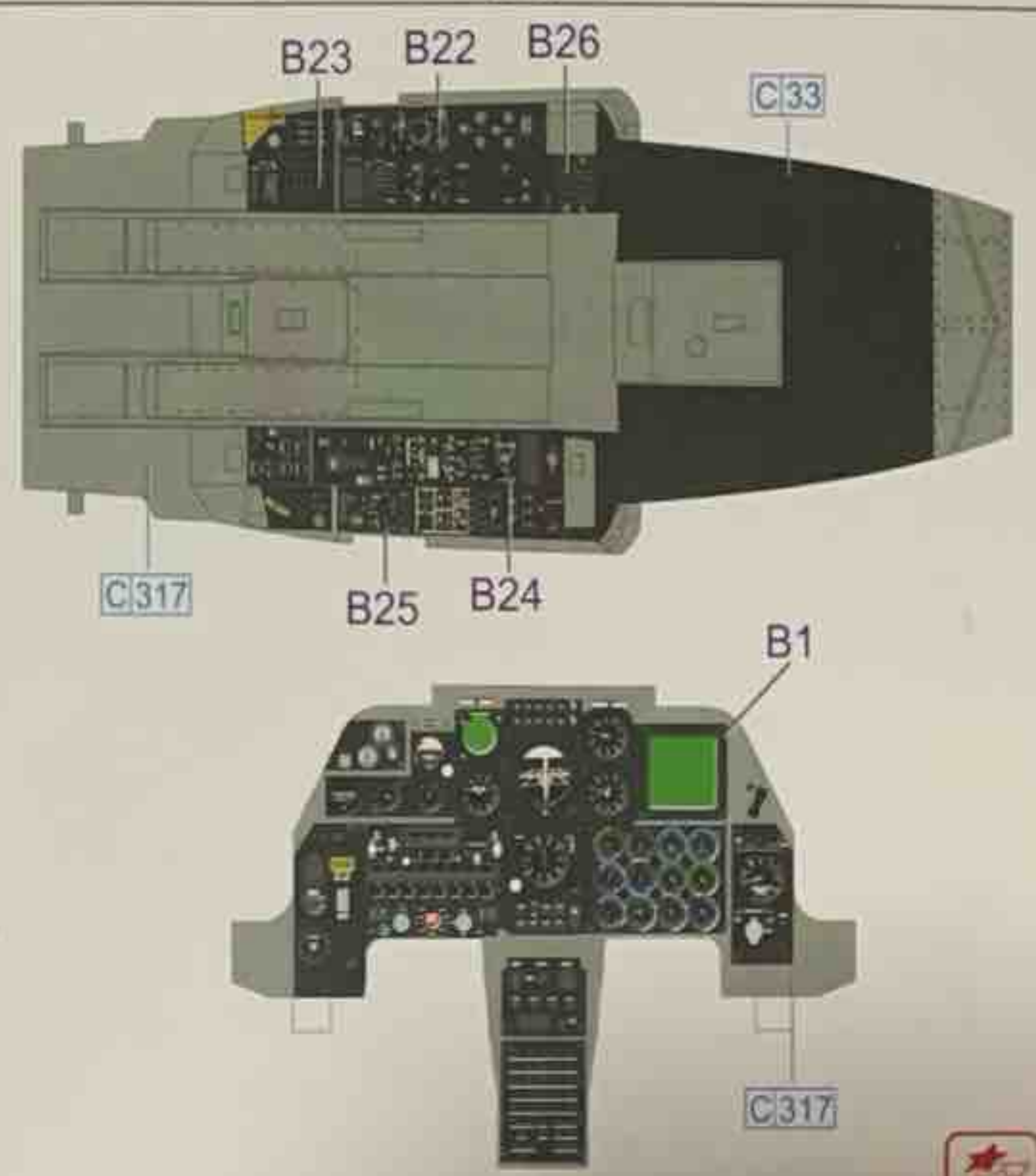
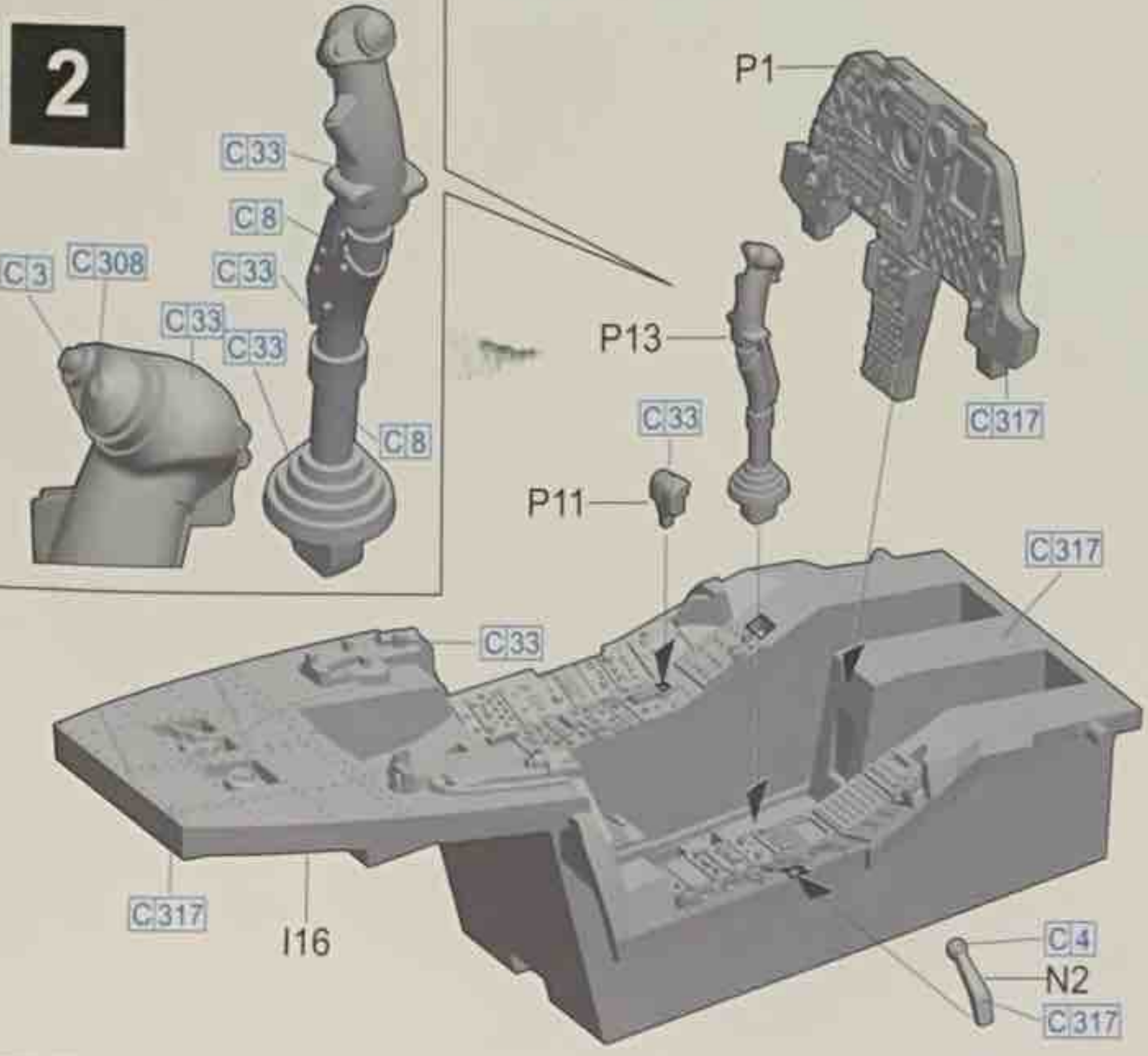

3

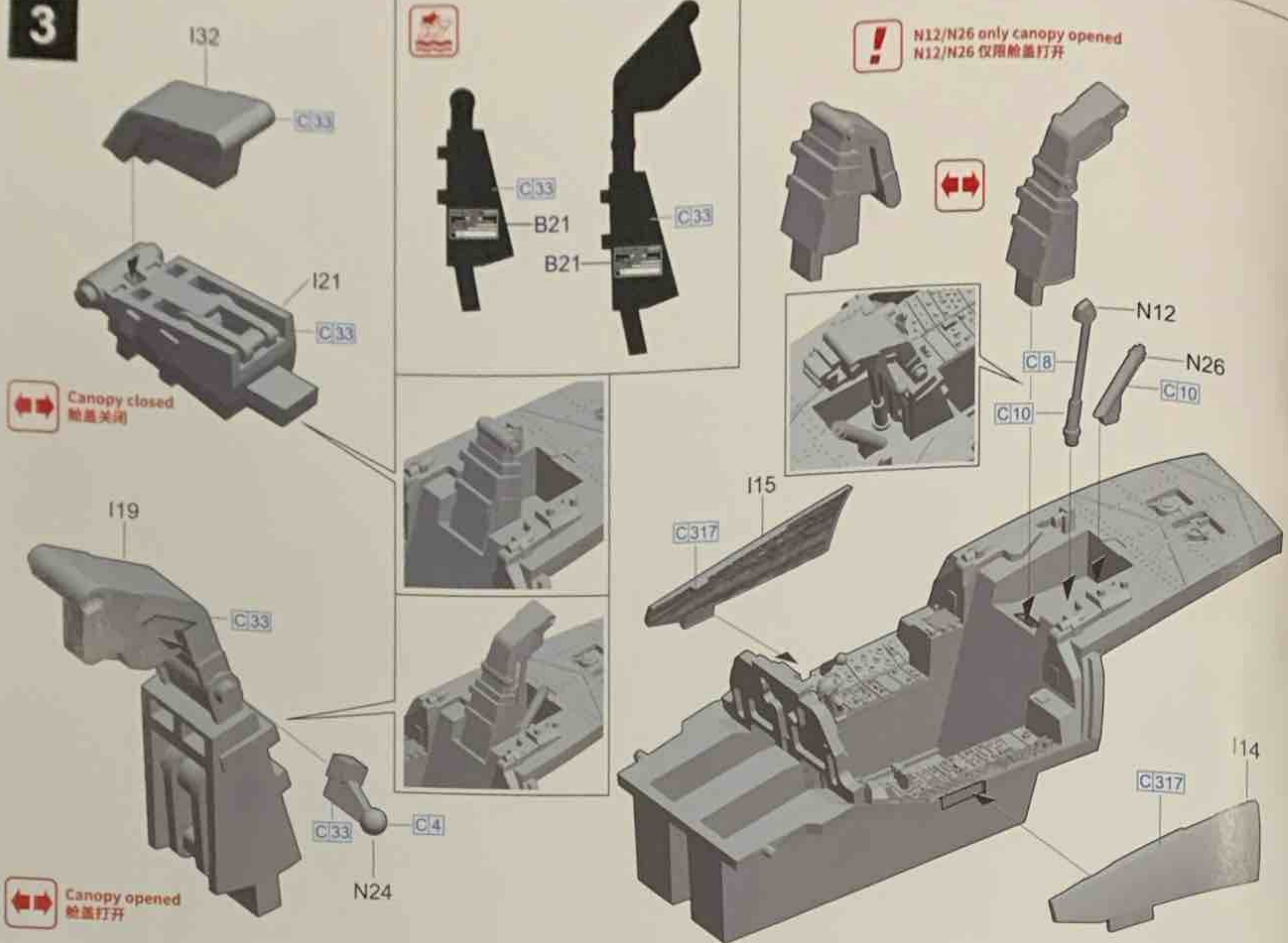

4

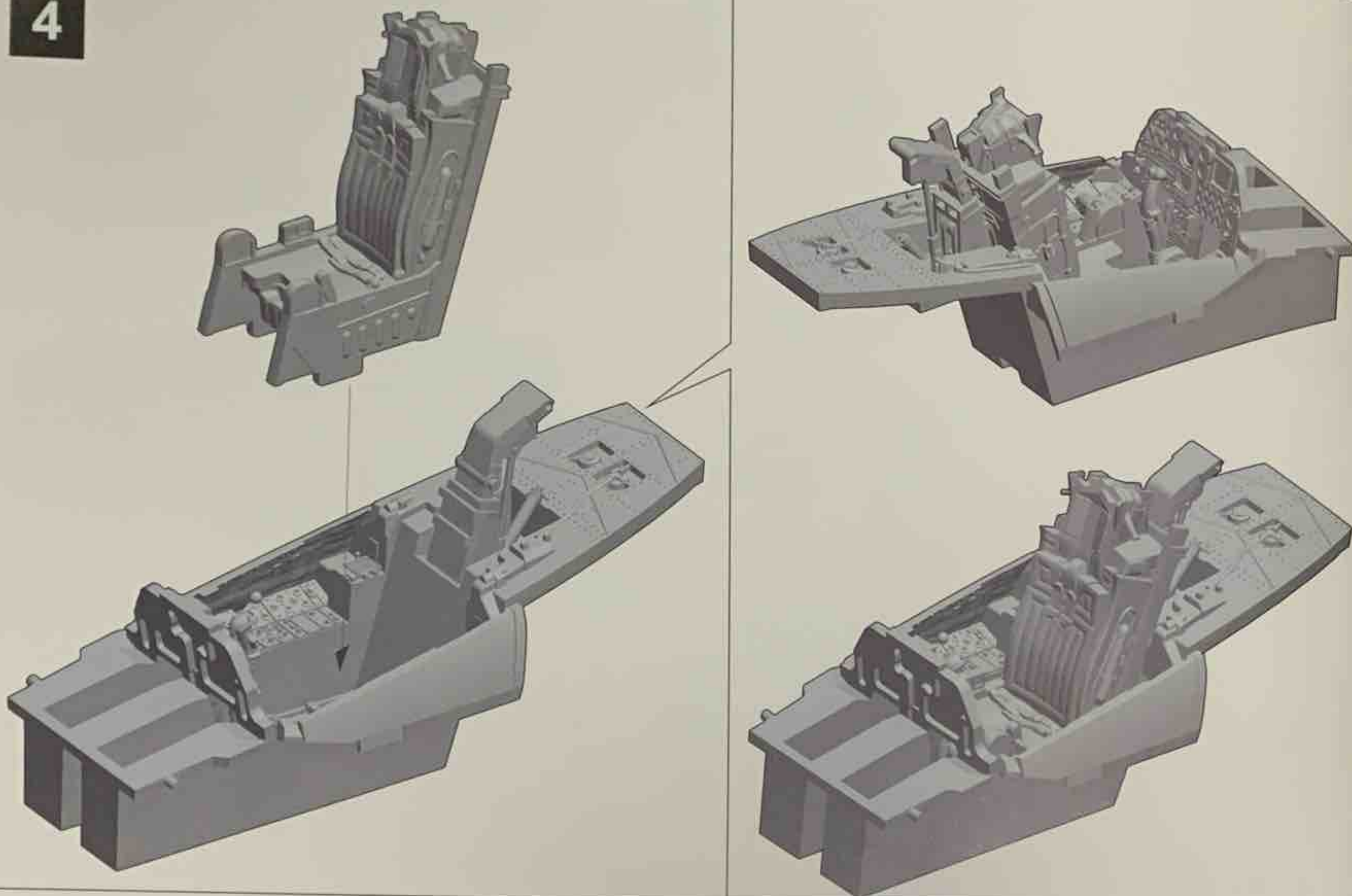

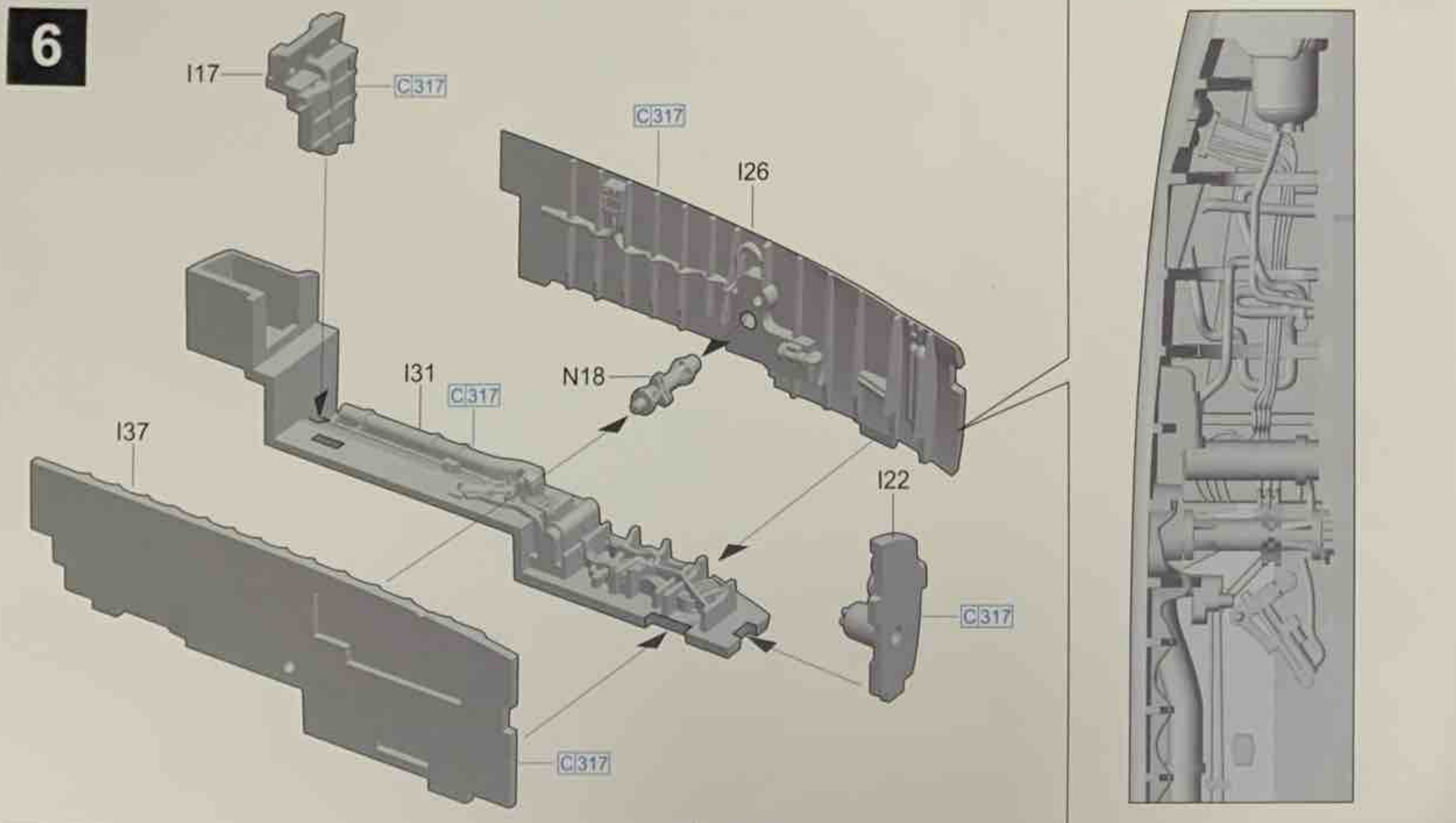
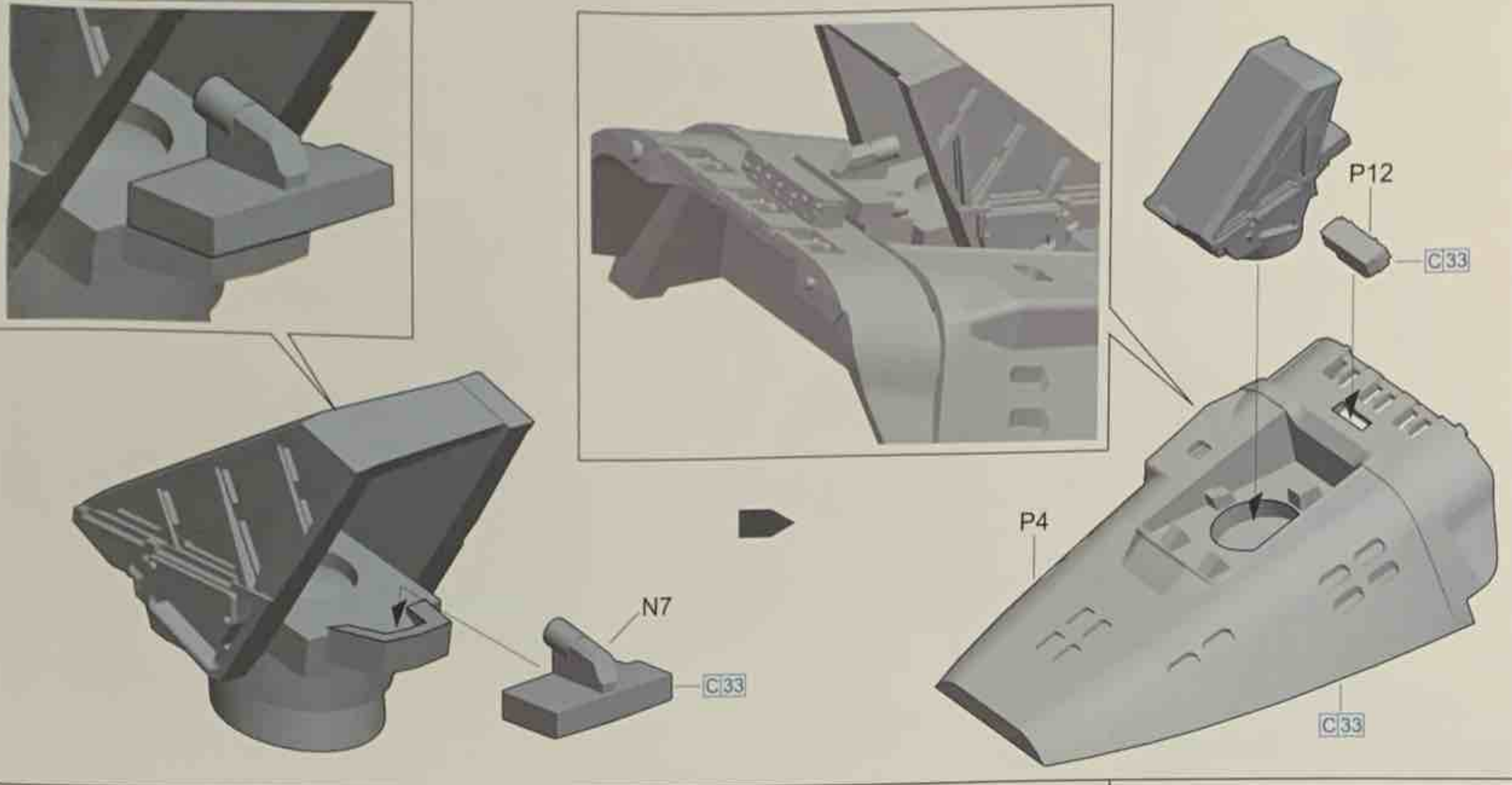
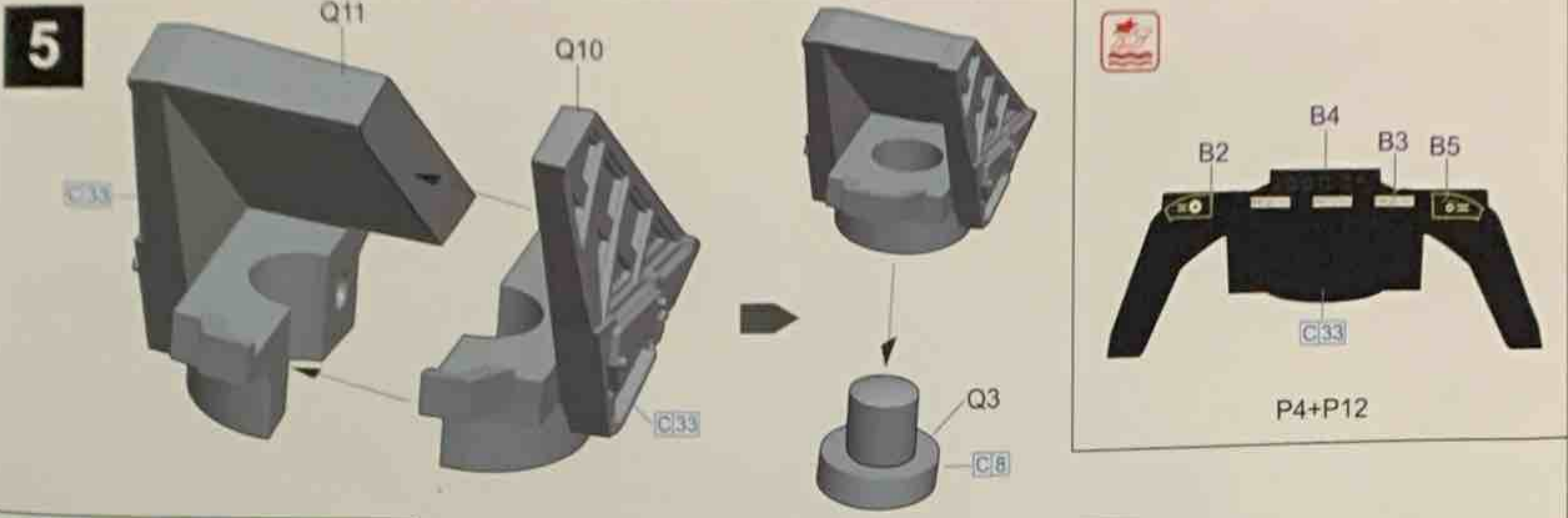

7

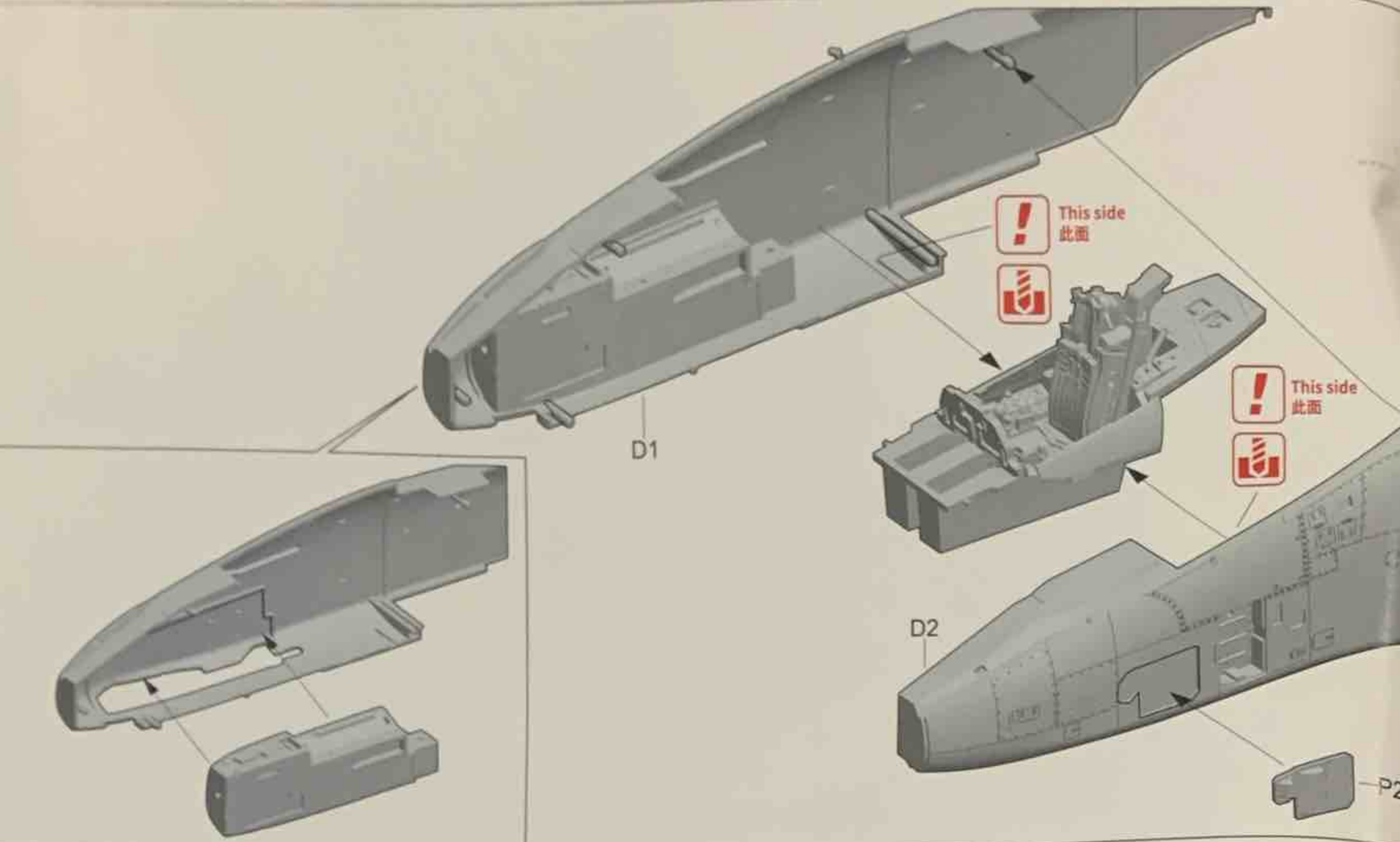
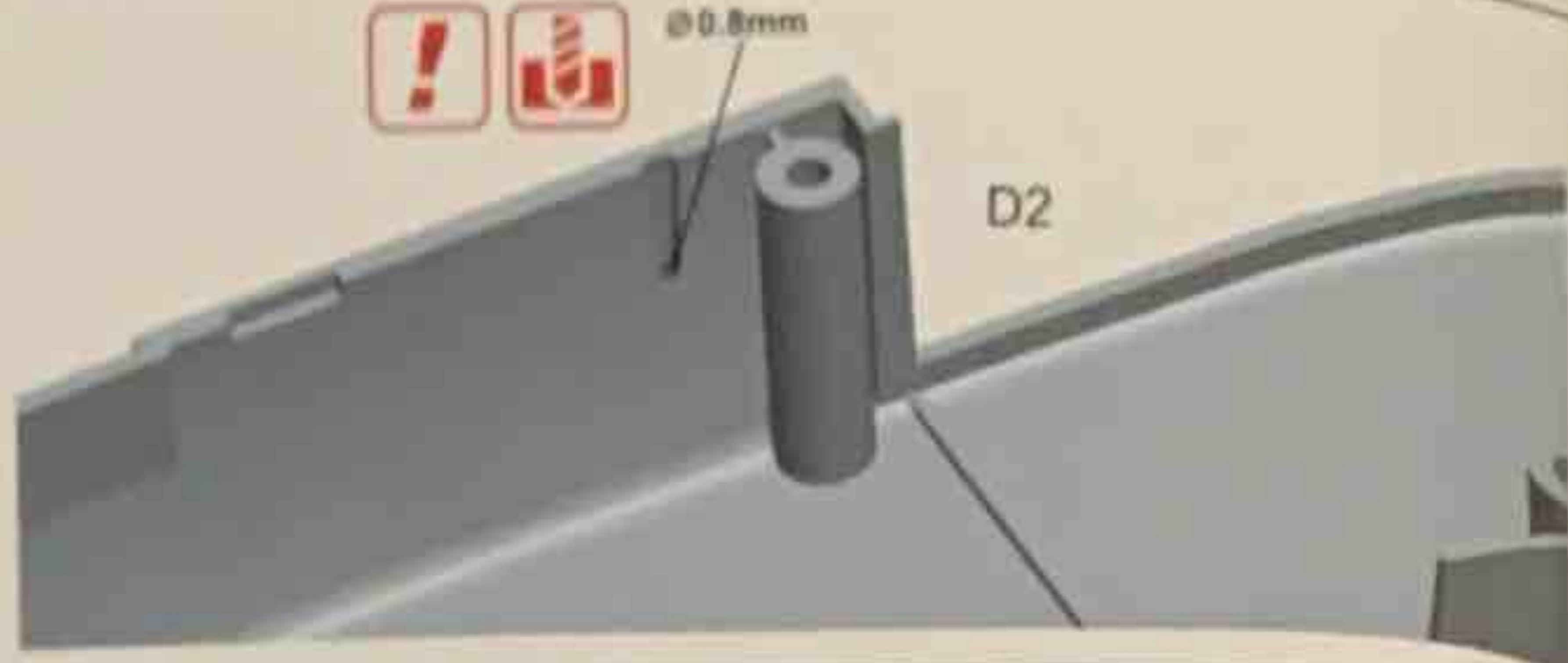
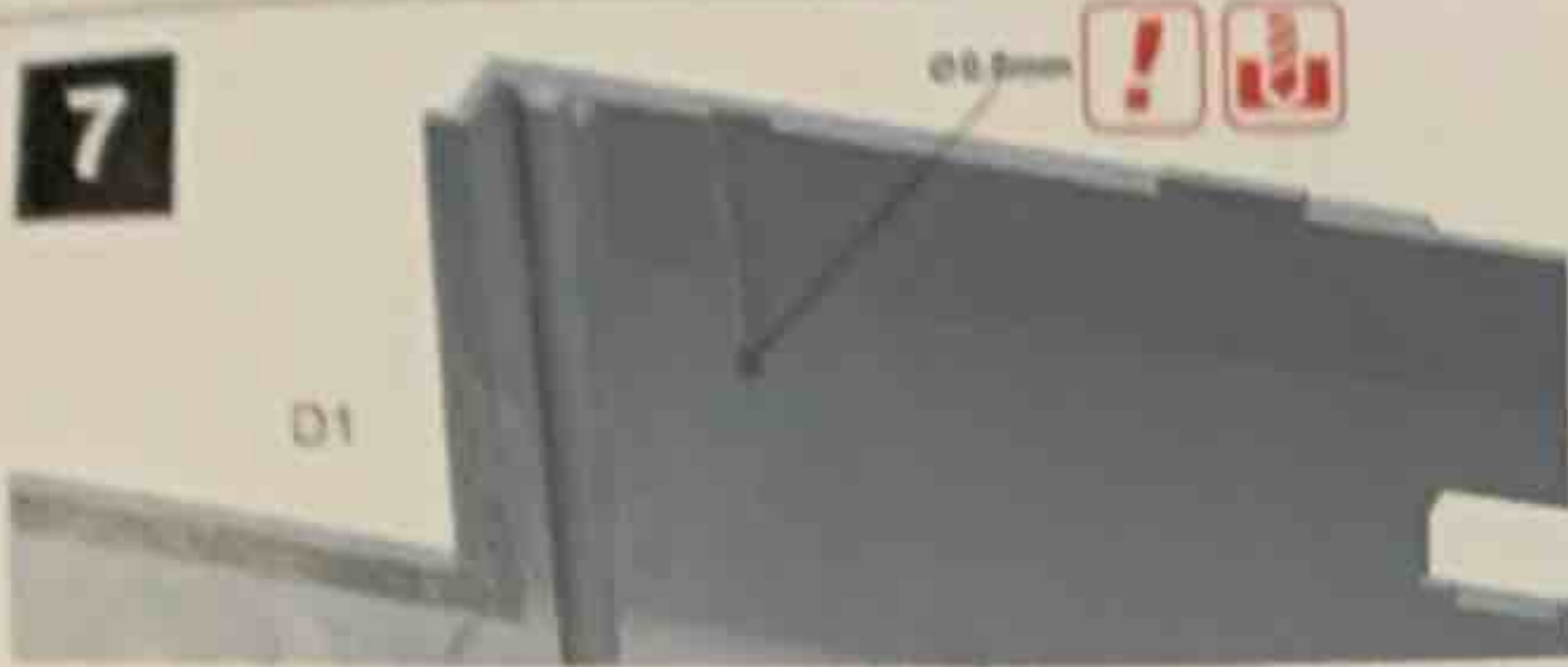

8

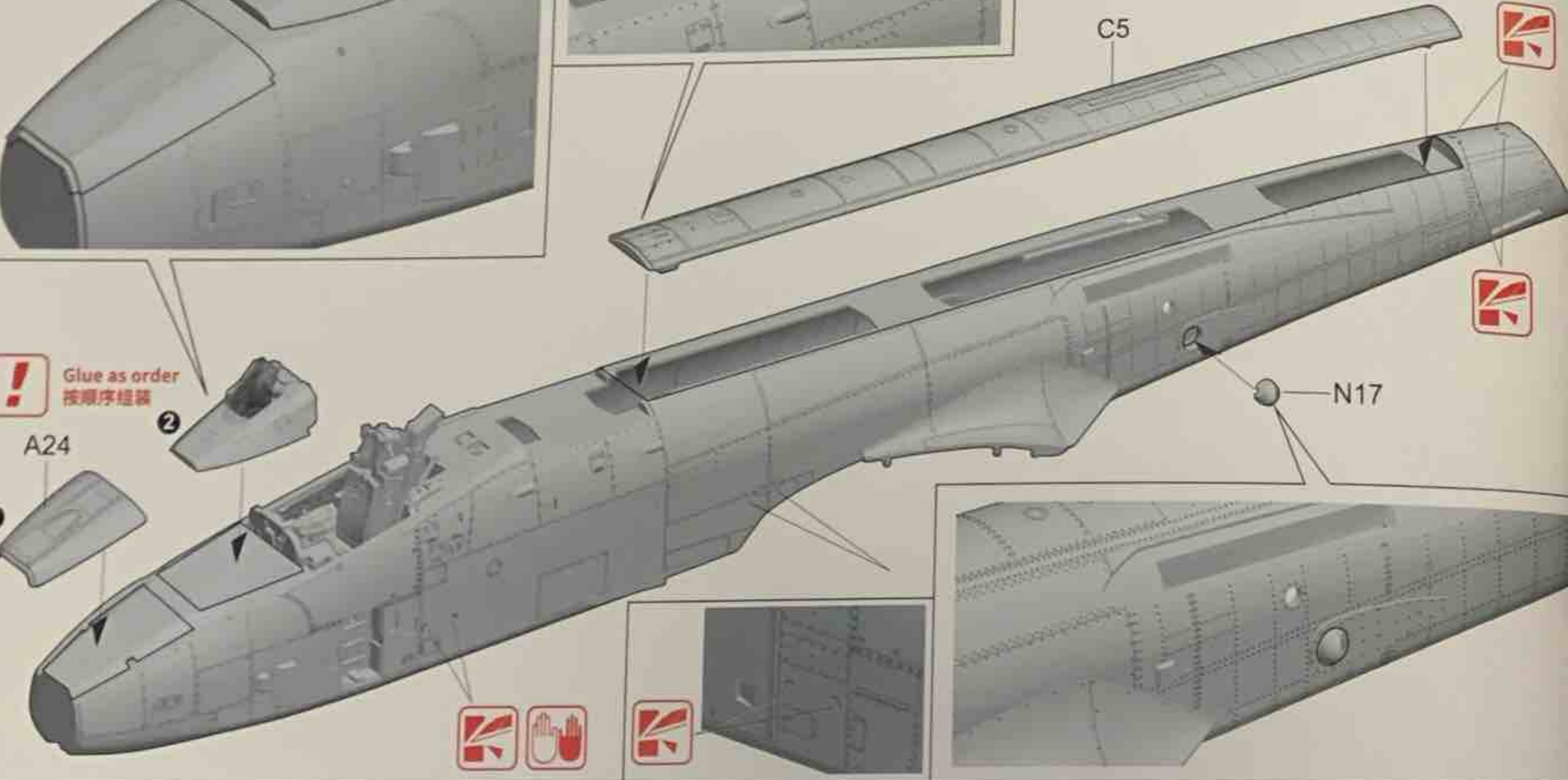
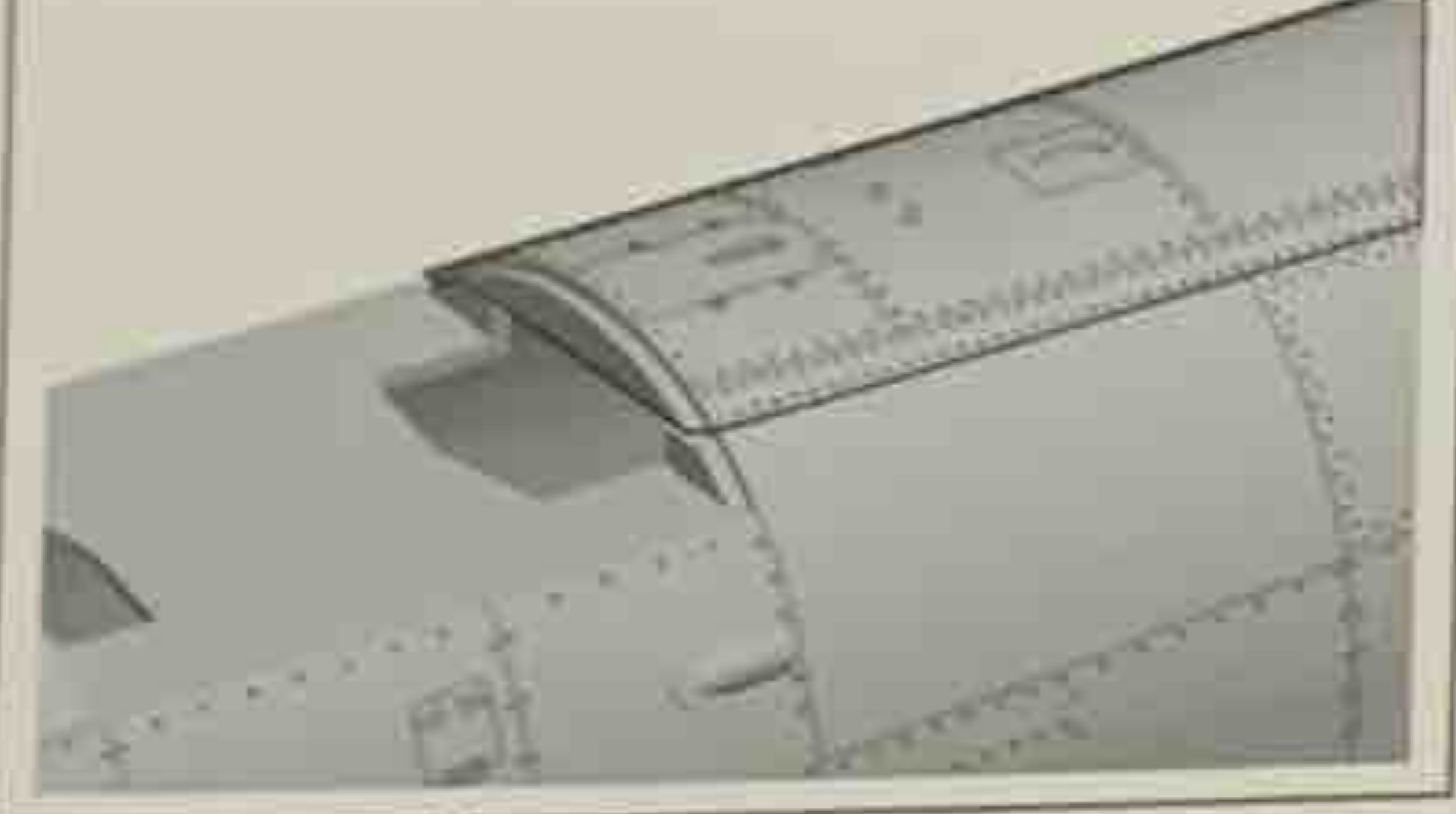
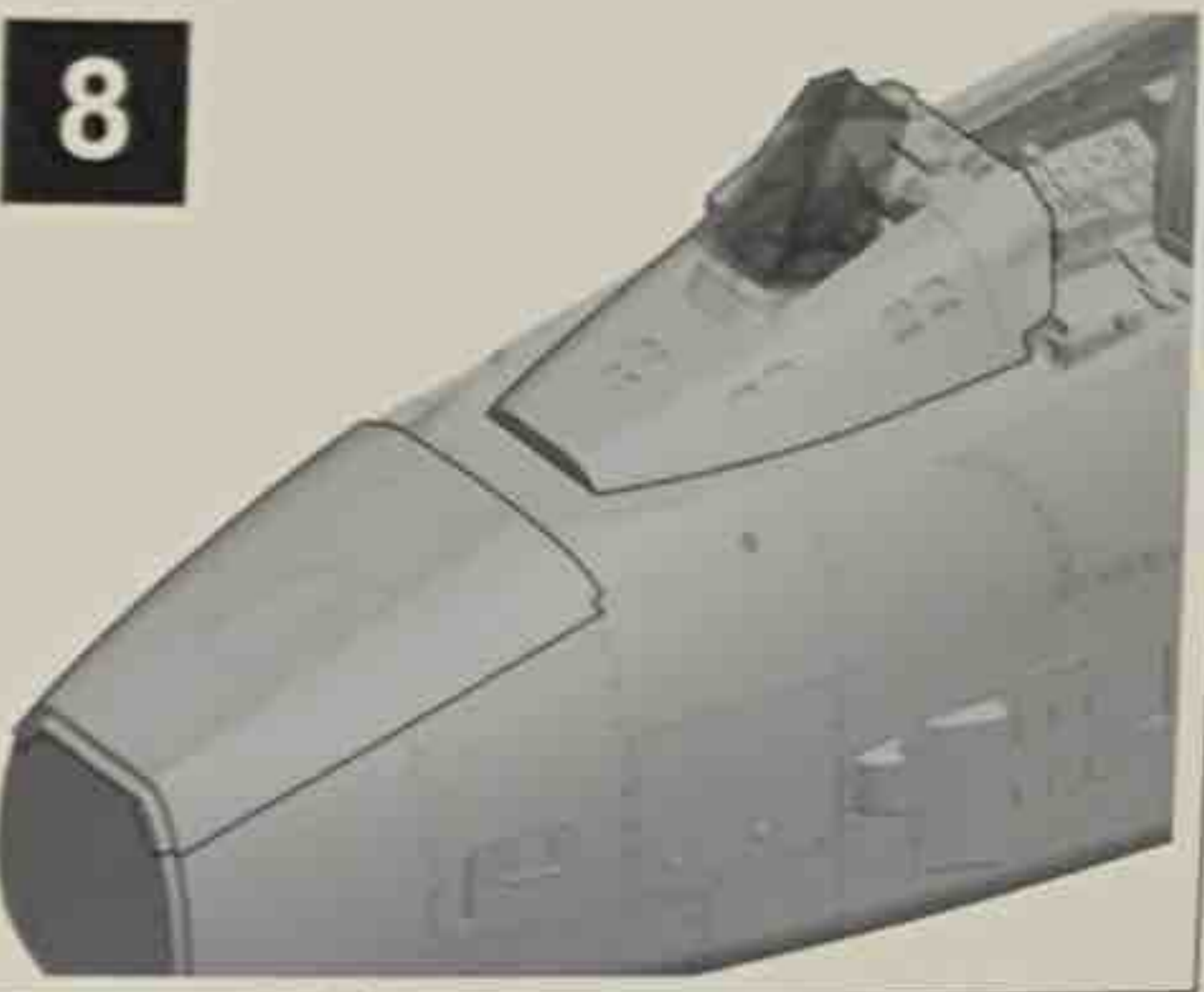

9

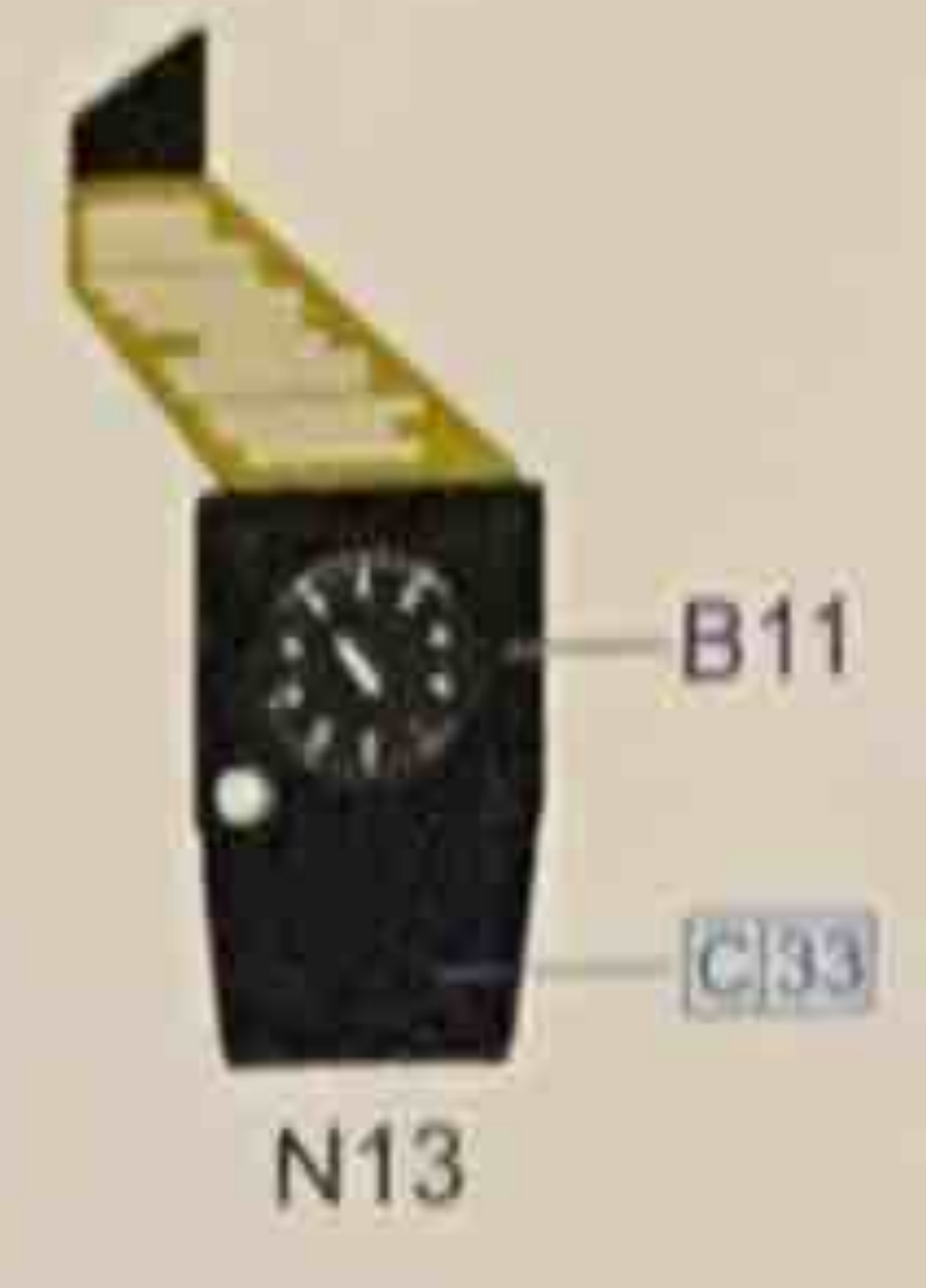

10

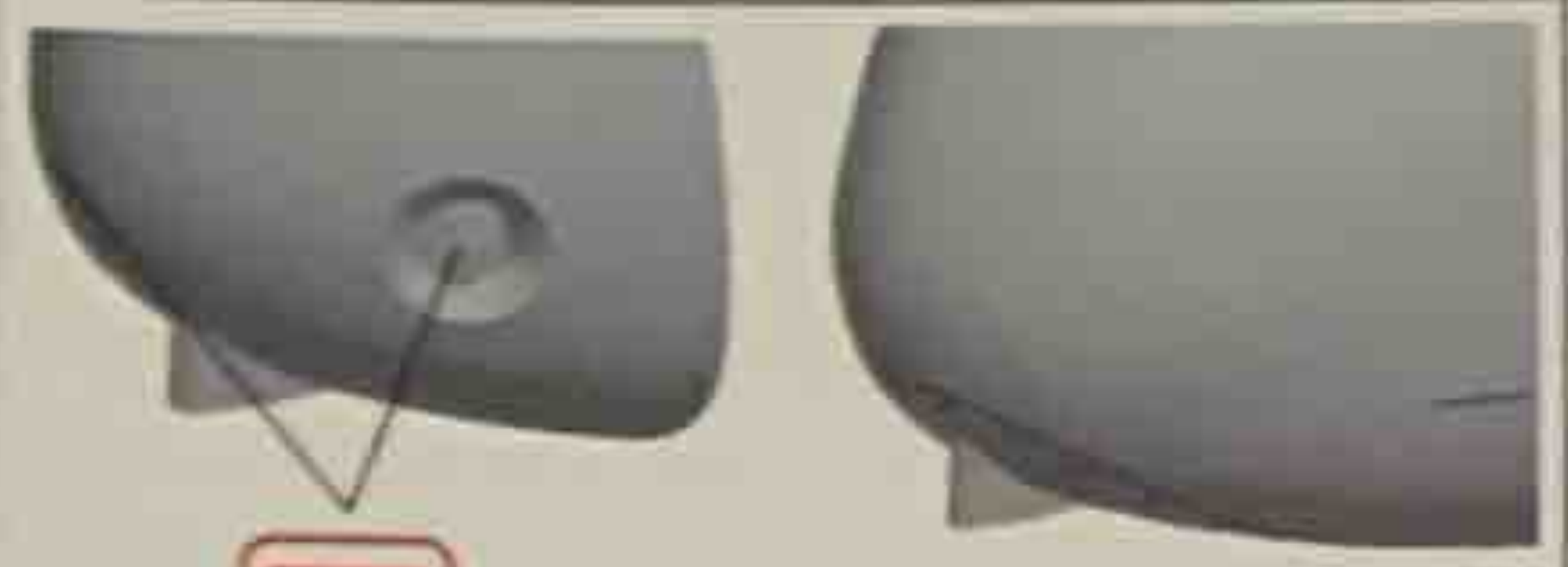
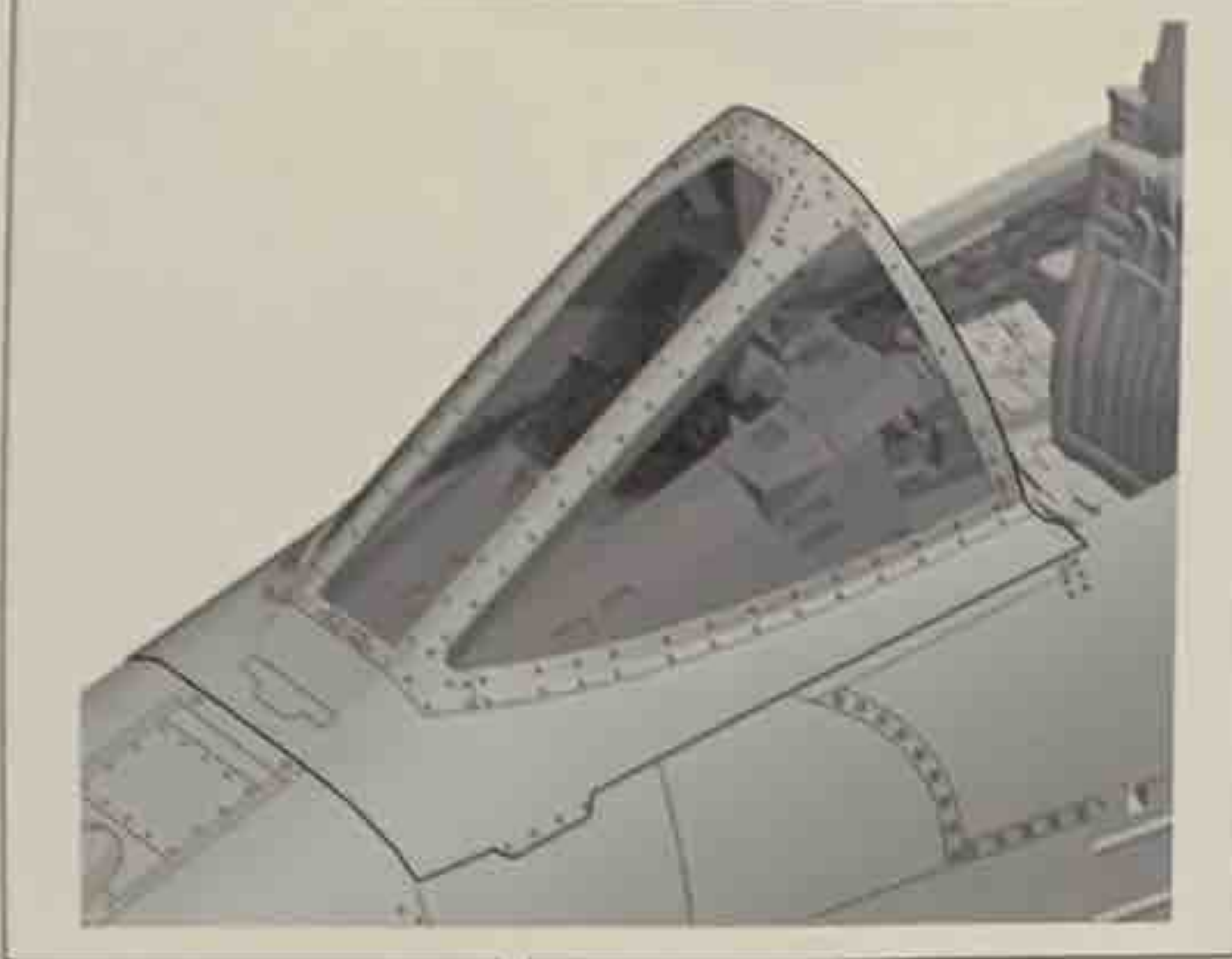
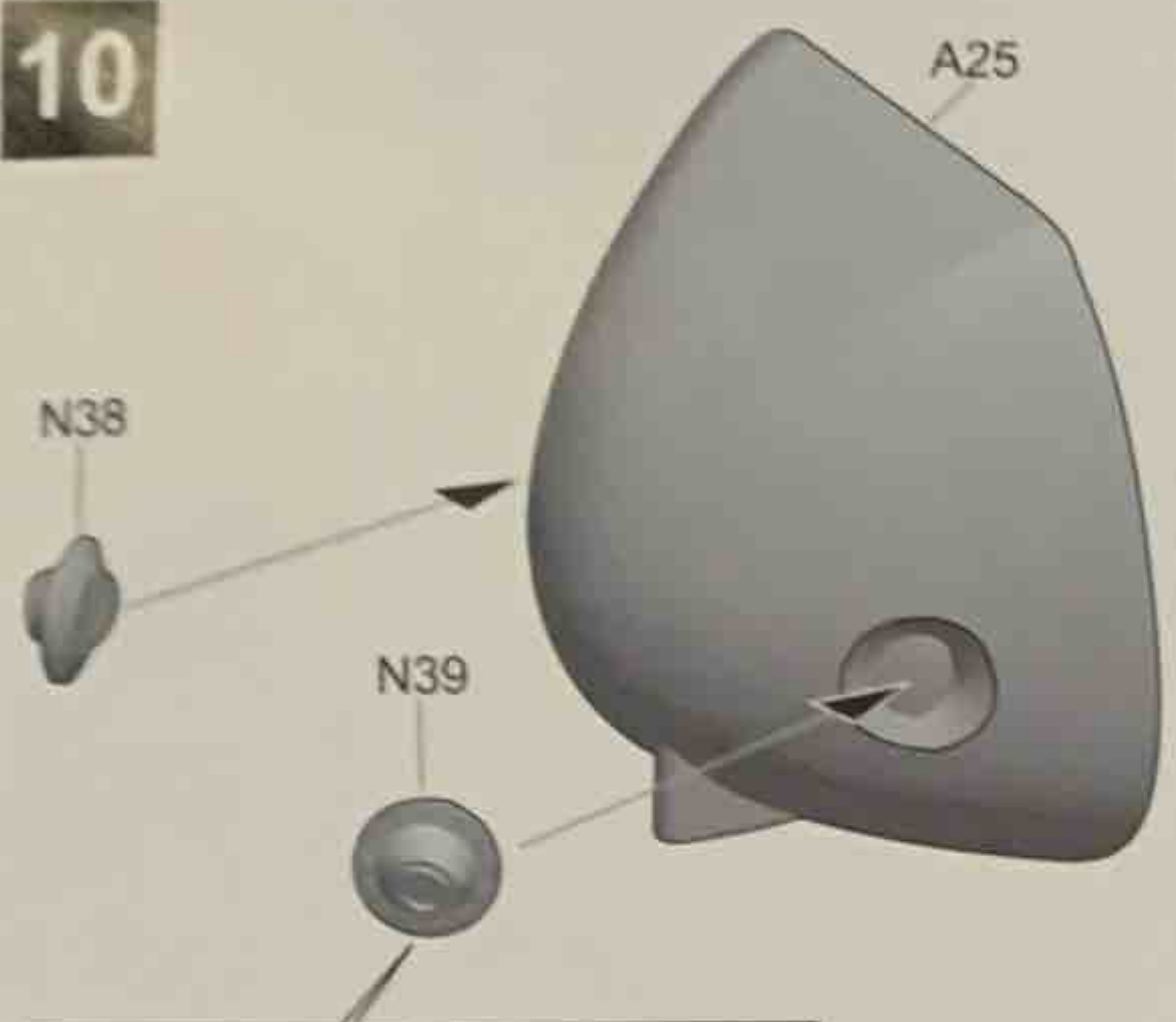

! Only for painting scheme B
仅限涂装B

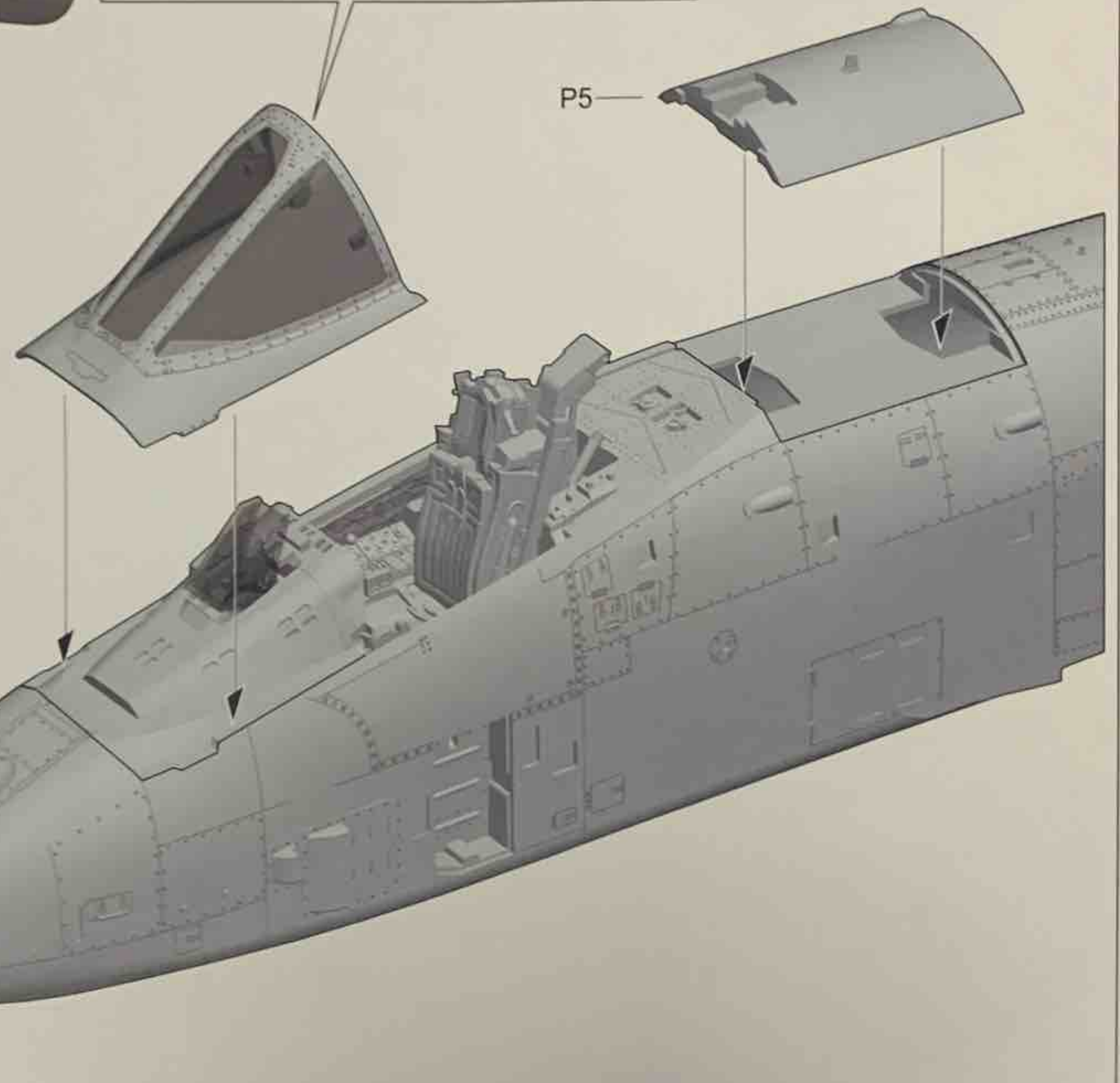

11

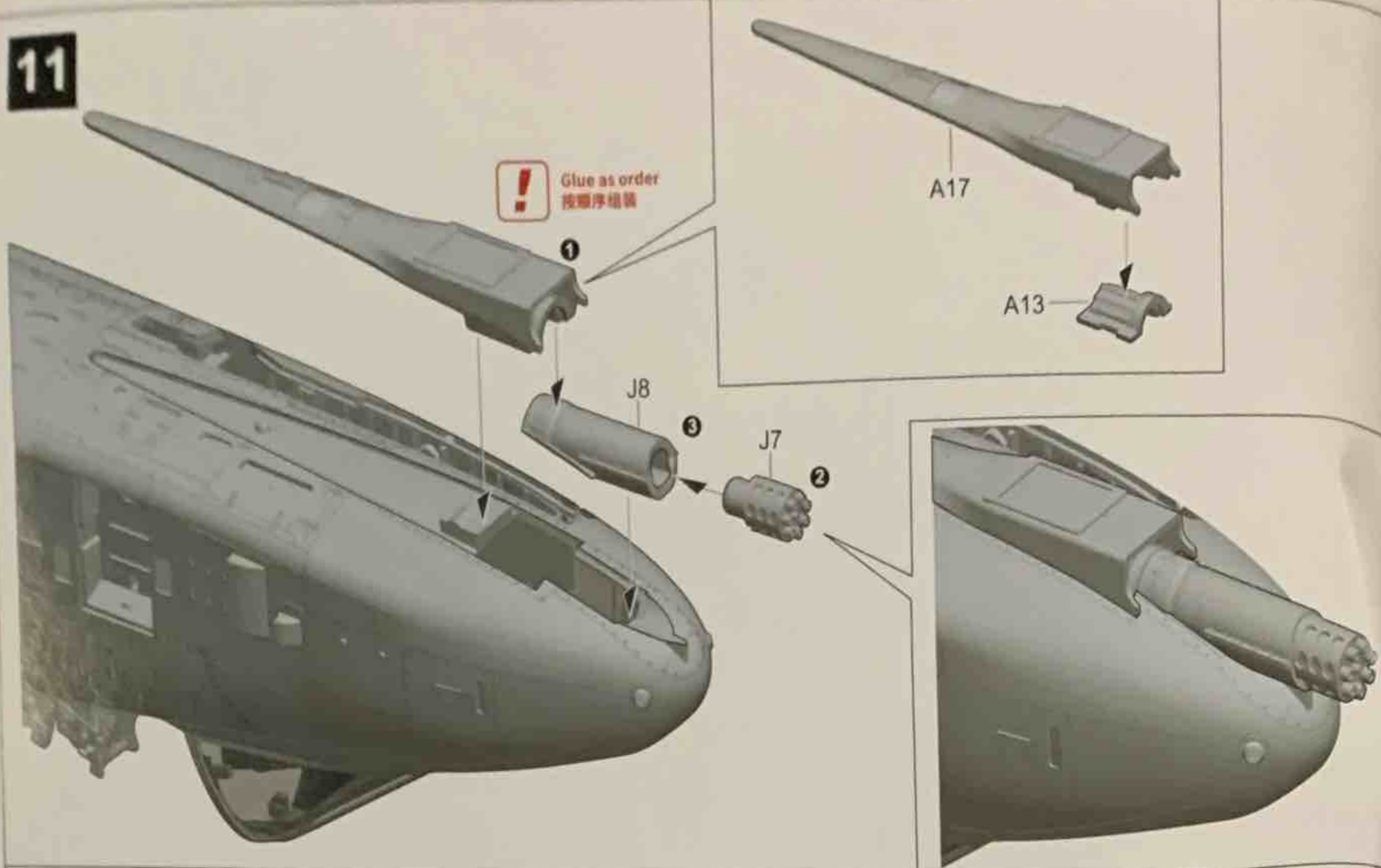

12

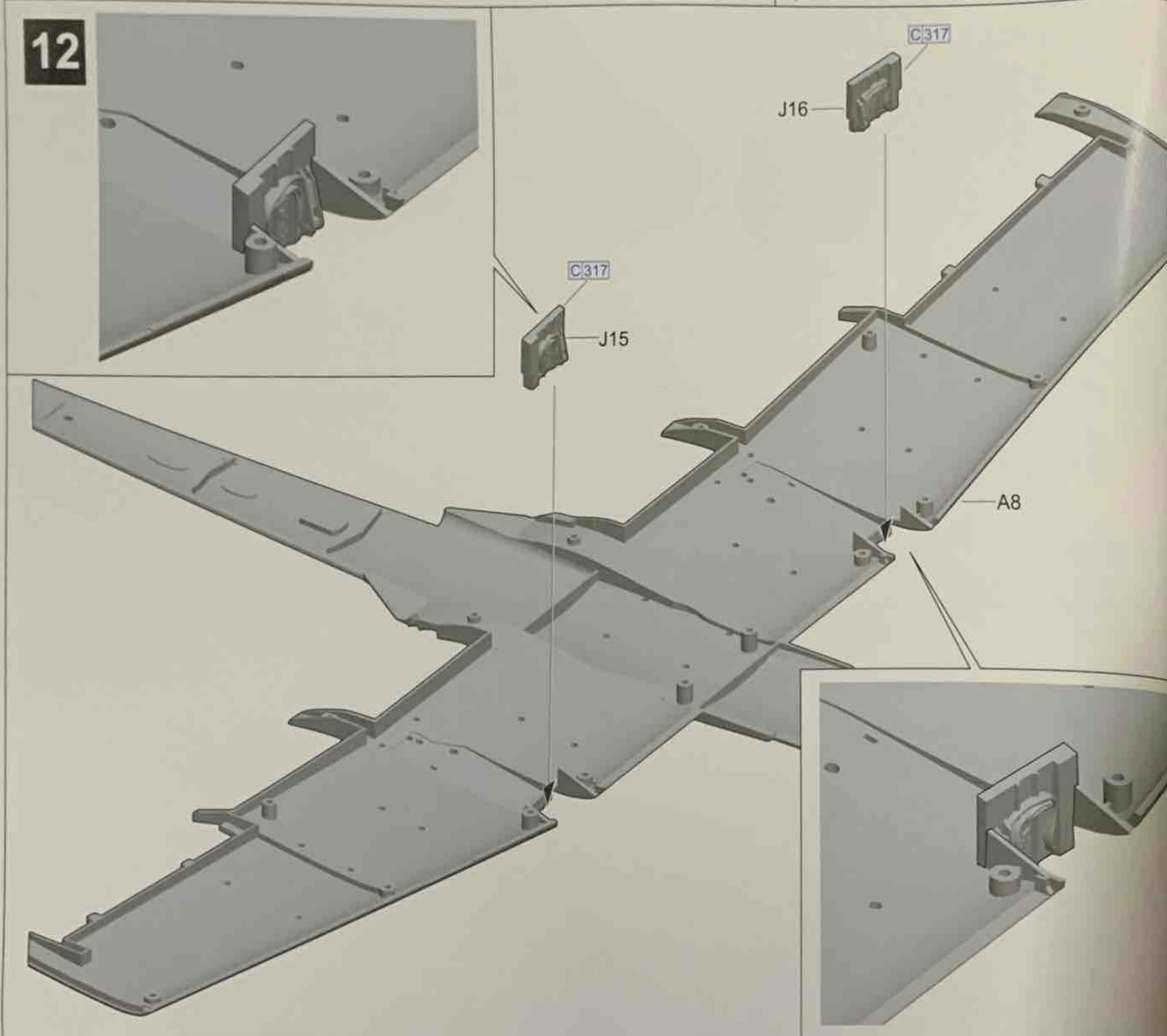

13

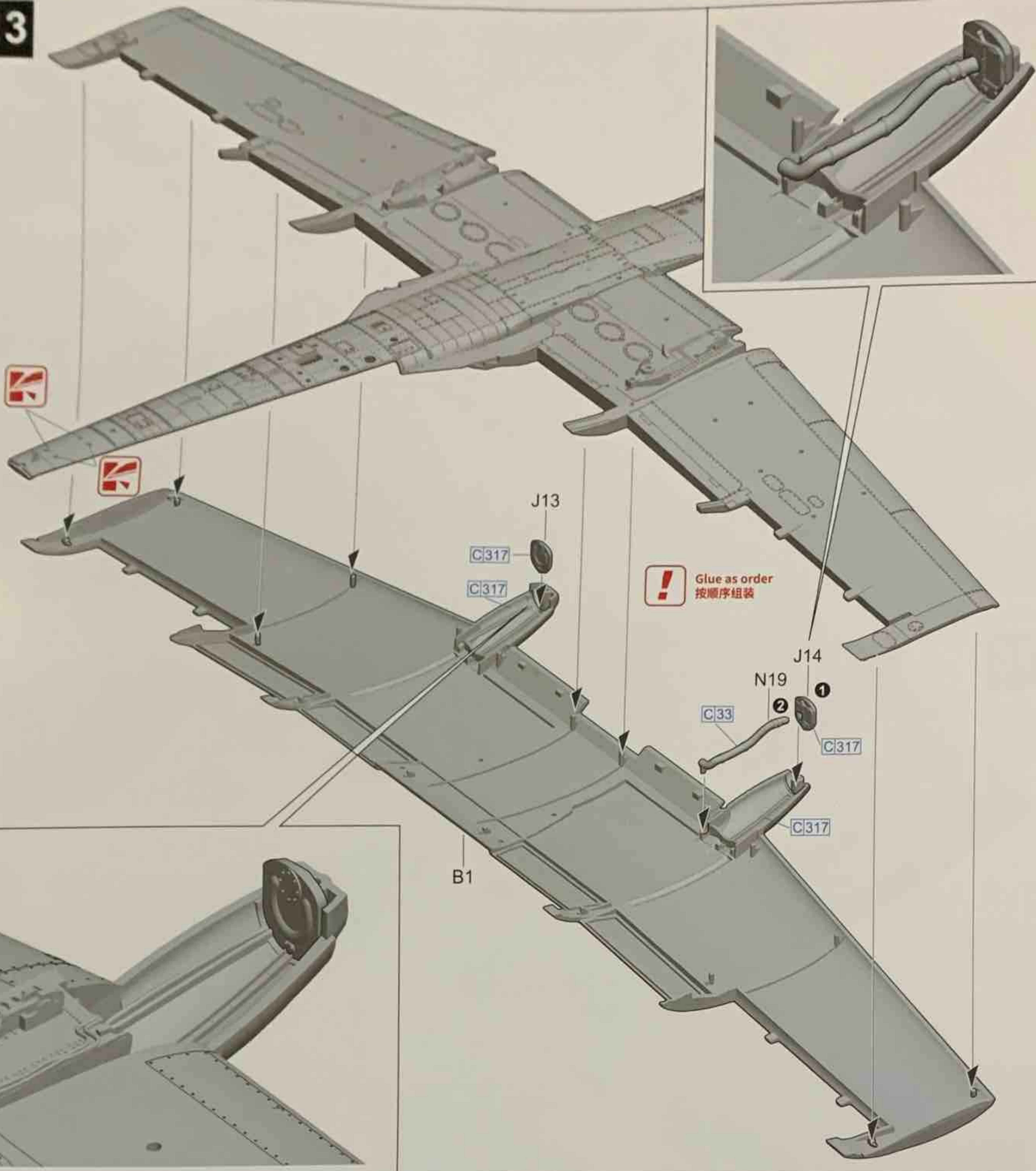

14

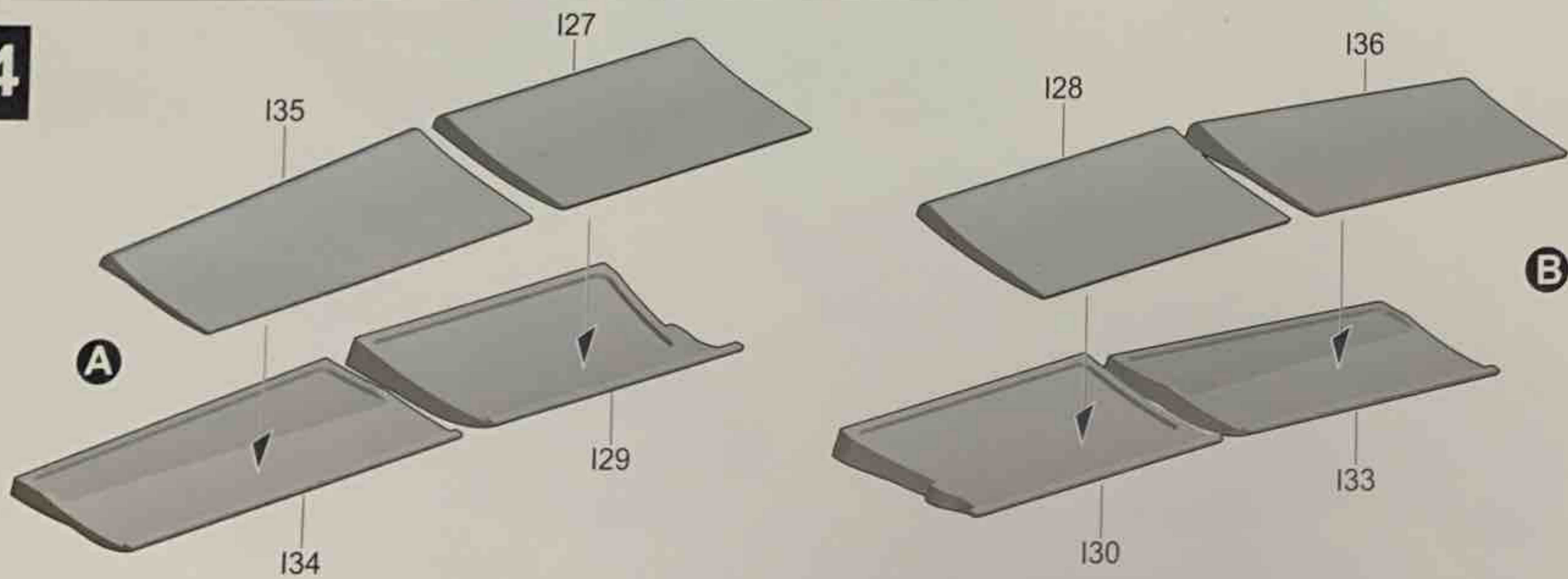

15

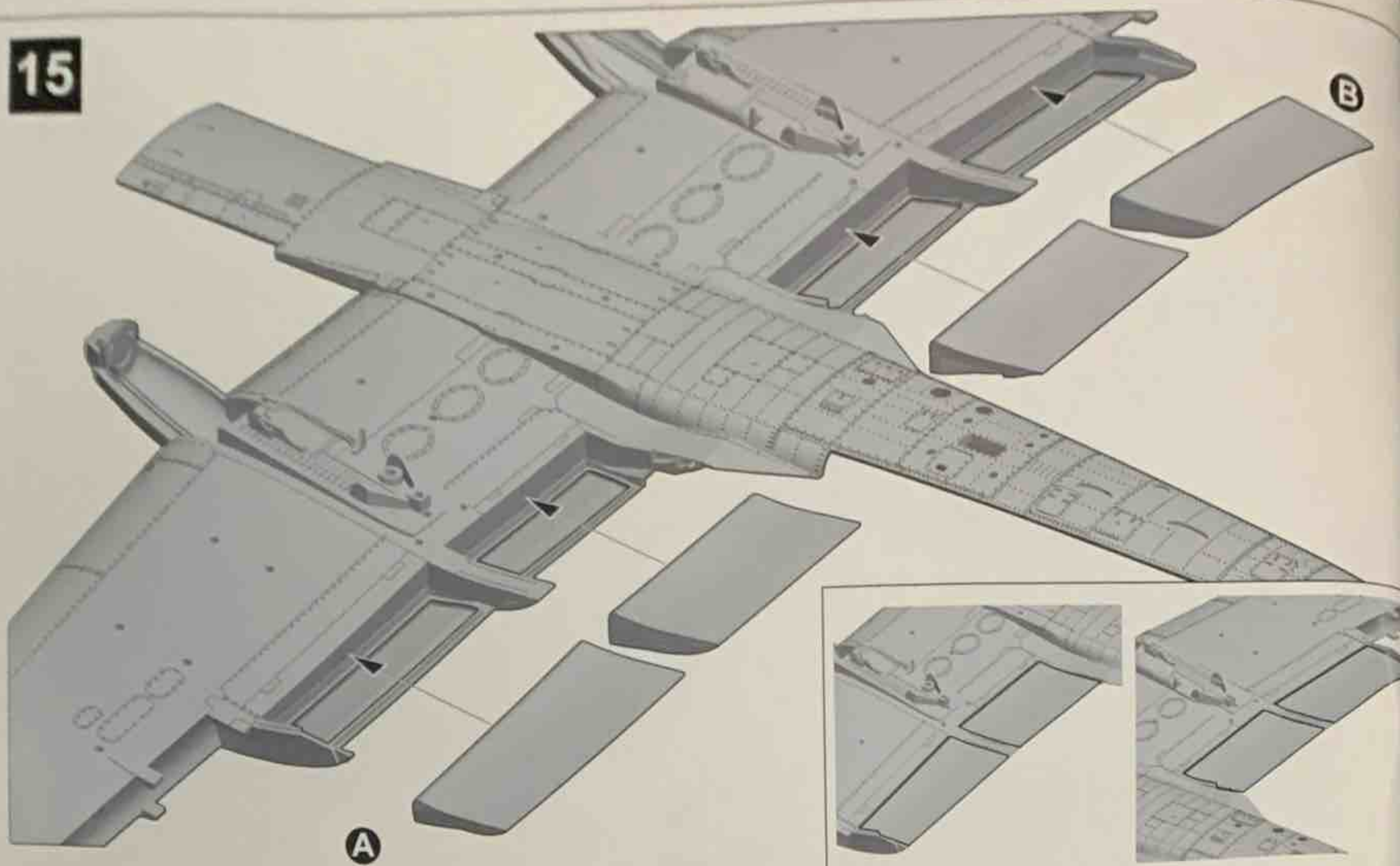

16

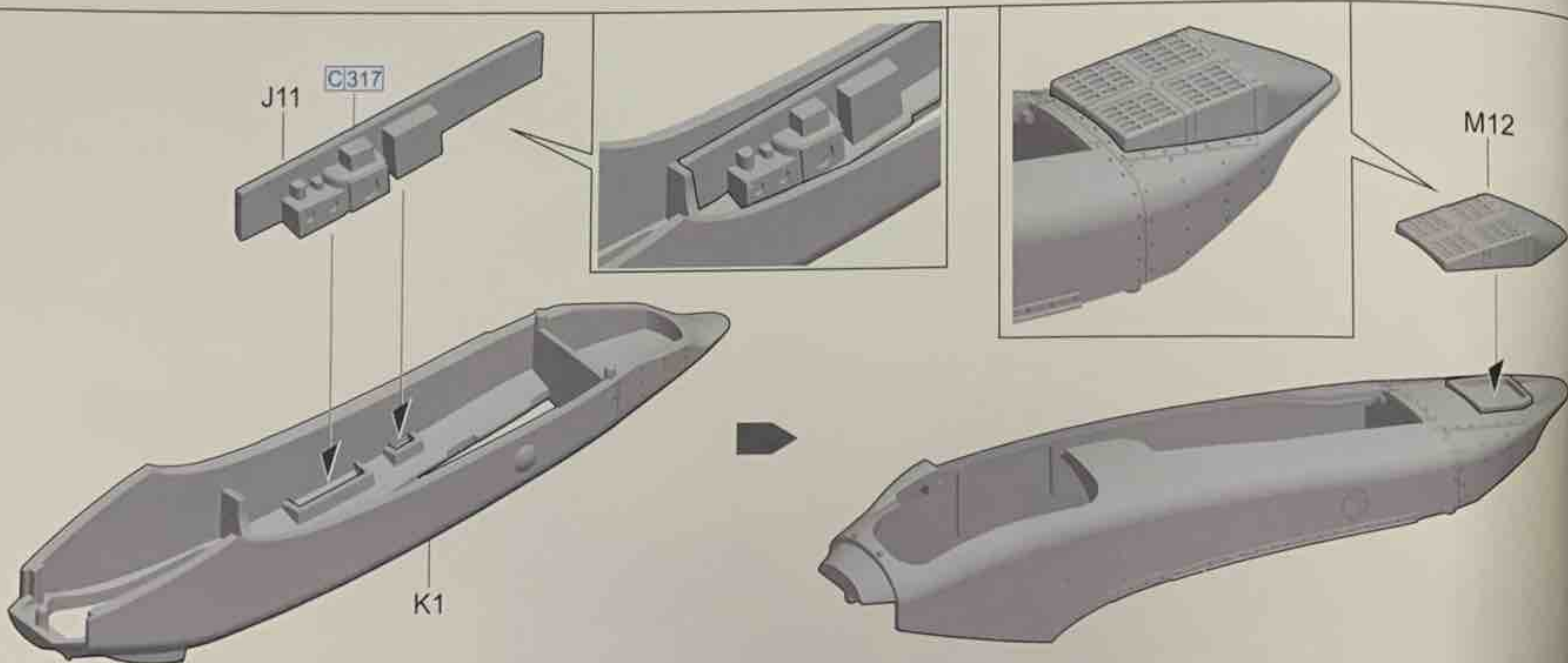
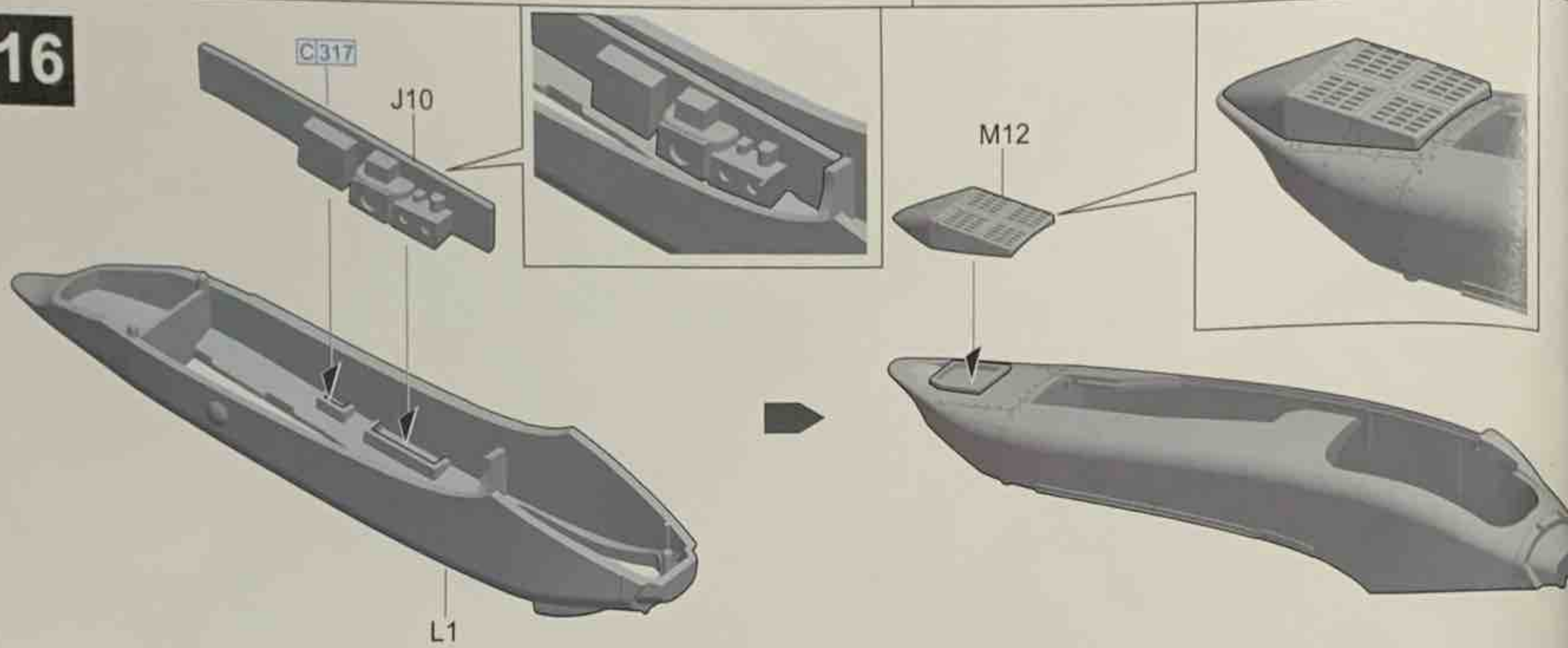

17

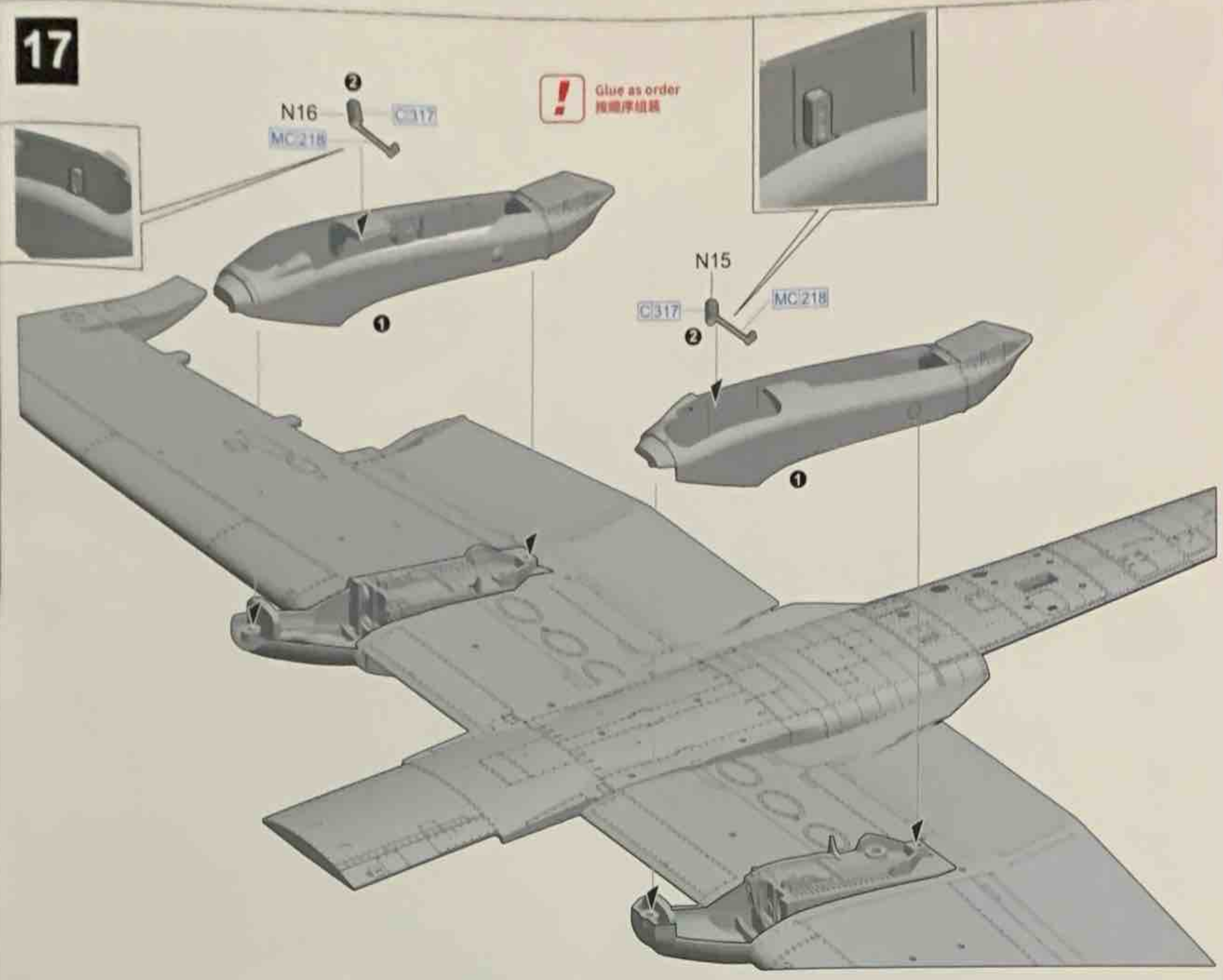

18

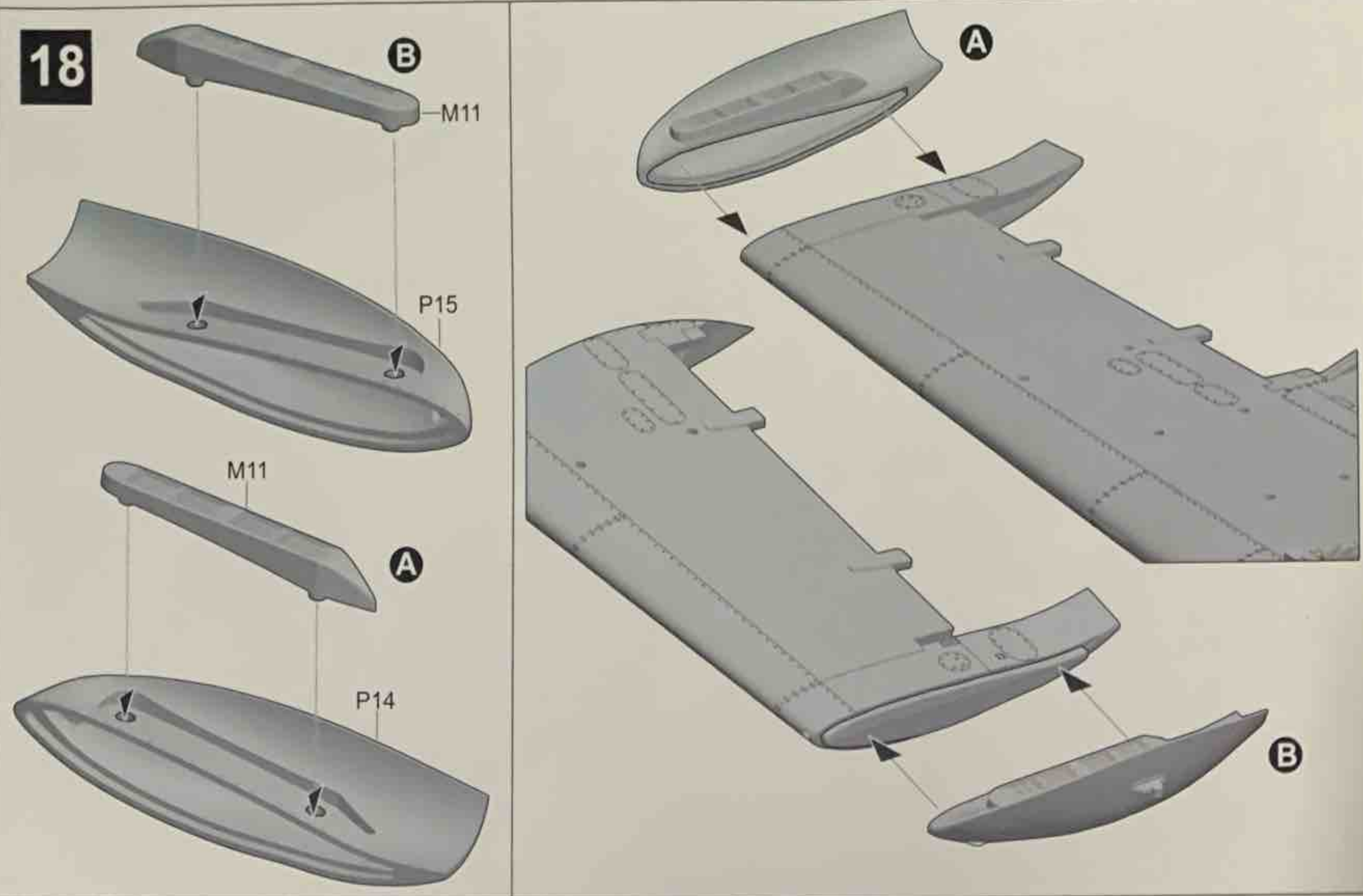

19

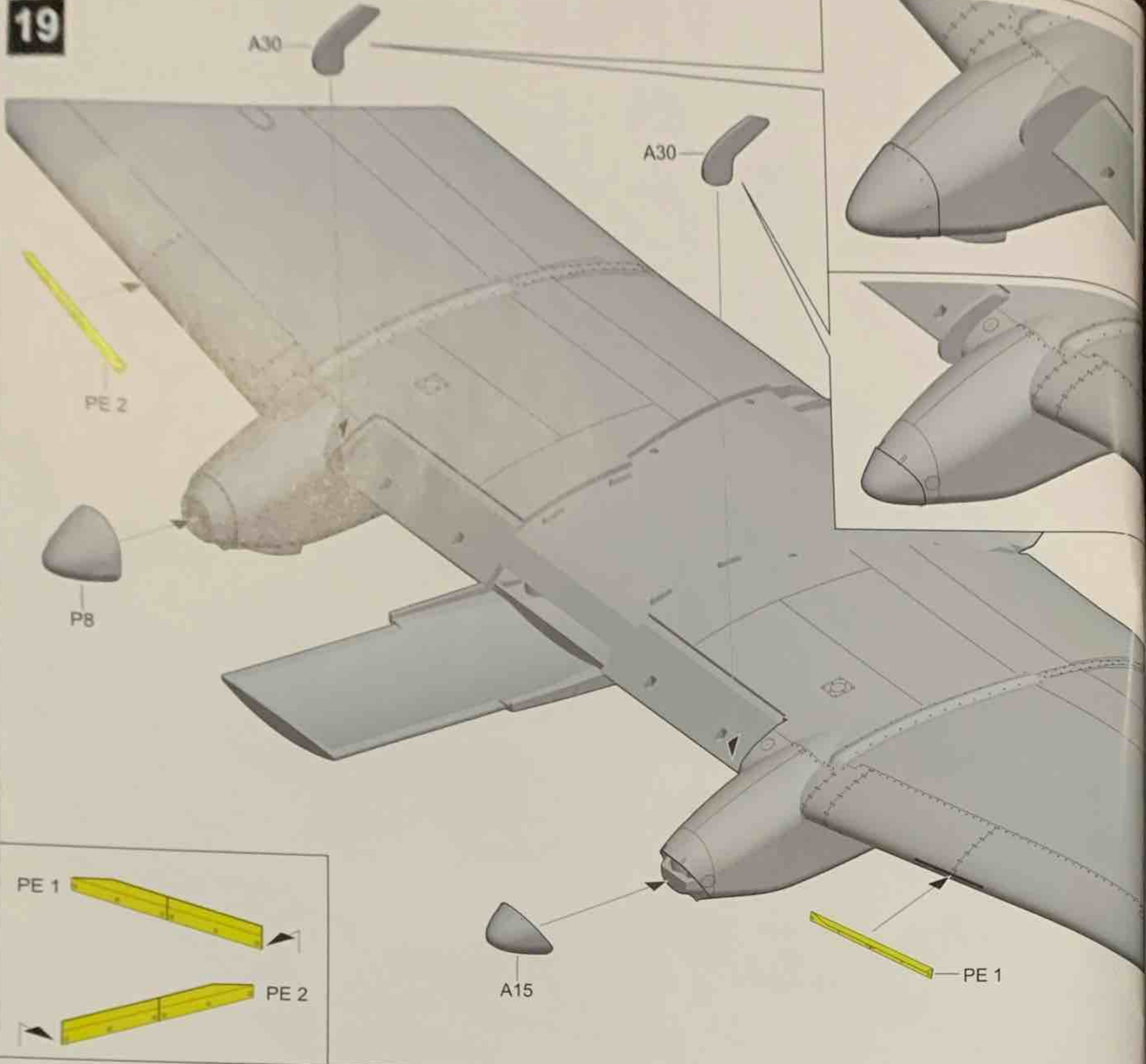

20

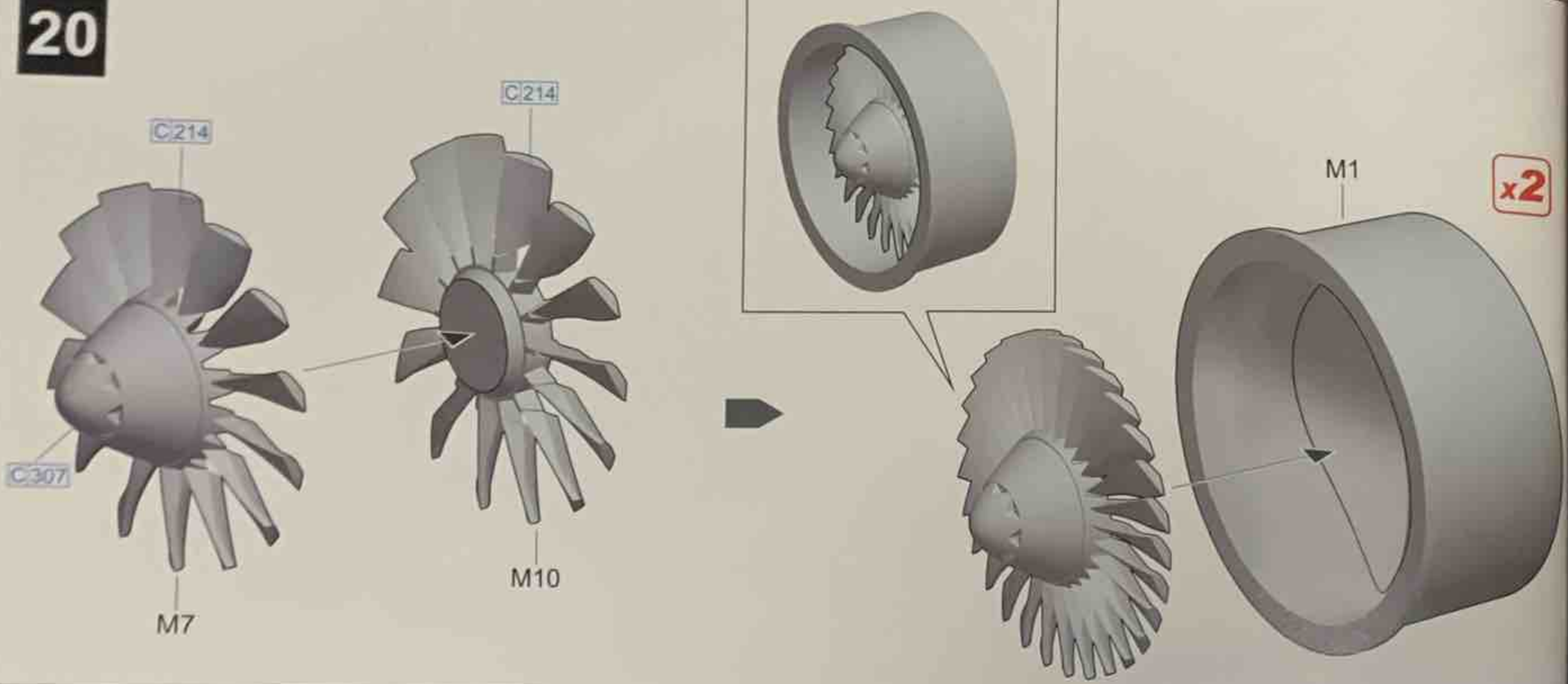

20

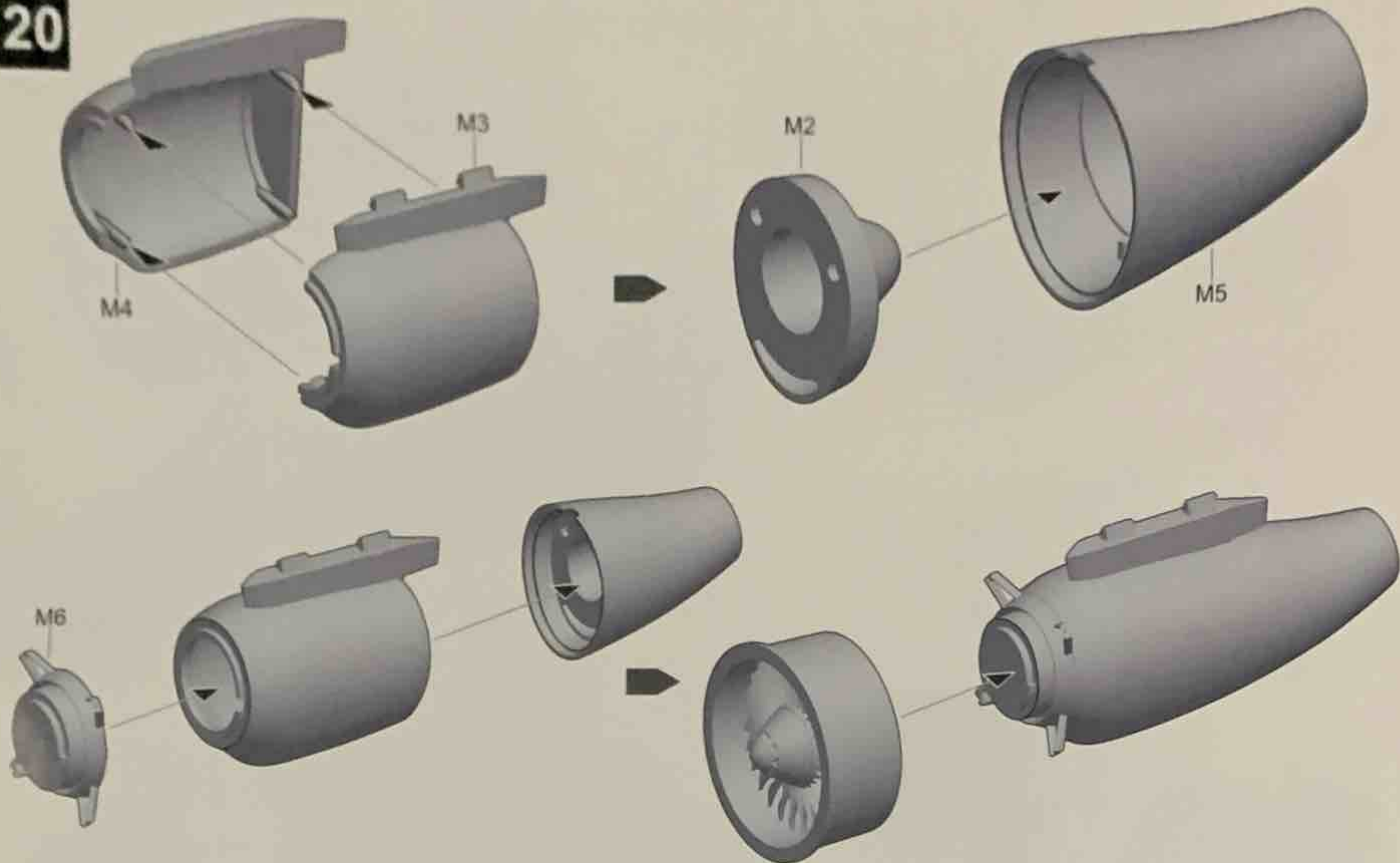

20

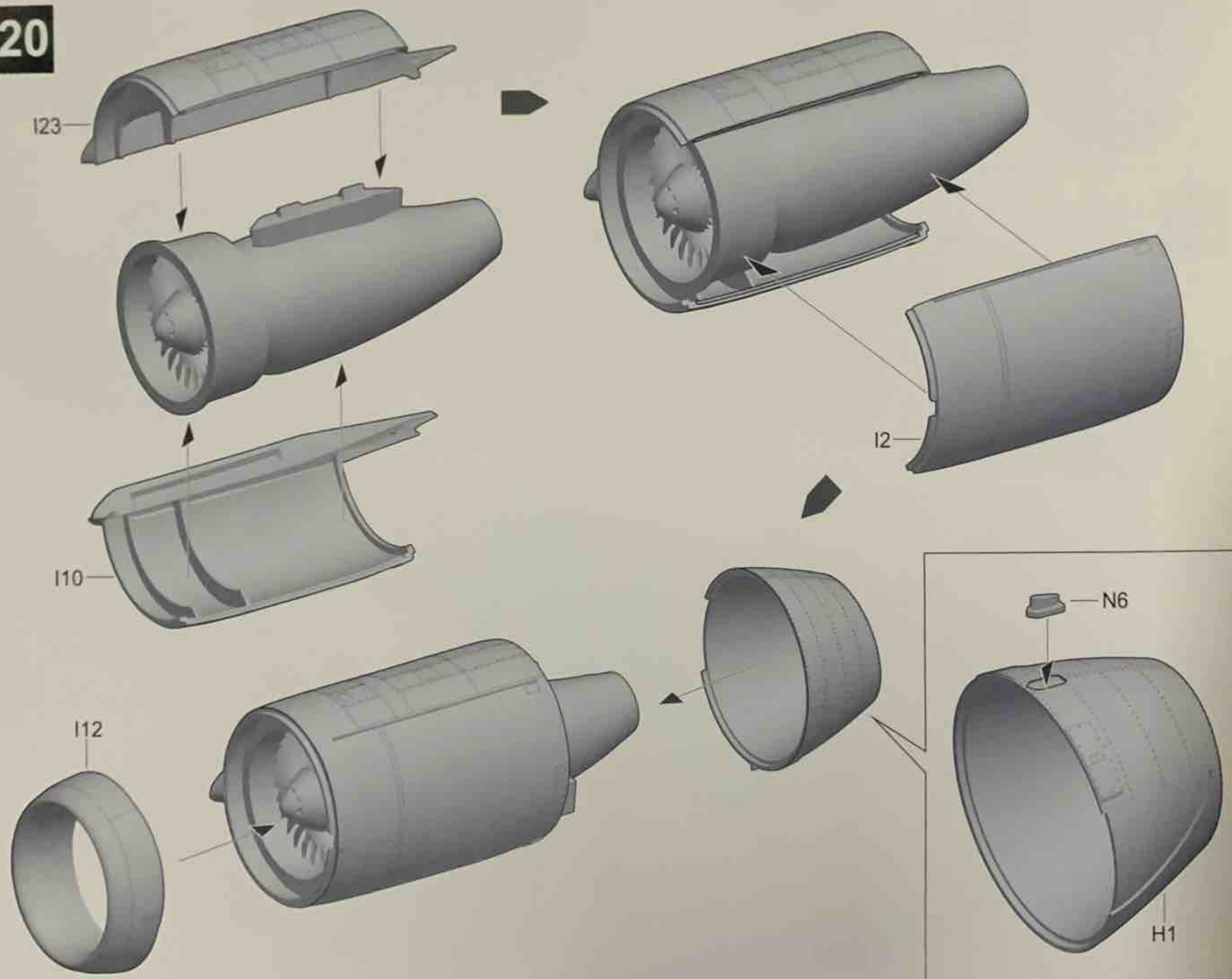

20

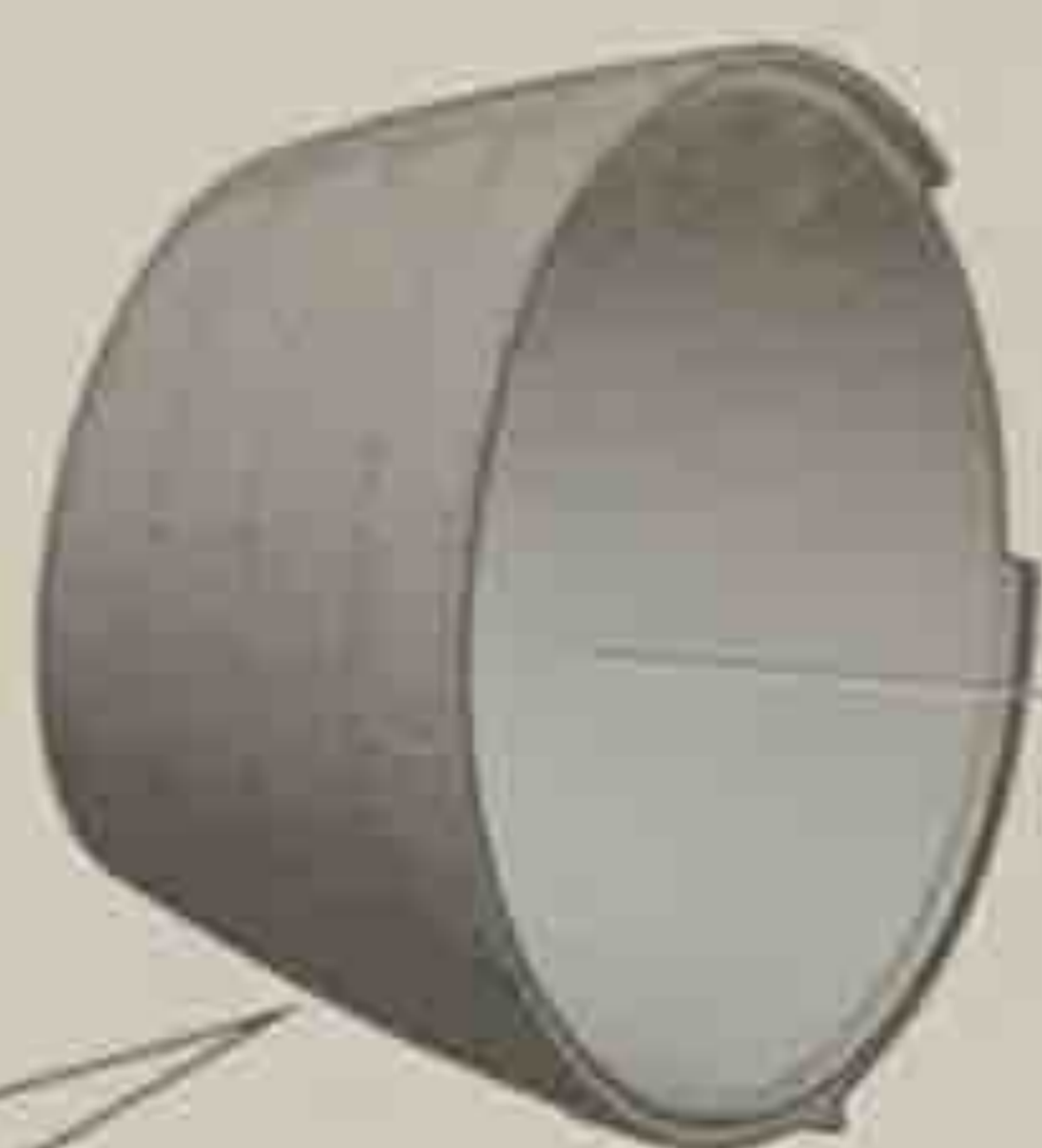
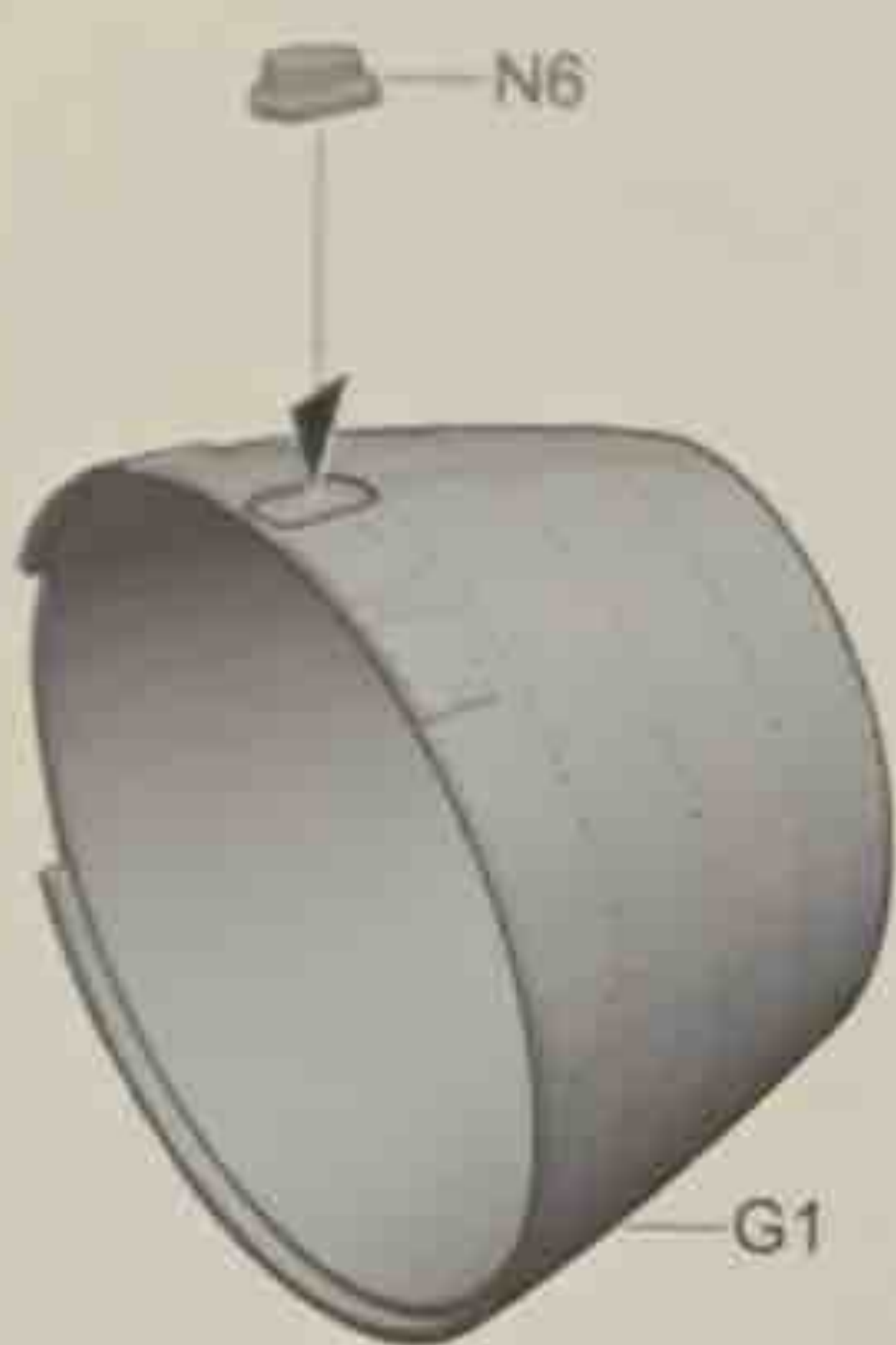
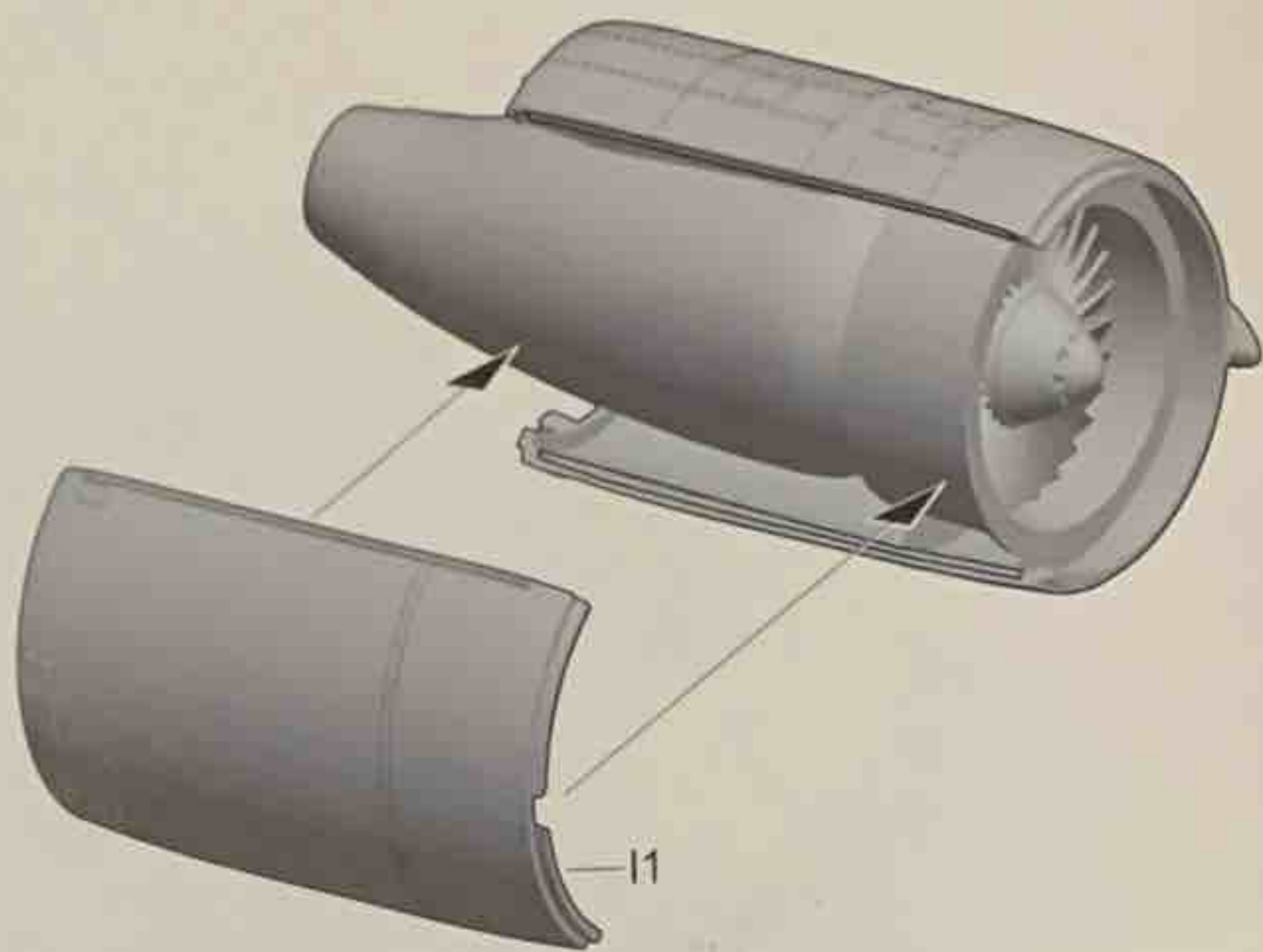

21

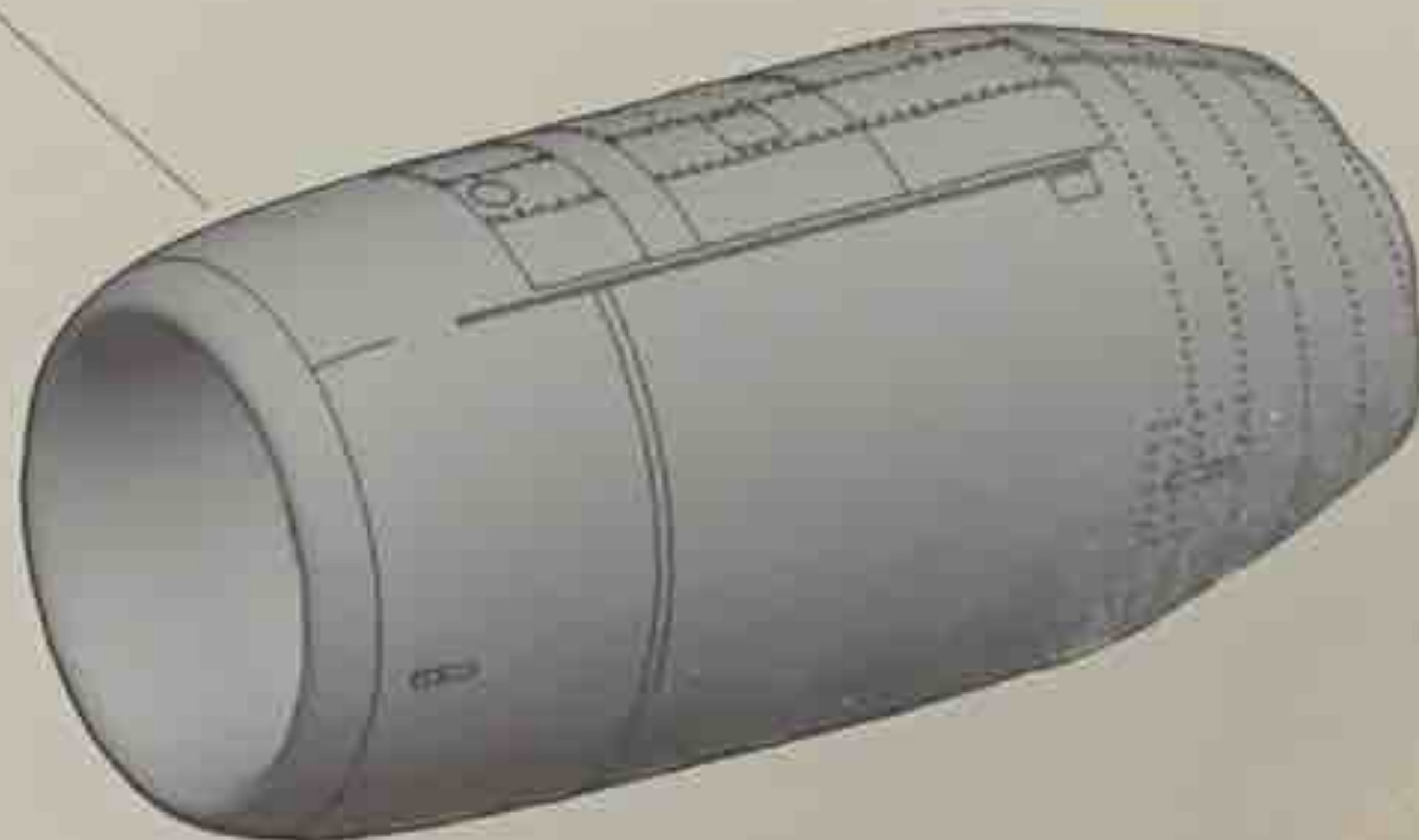
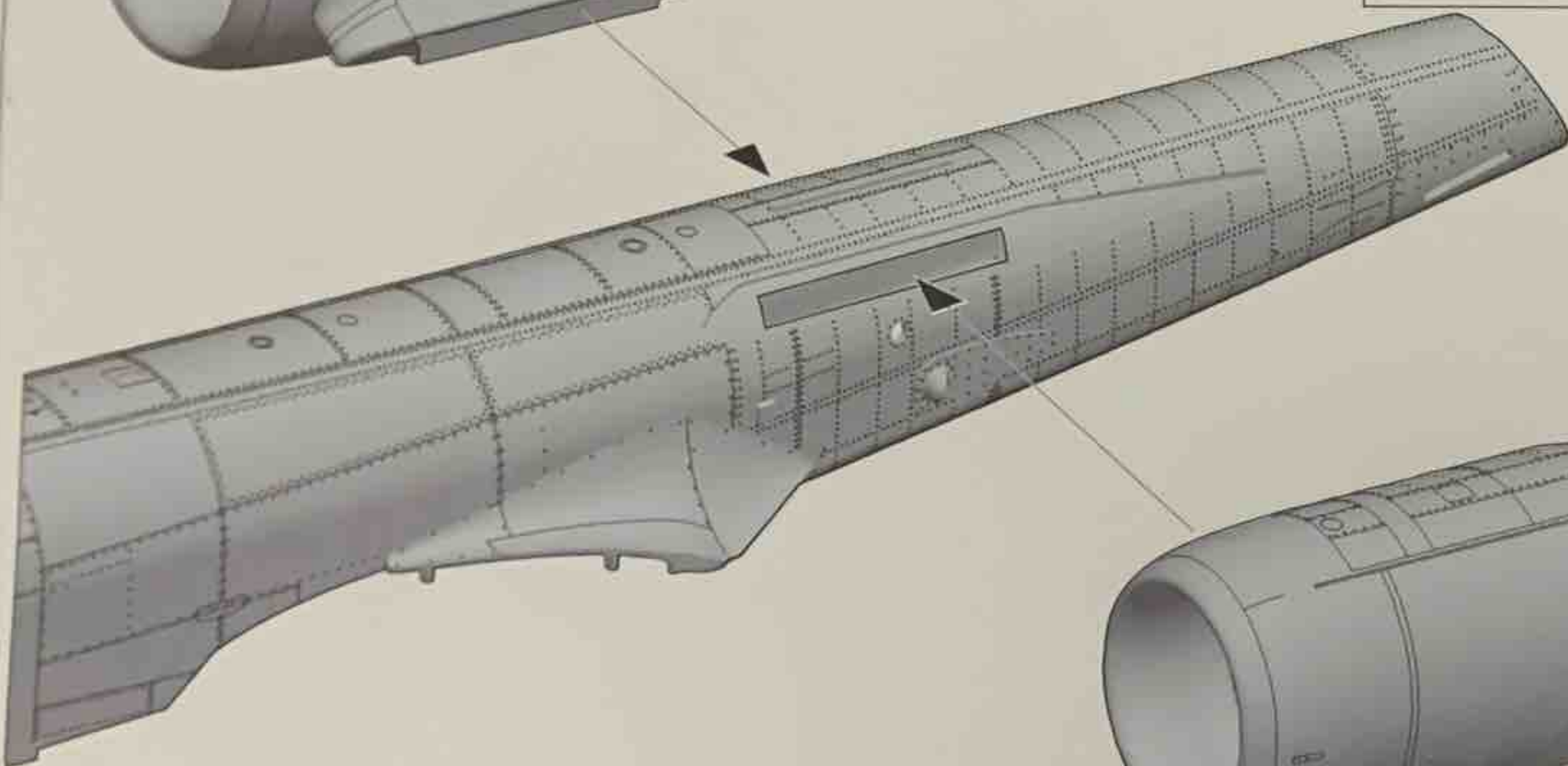
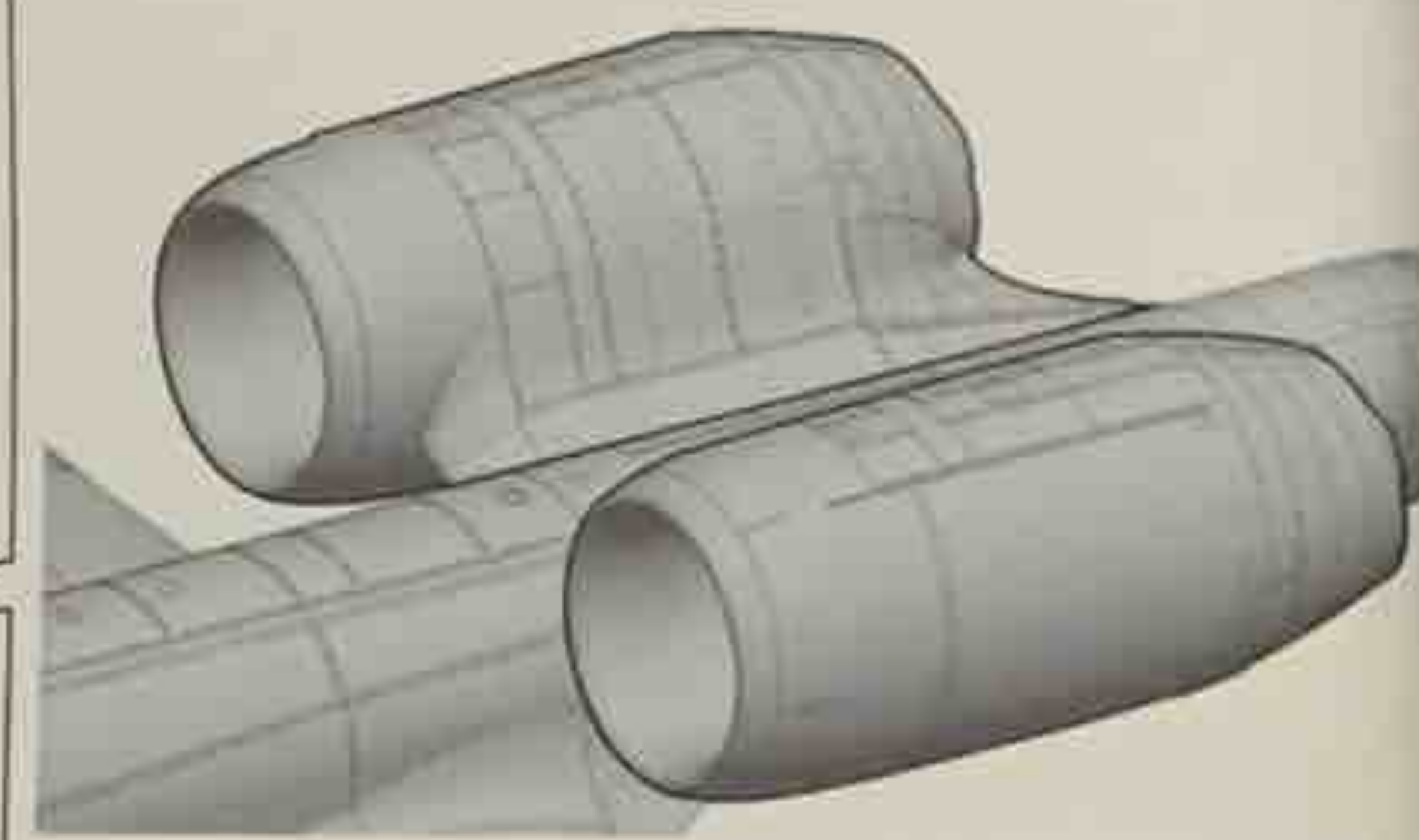
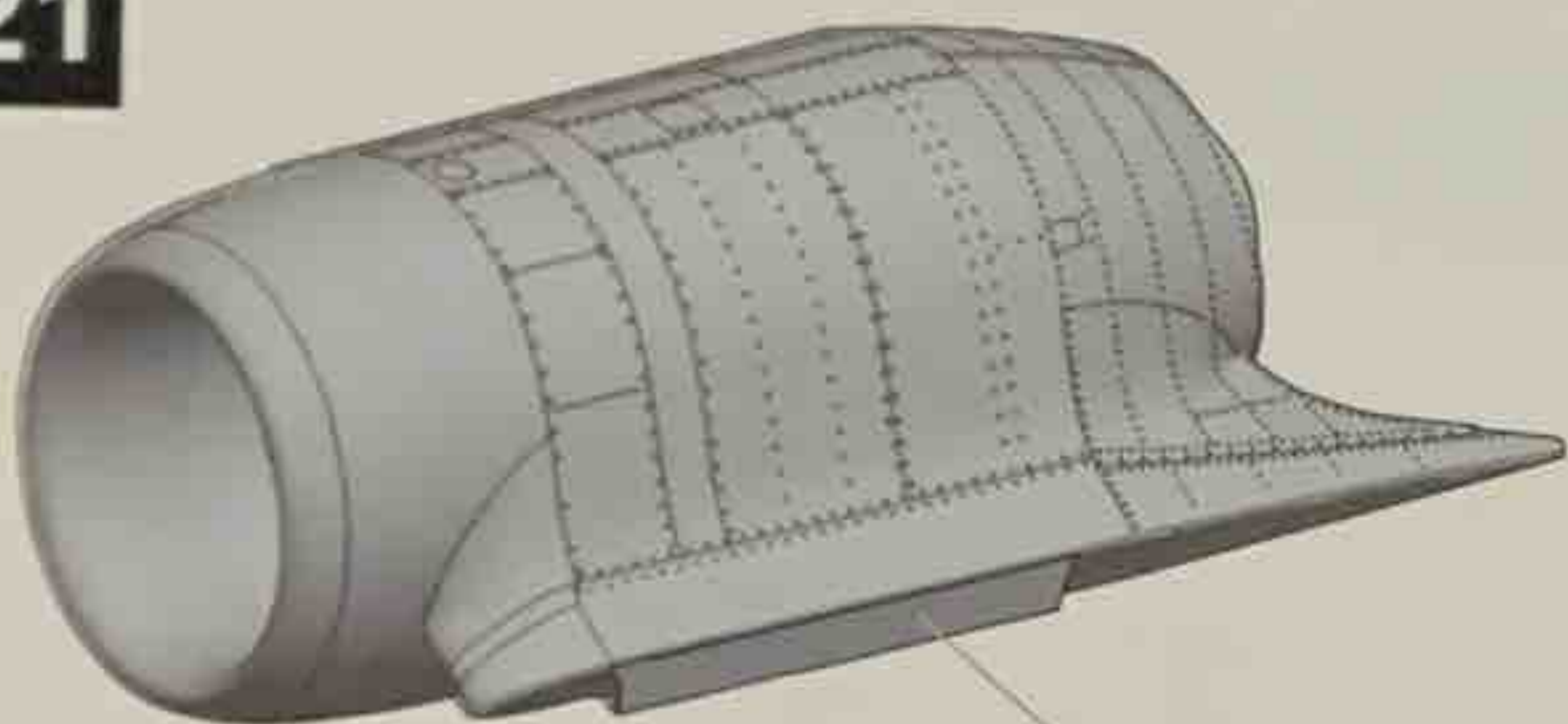

22

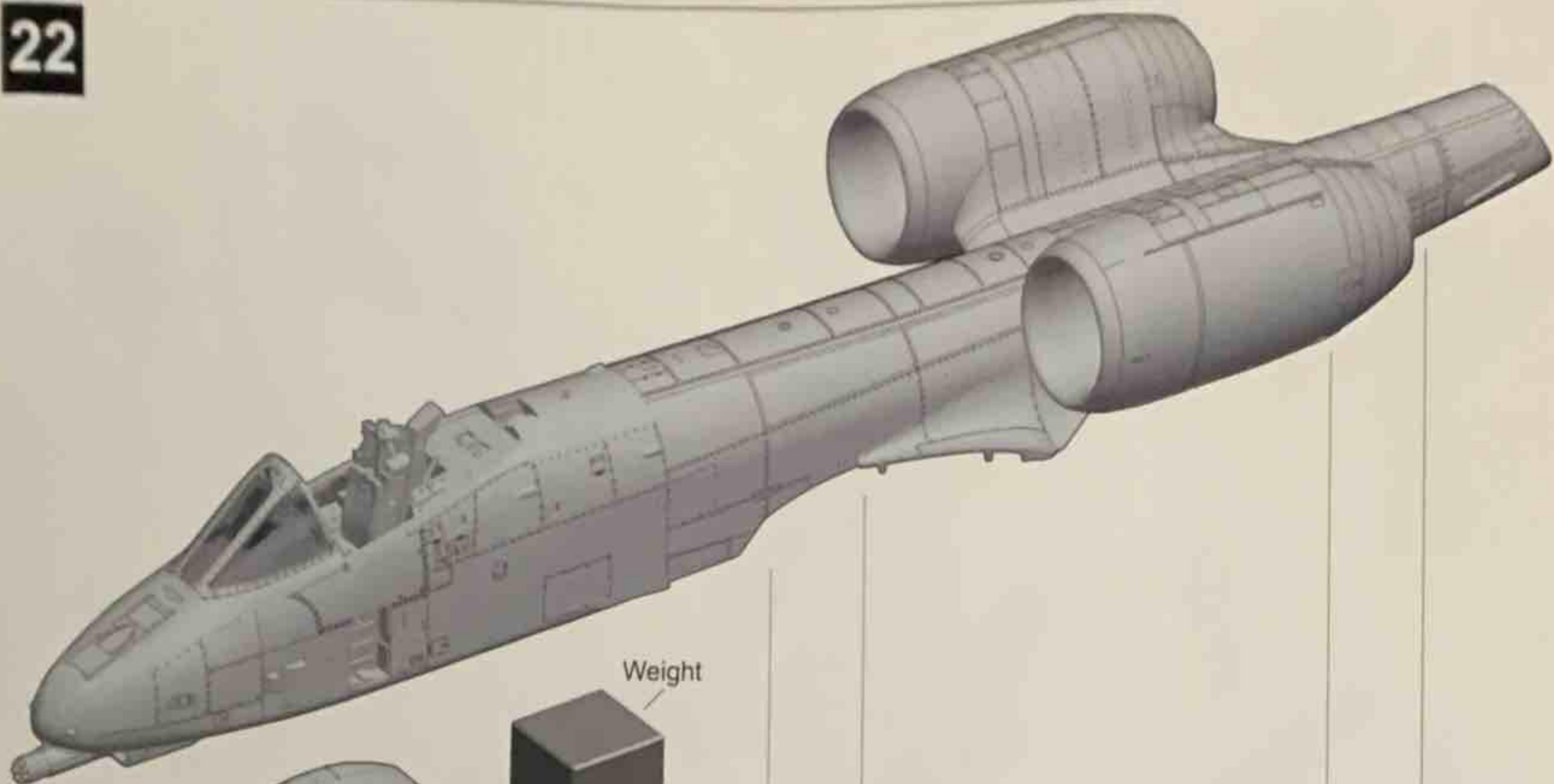

Weight



! Weight
 Size 18*18*24mm
 weight 61g

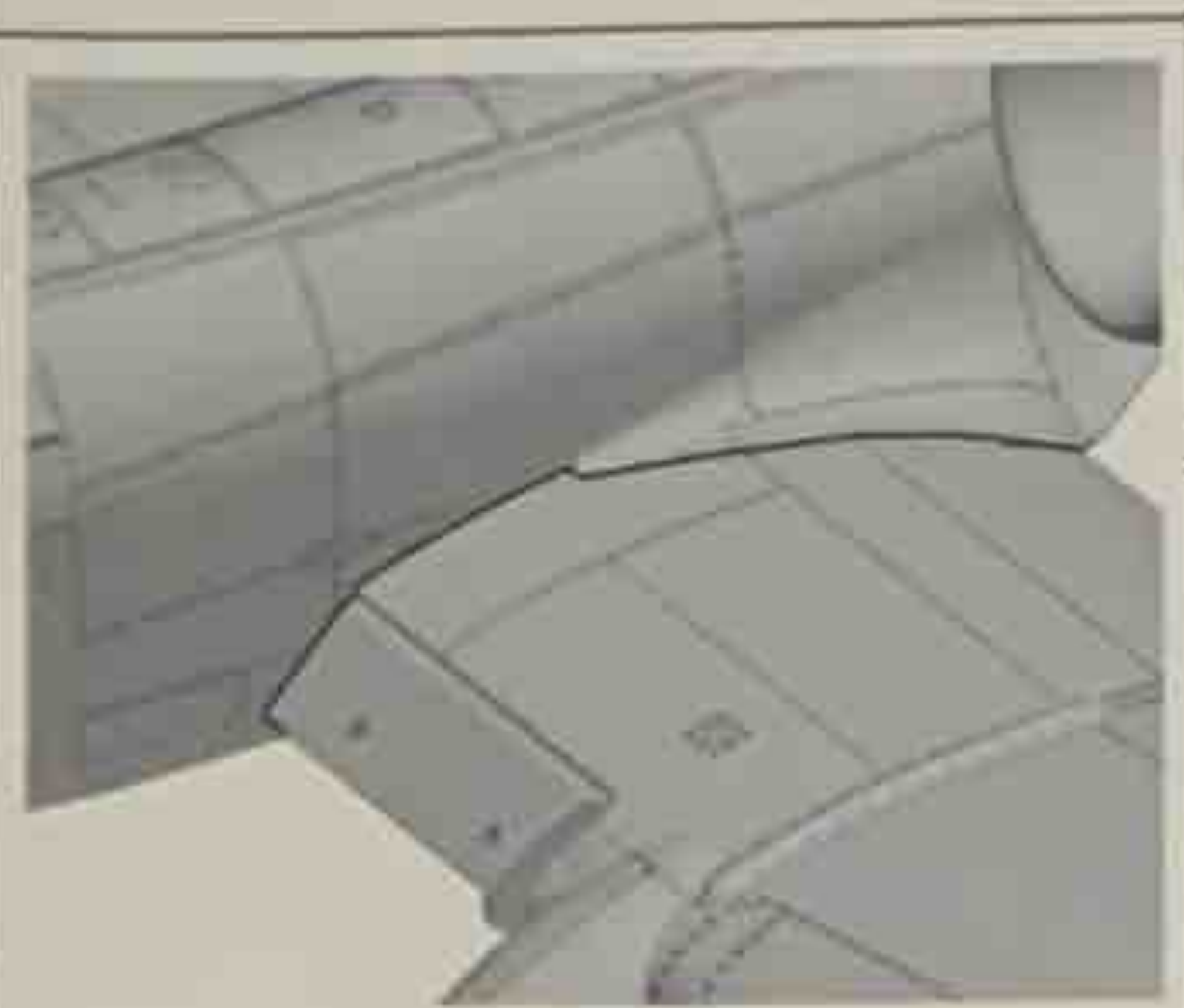
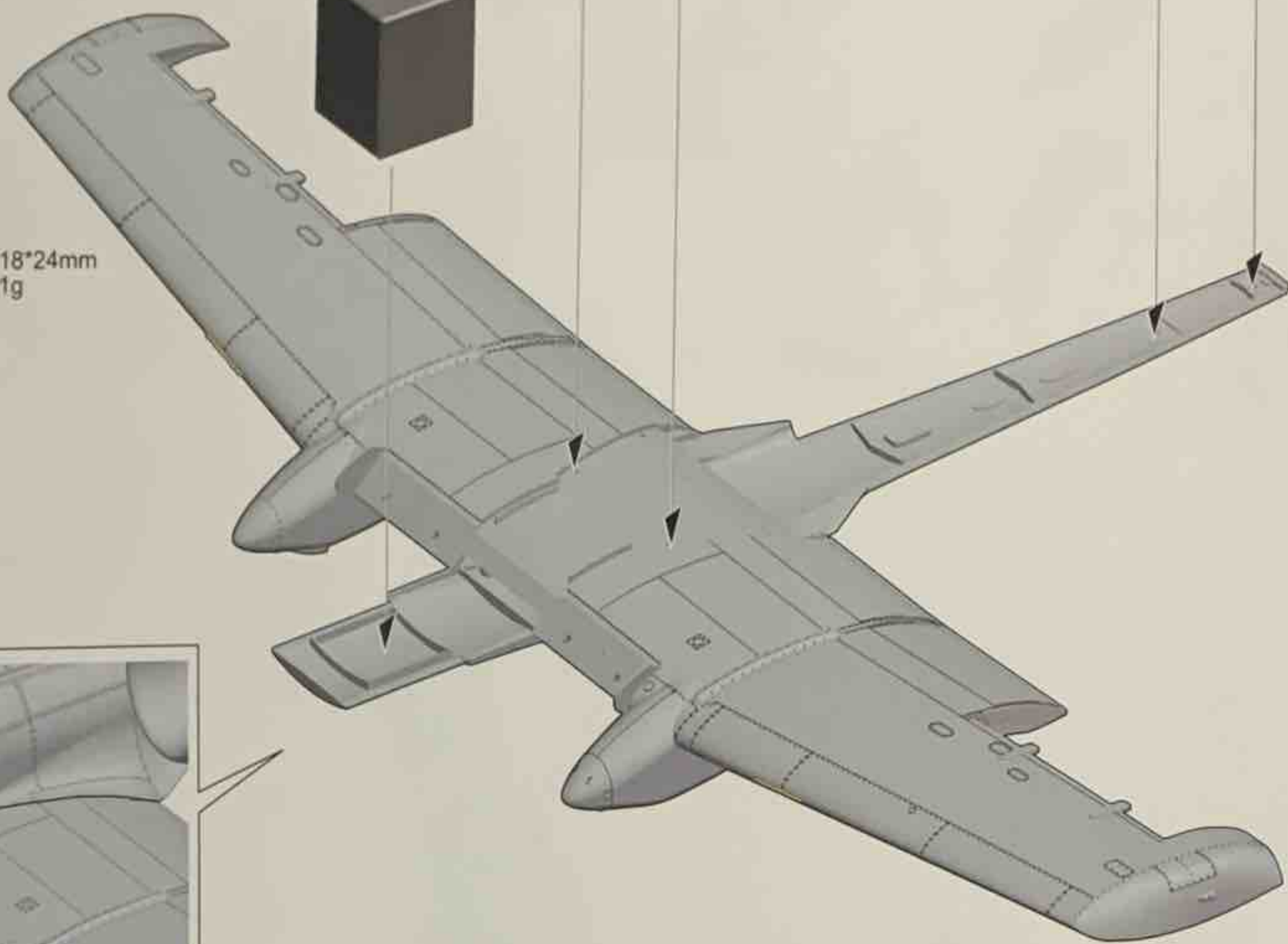

23

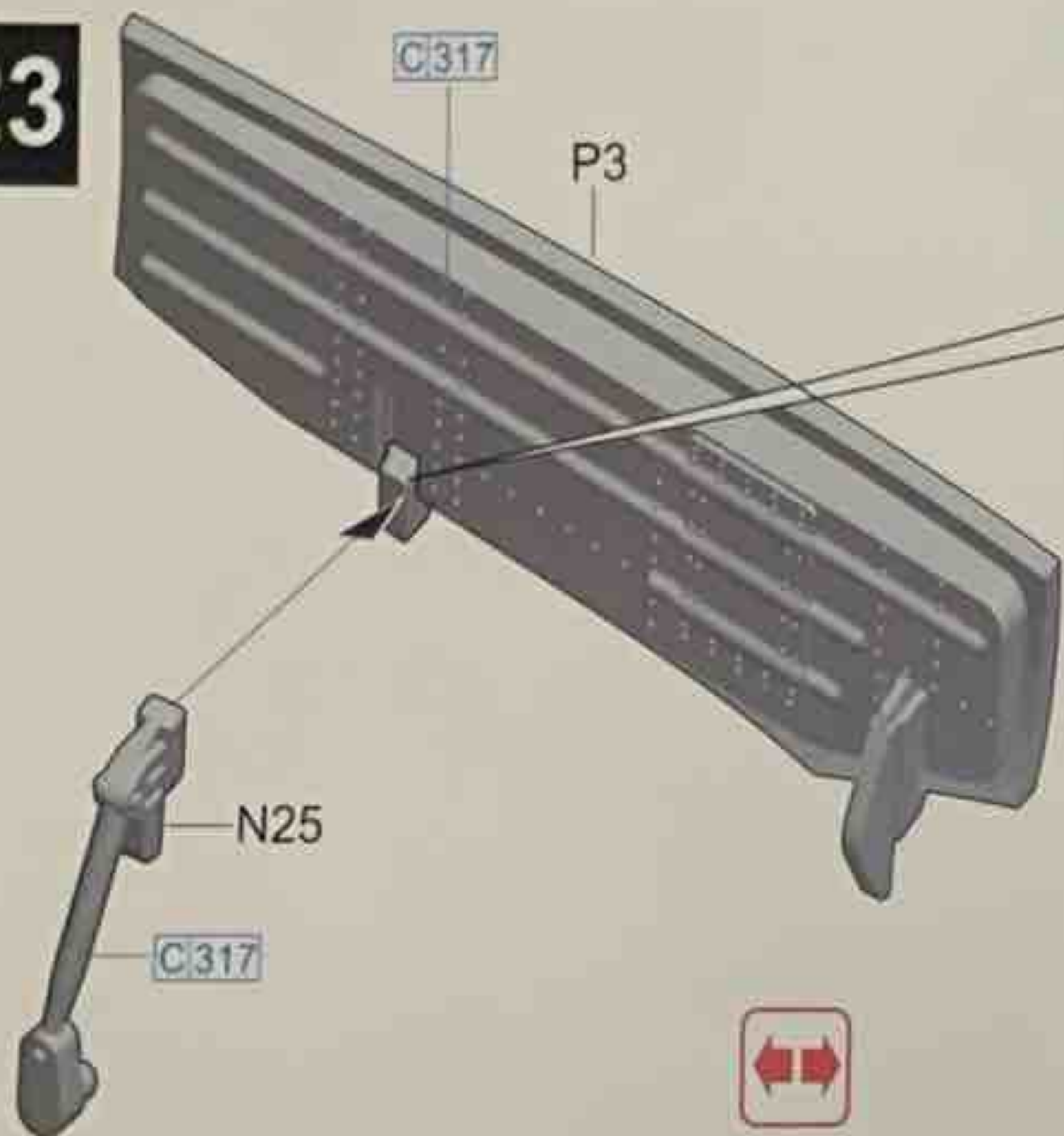

C317

P3

N25

C317

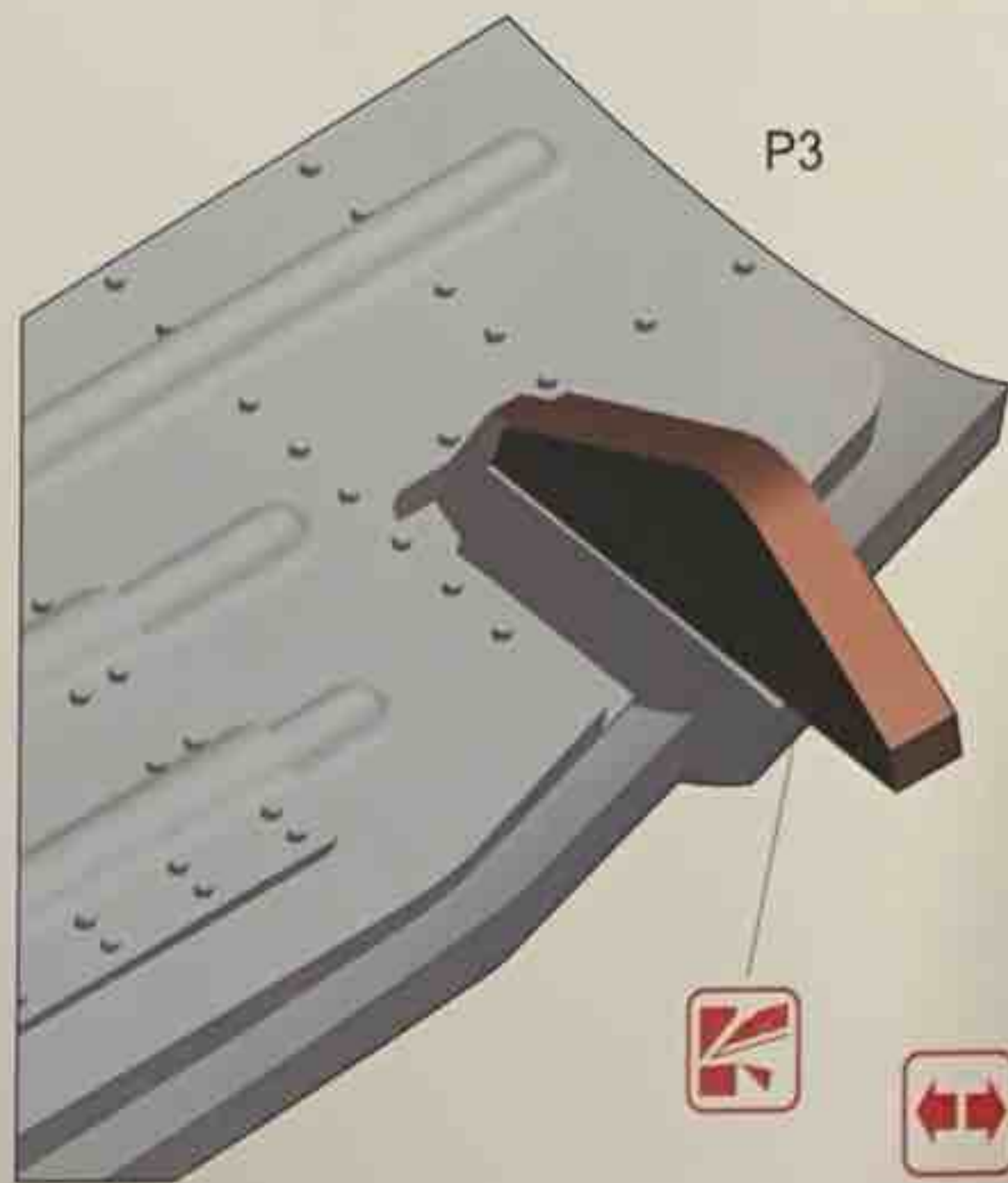
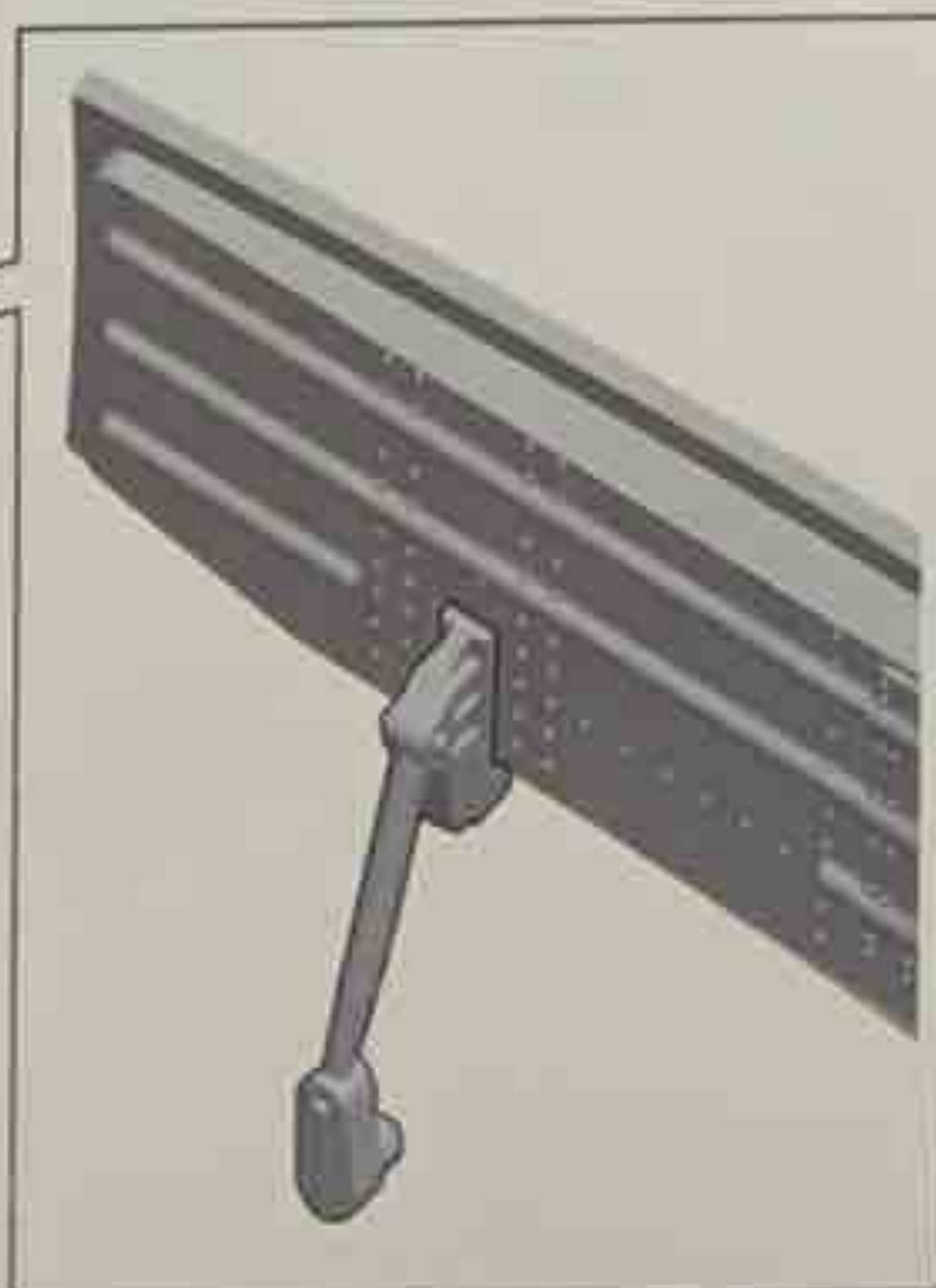

P3



24

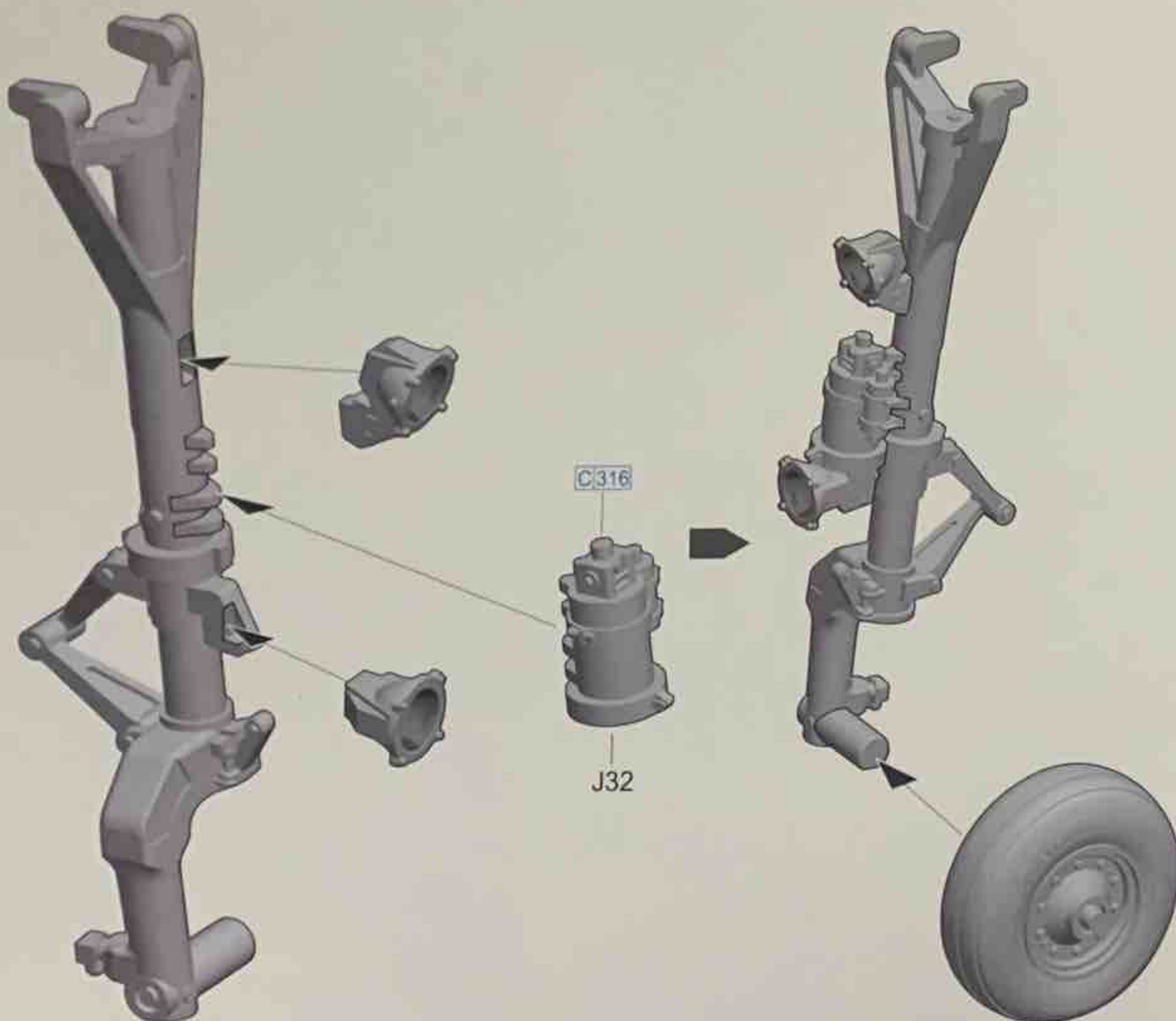
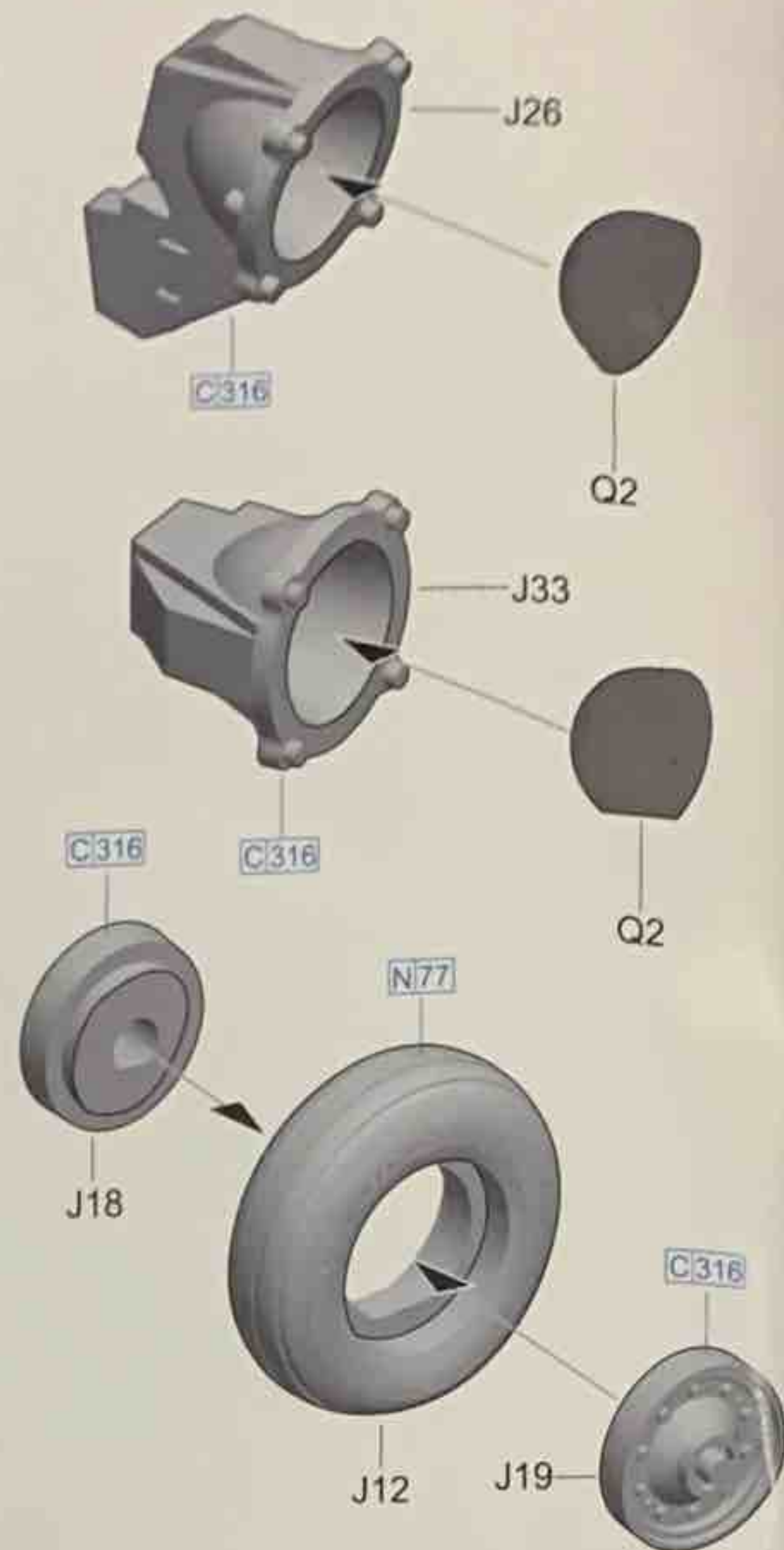
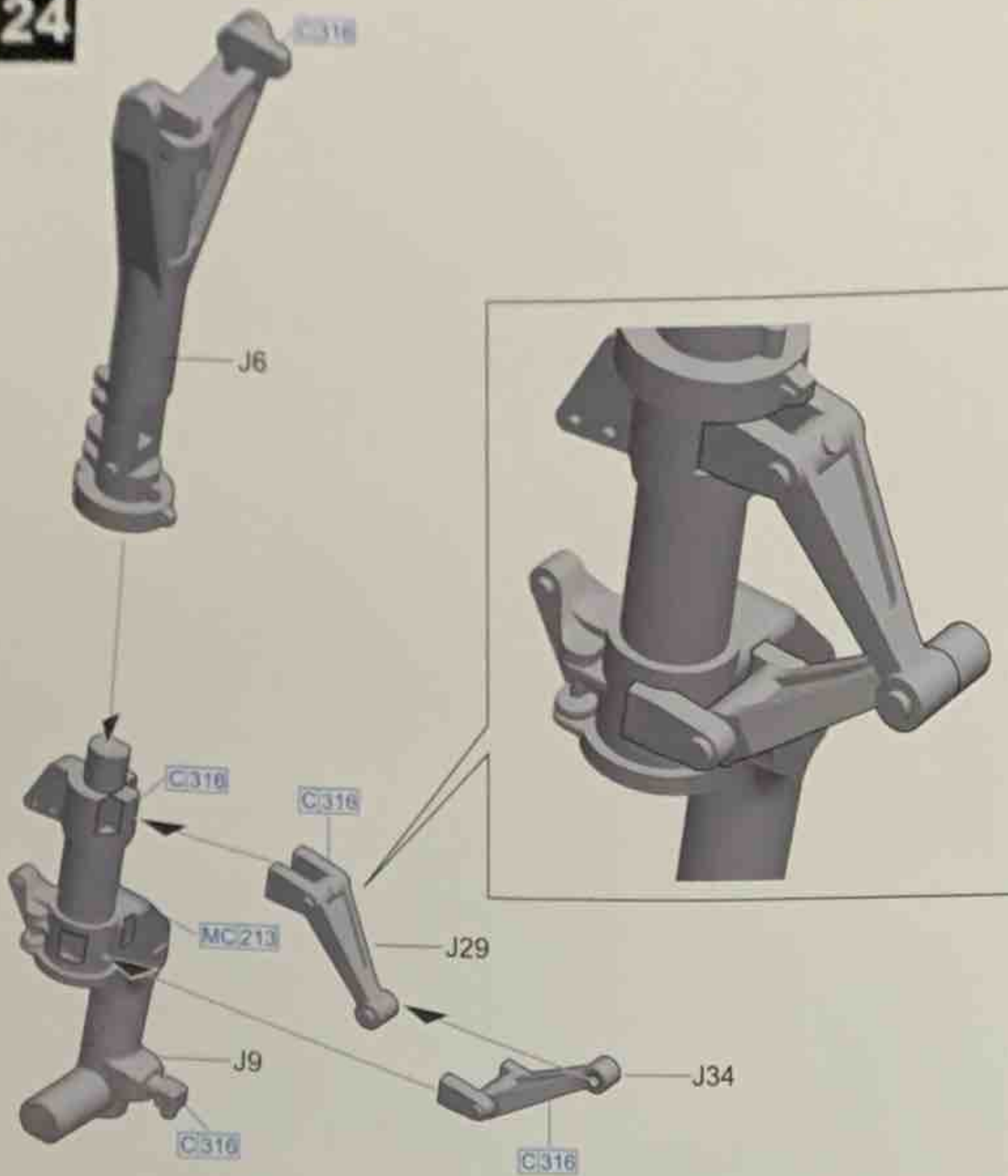

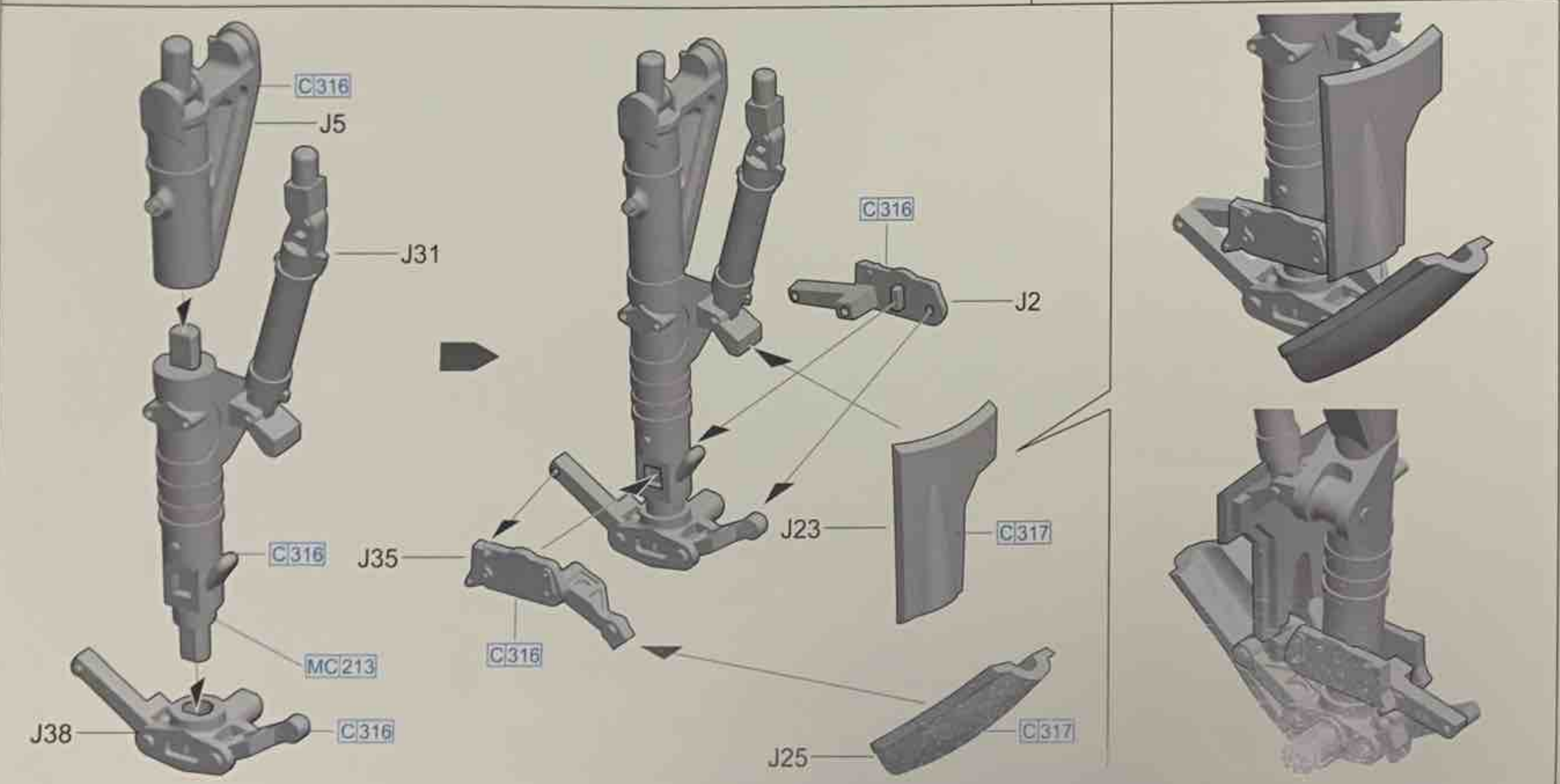
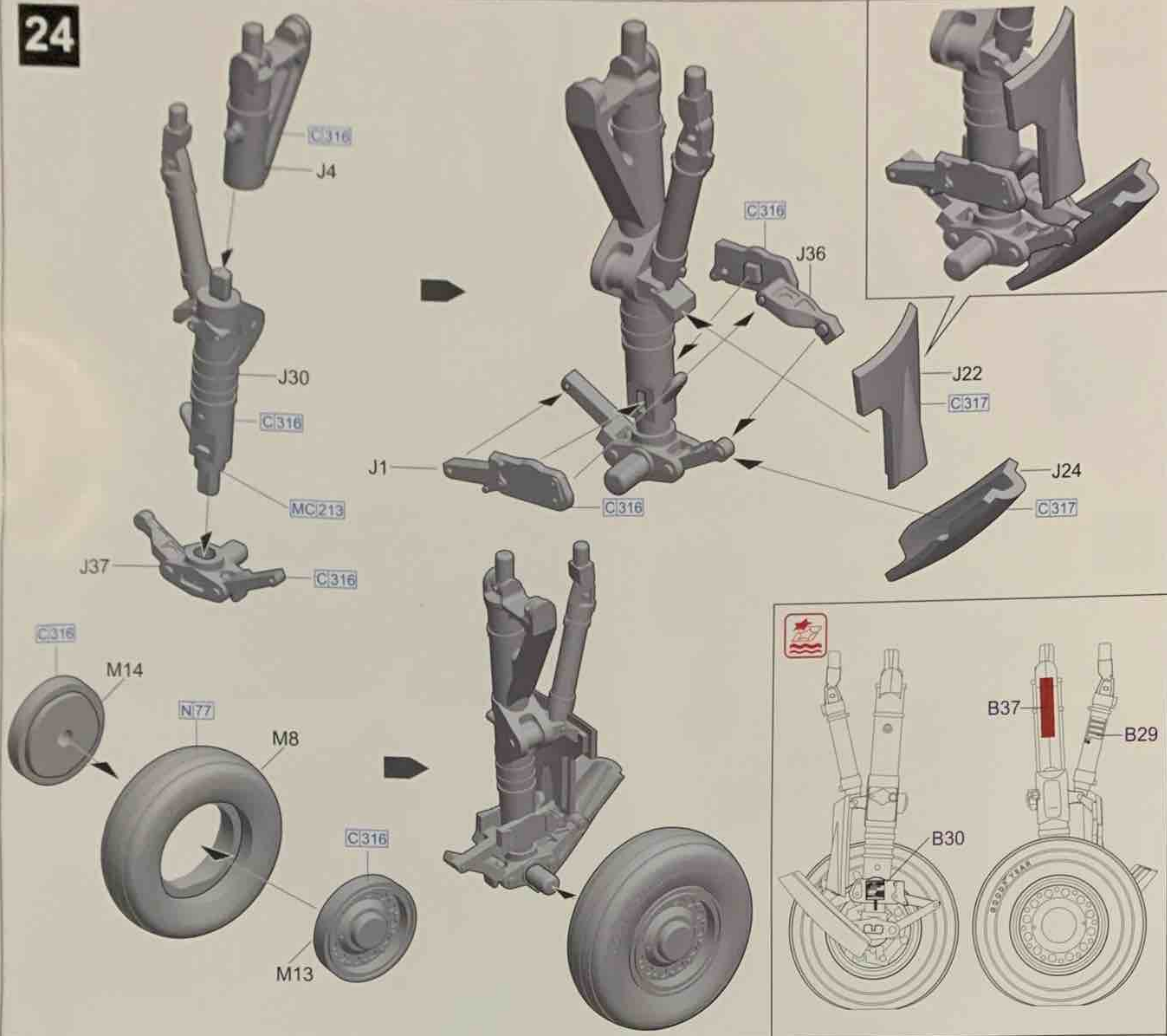

24

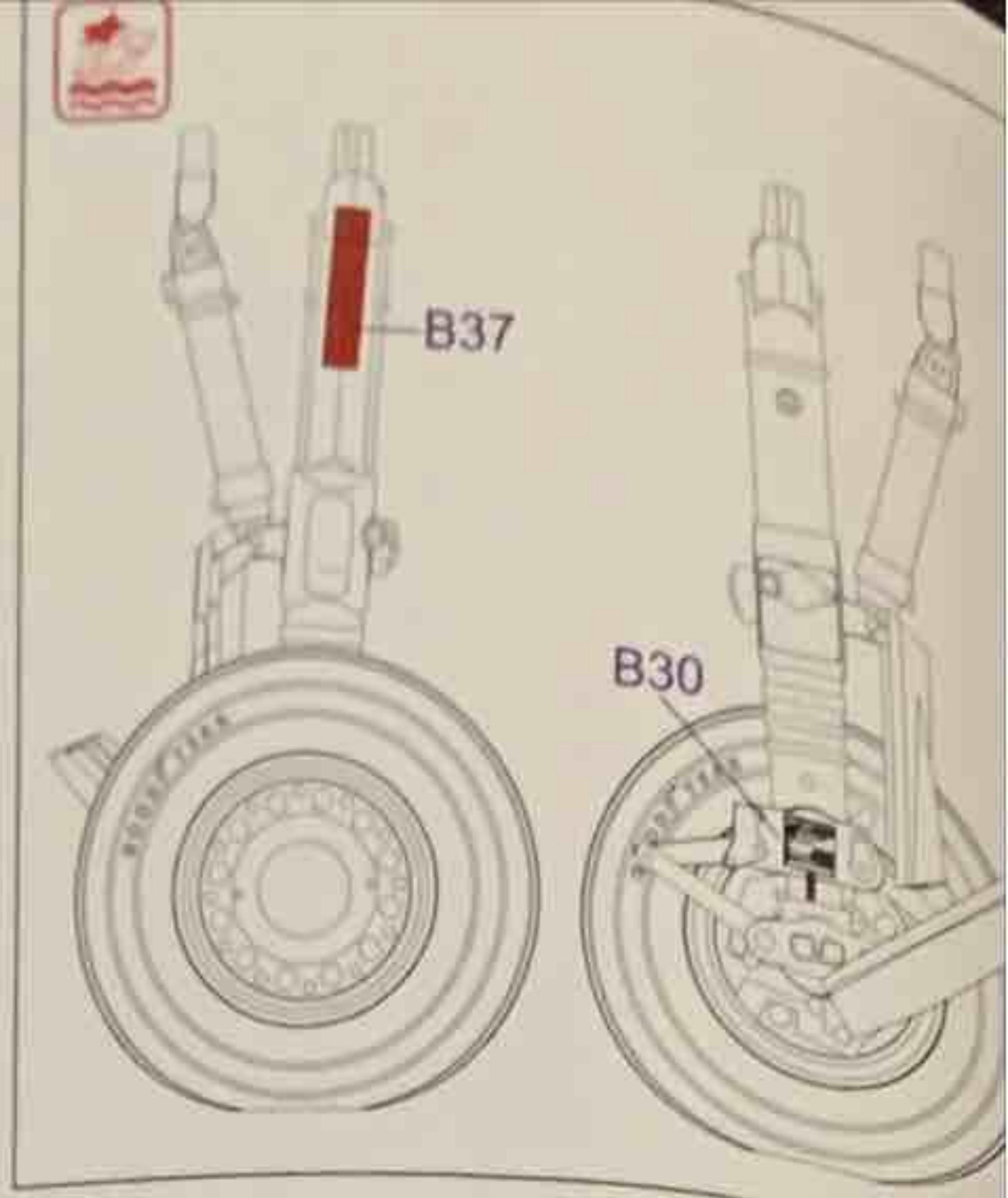
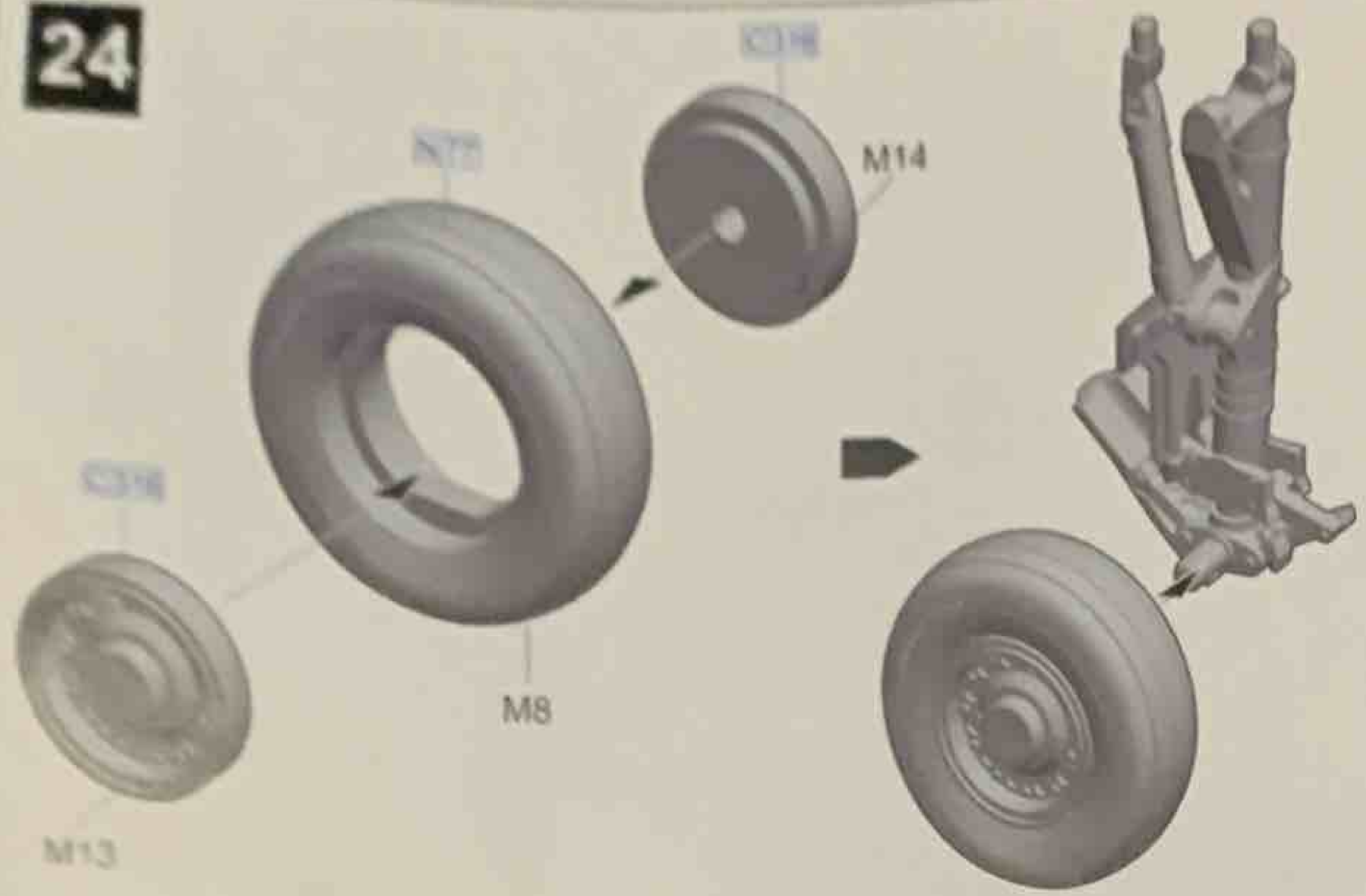

25



Canopy opened
舱盖打开

26

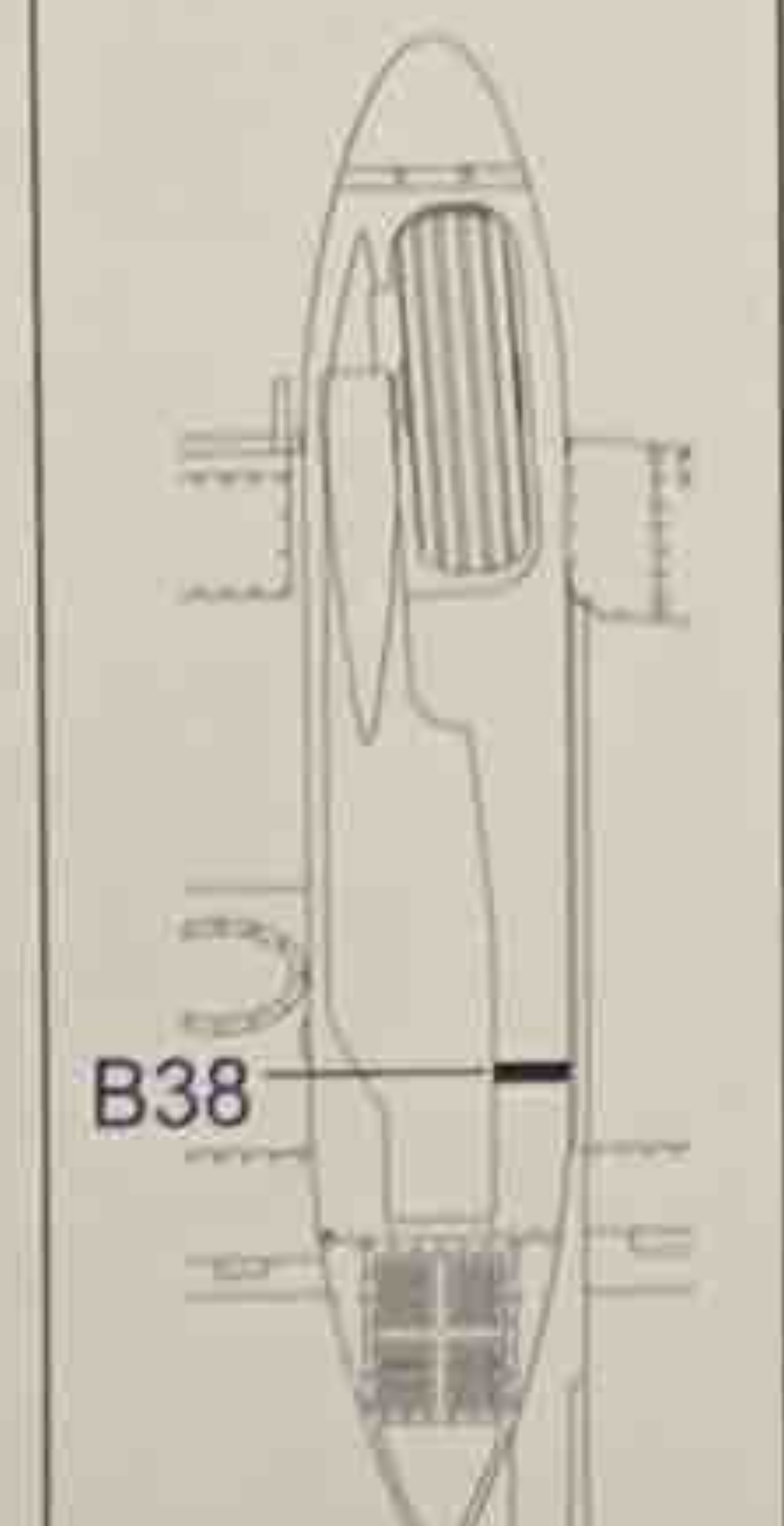
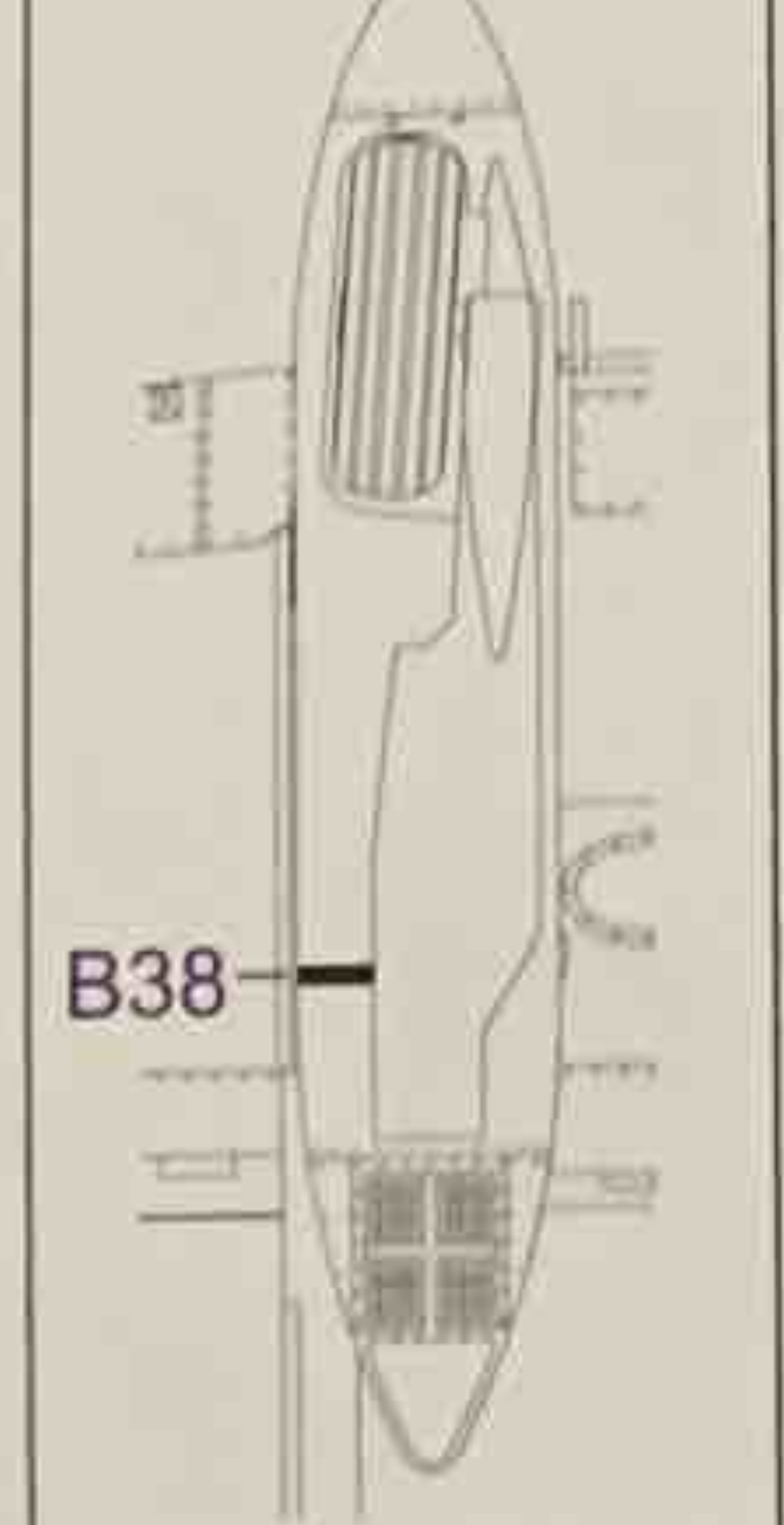
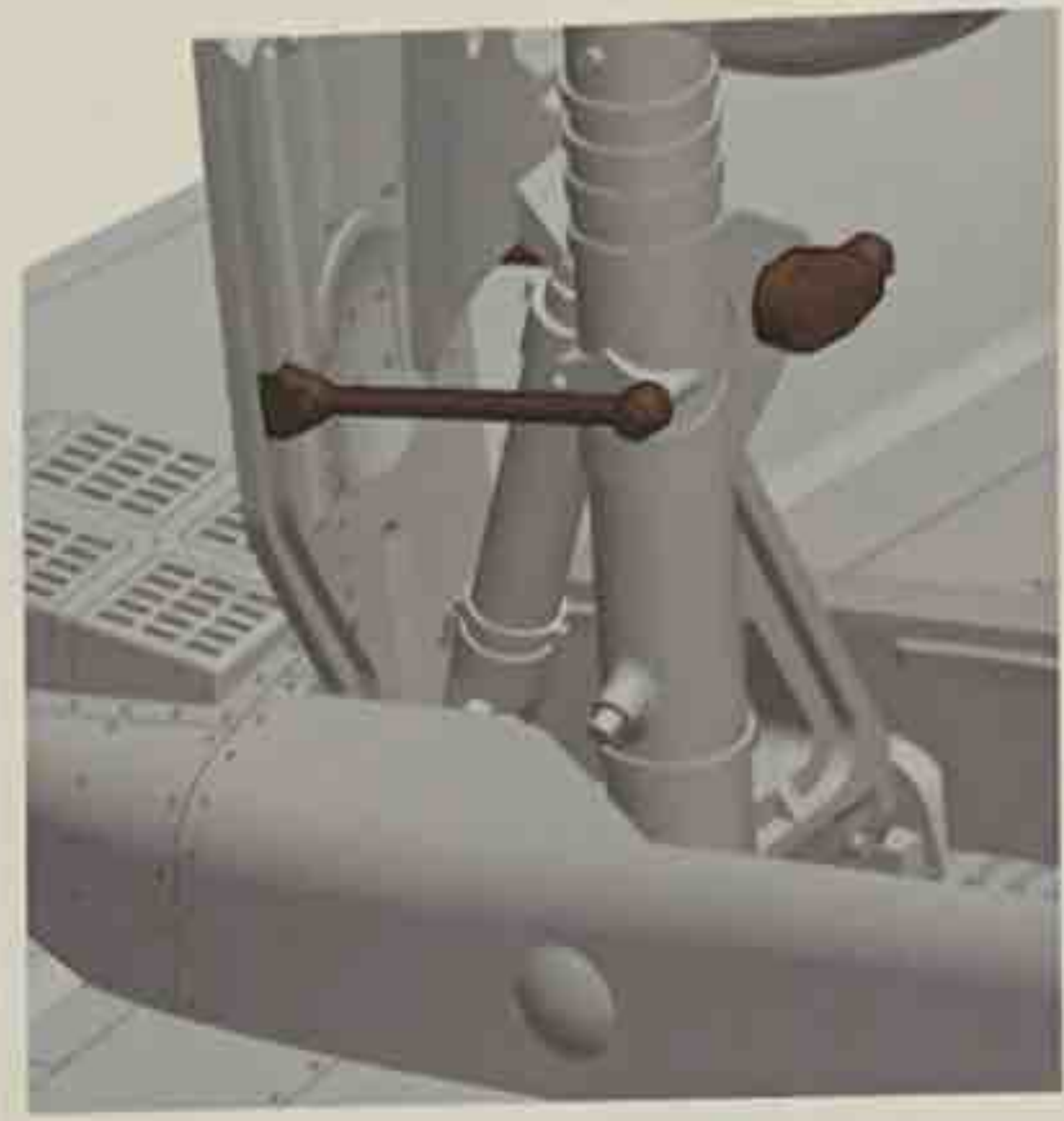
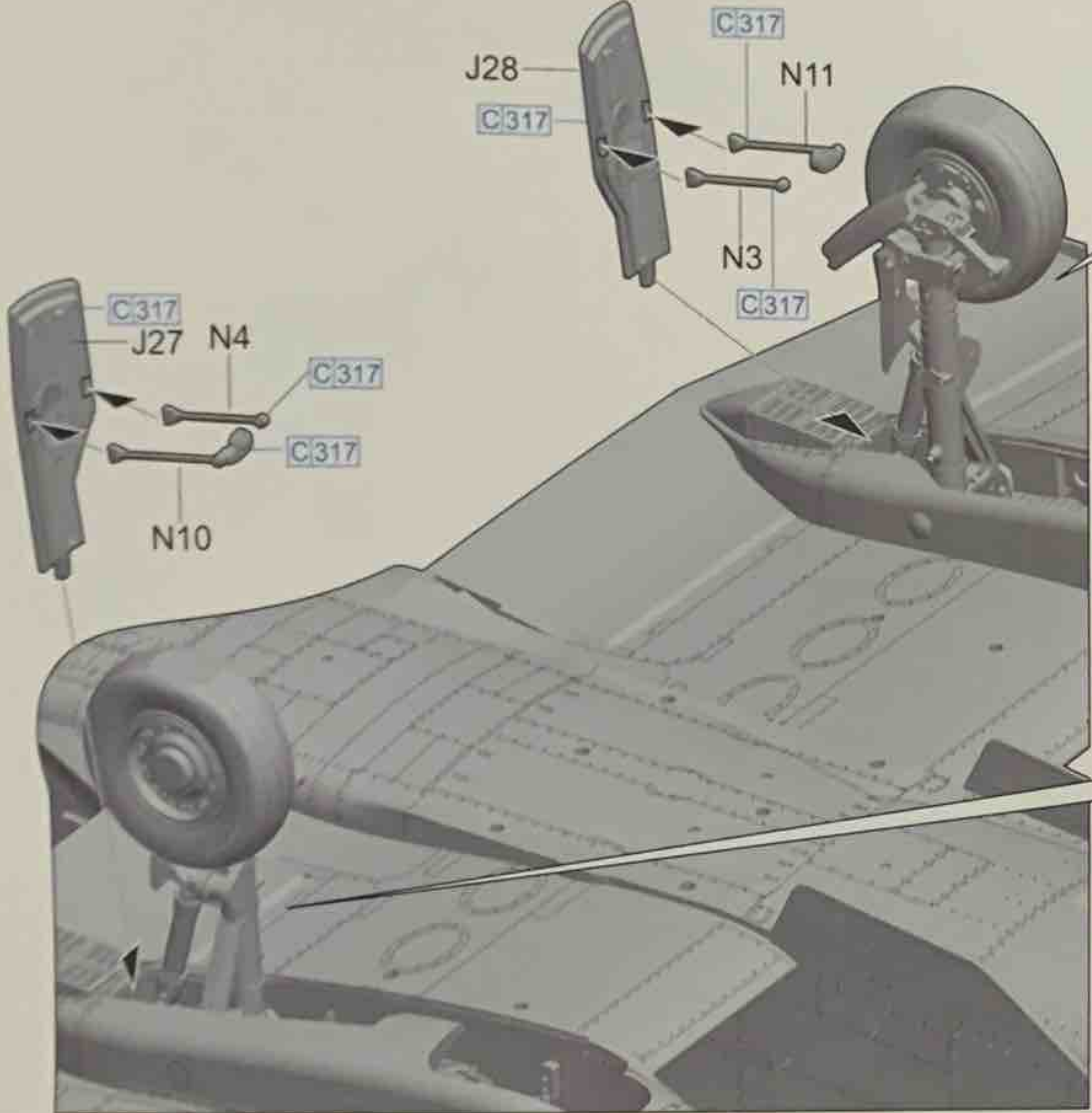
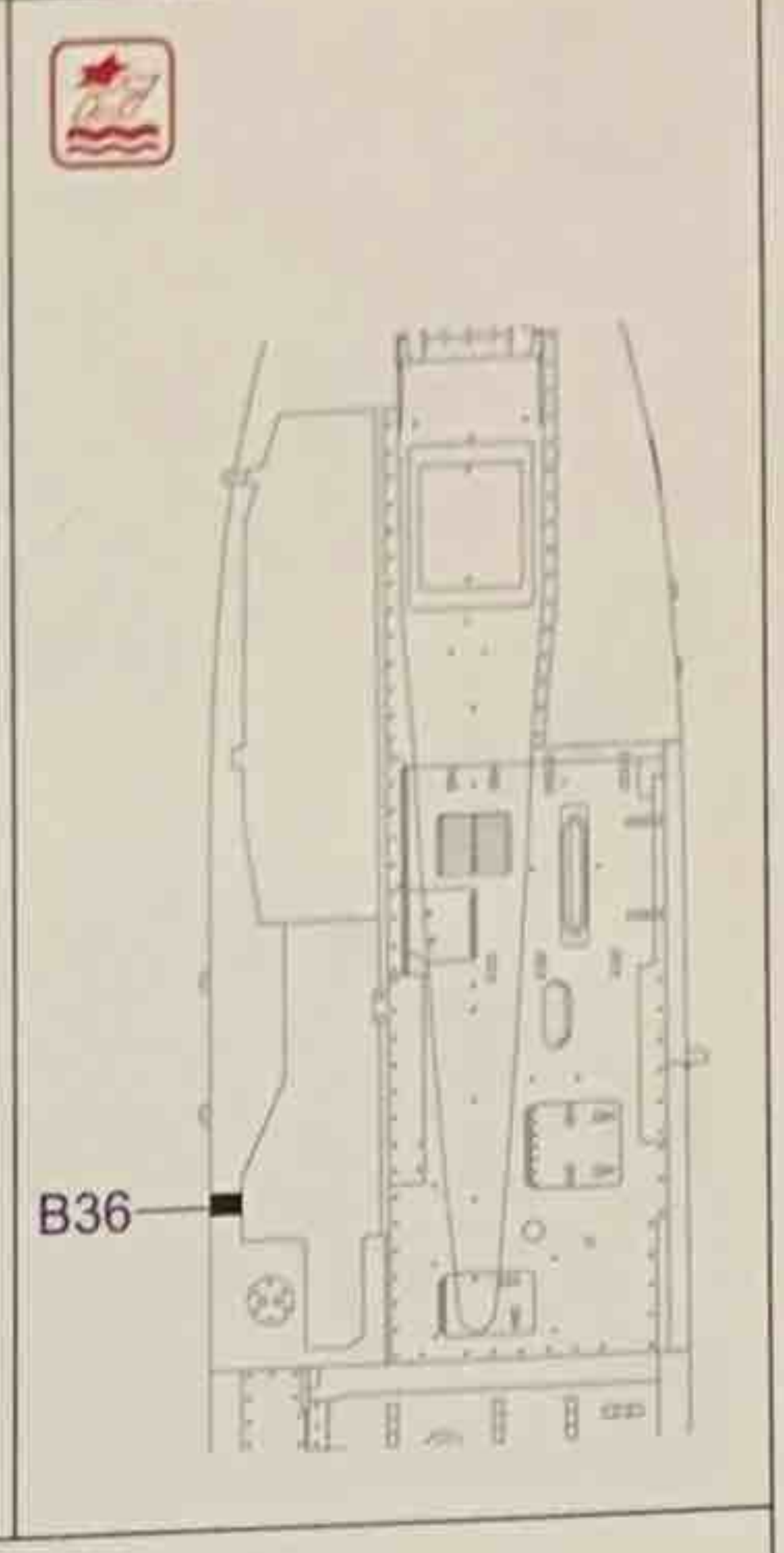
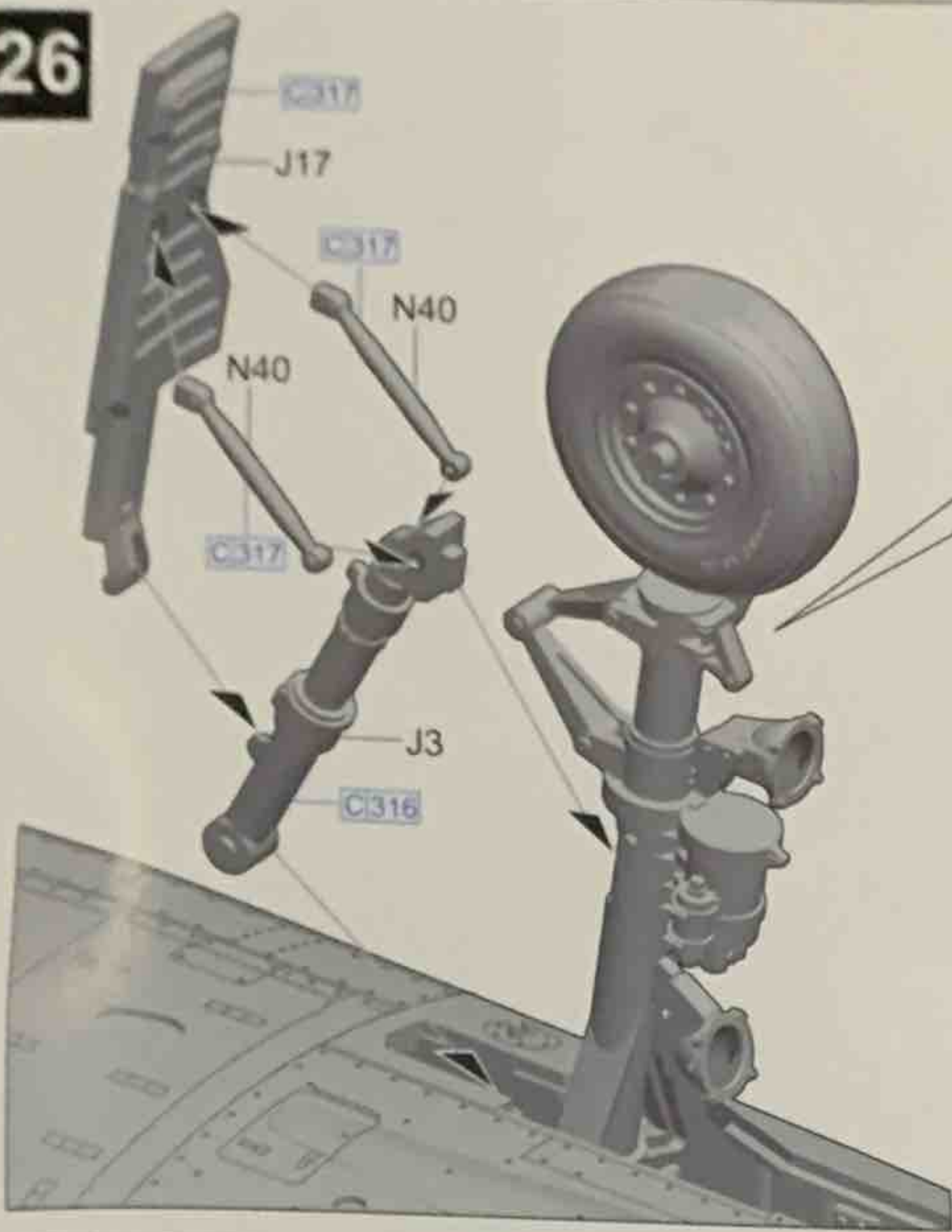

27

Canopy closed
舱盖关闭

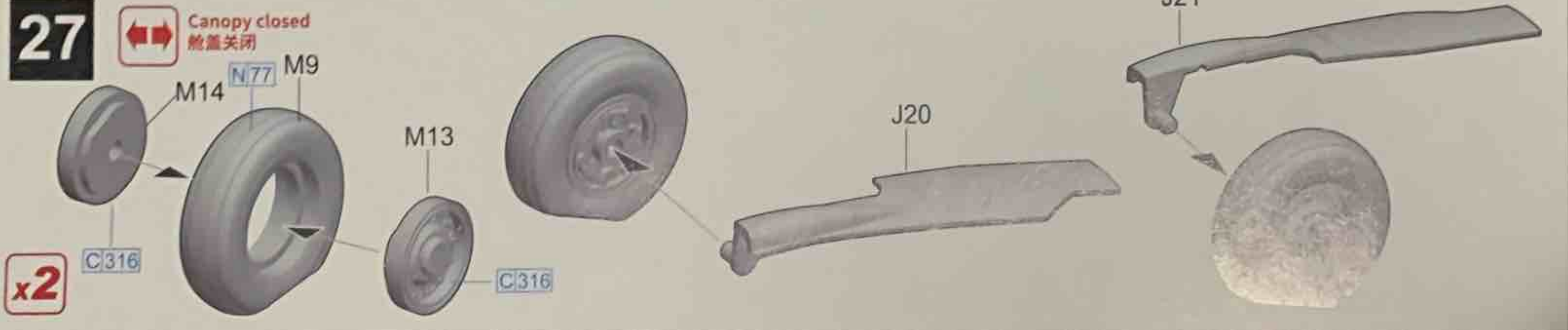

28

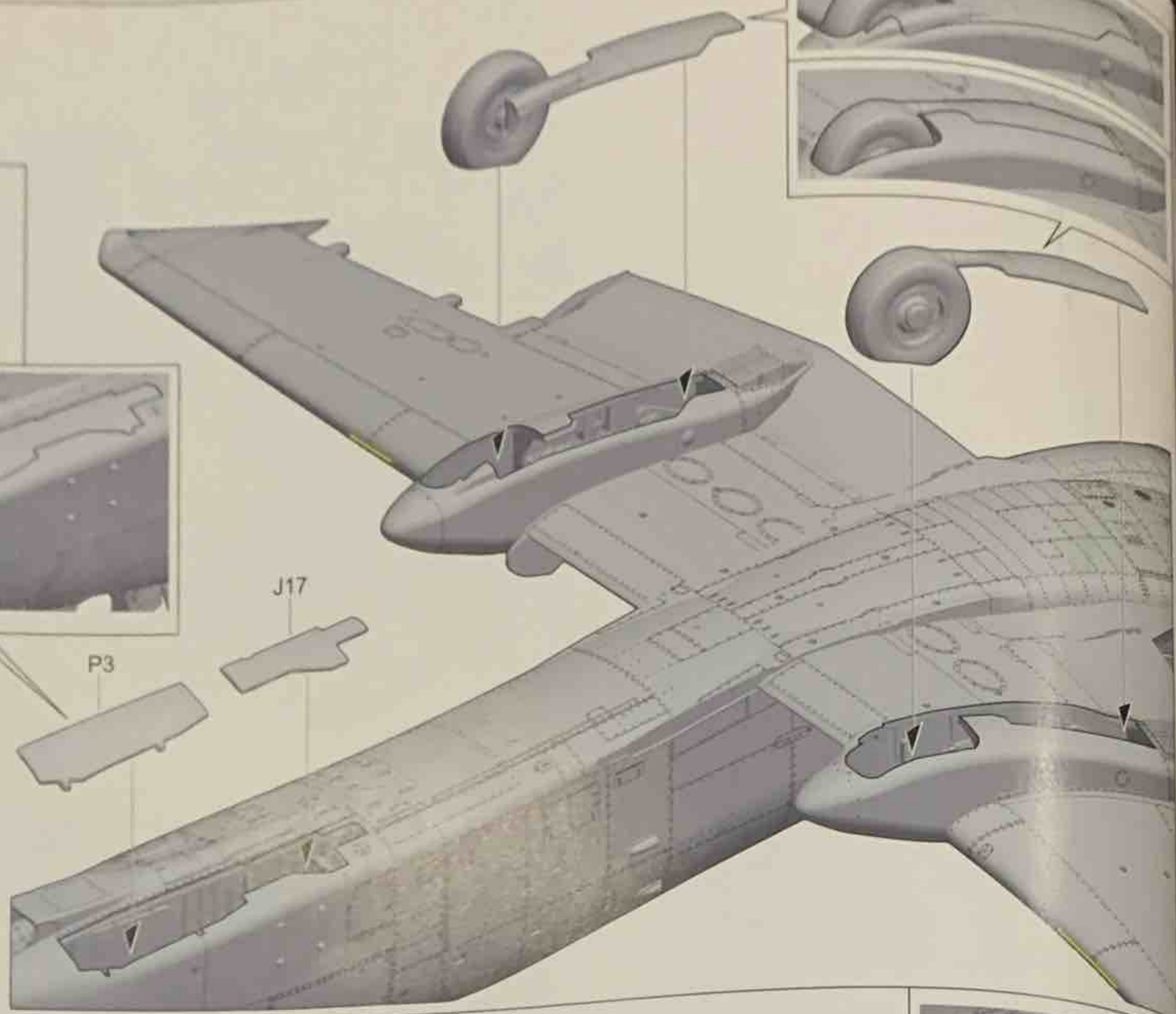
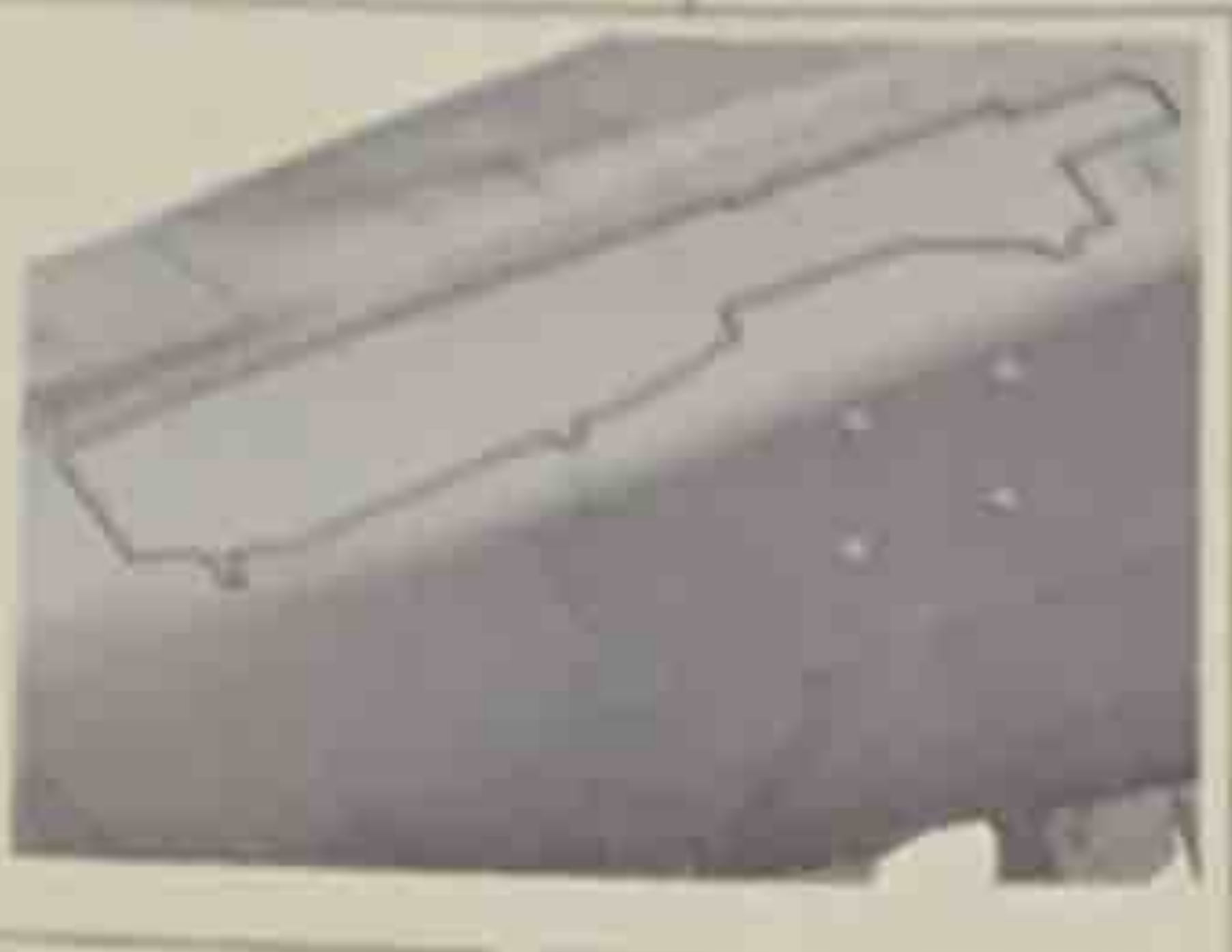

29

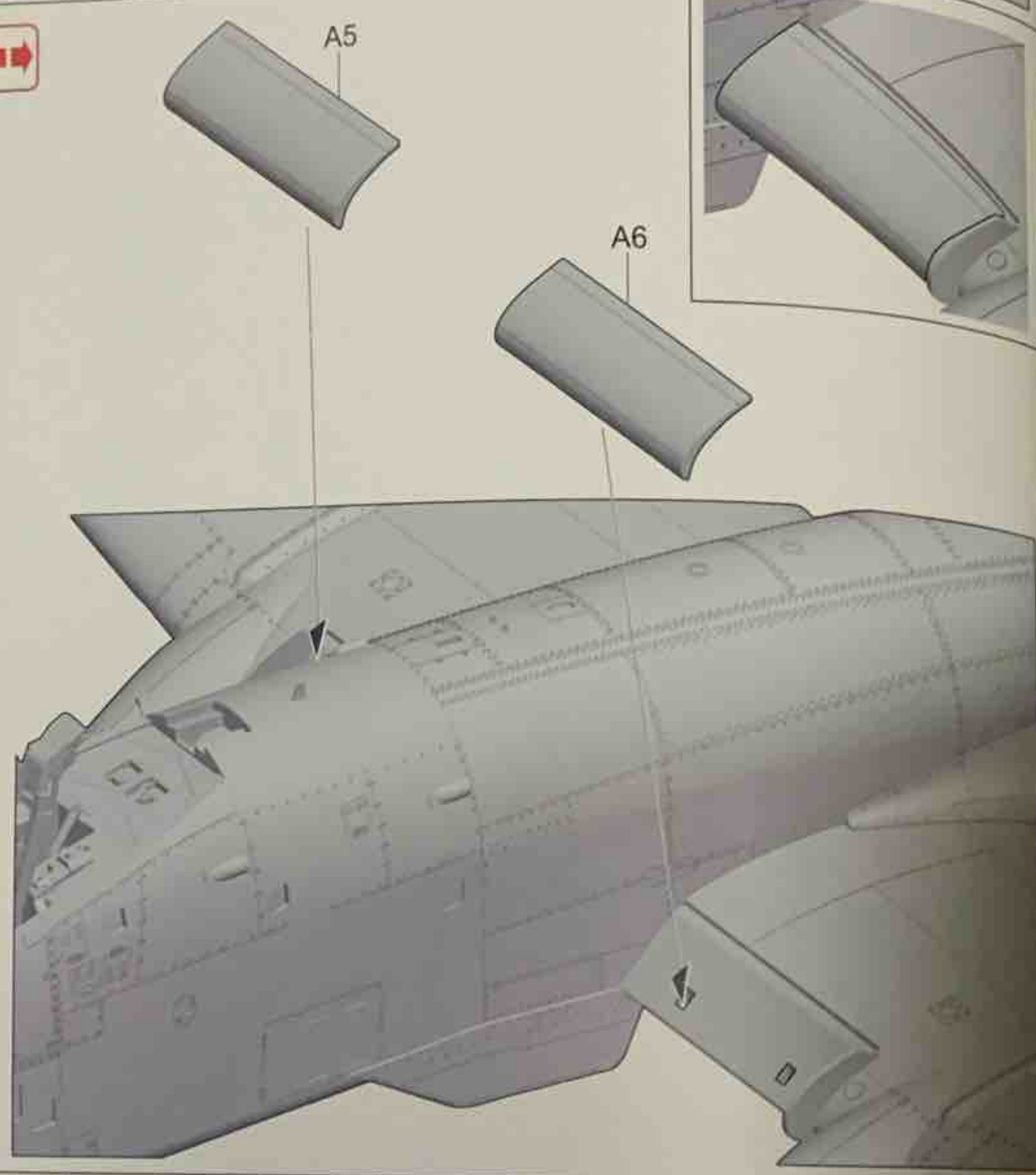
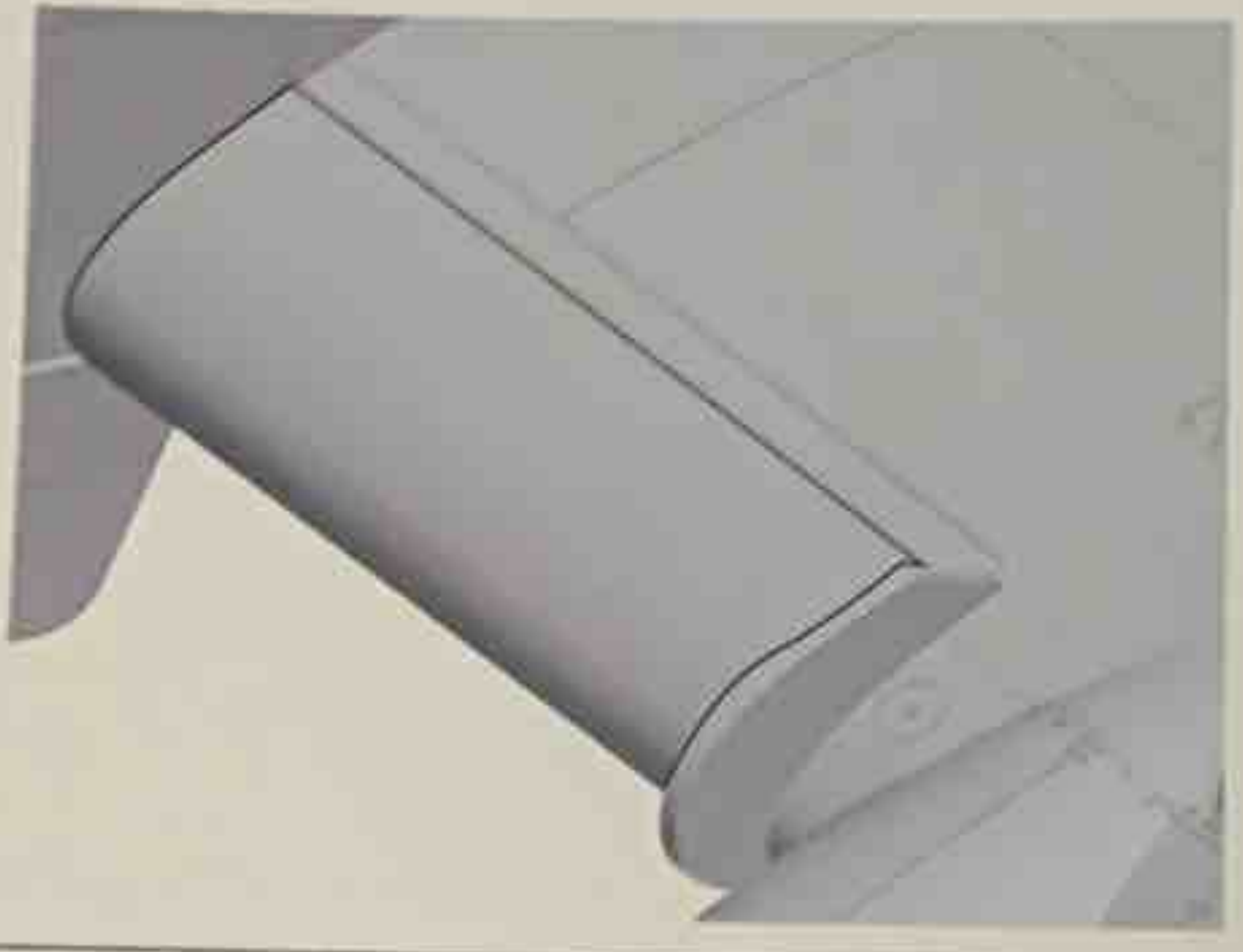
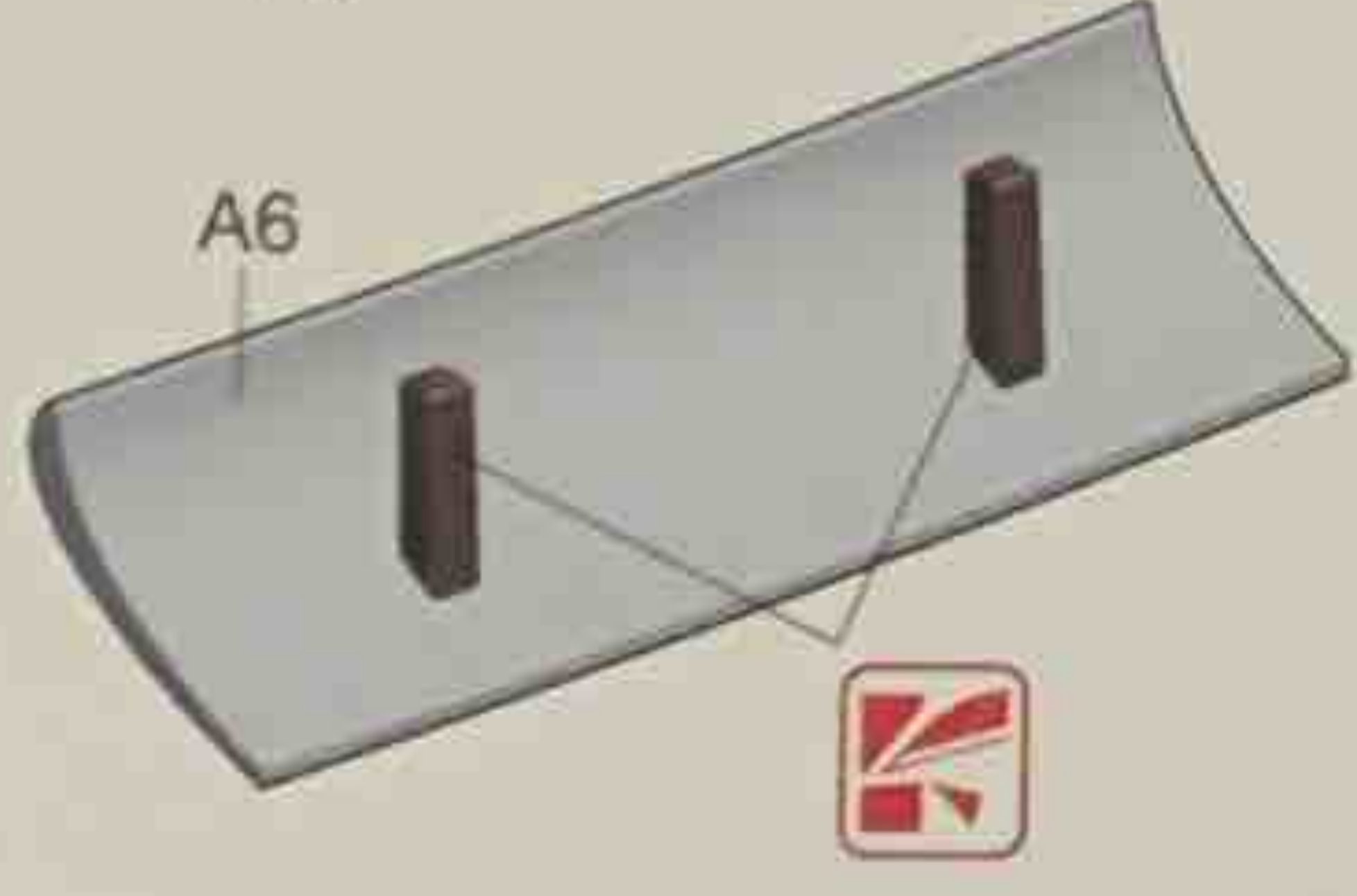
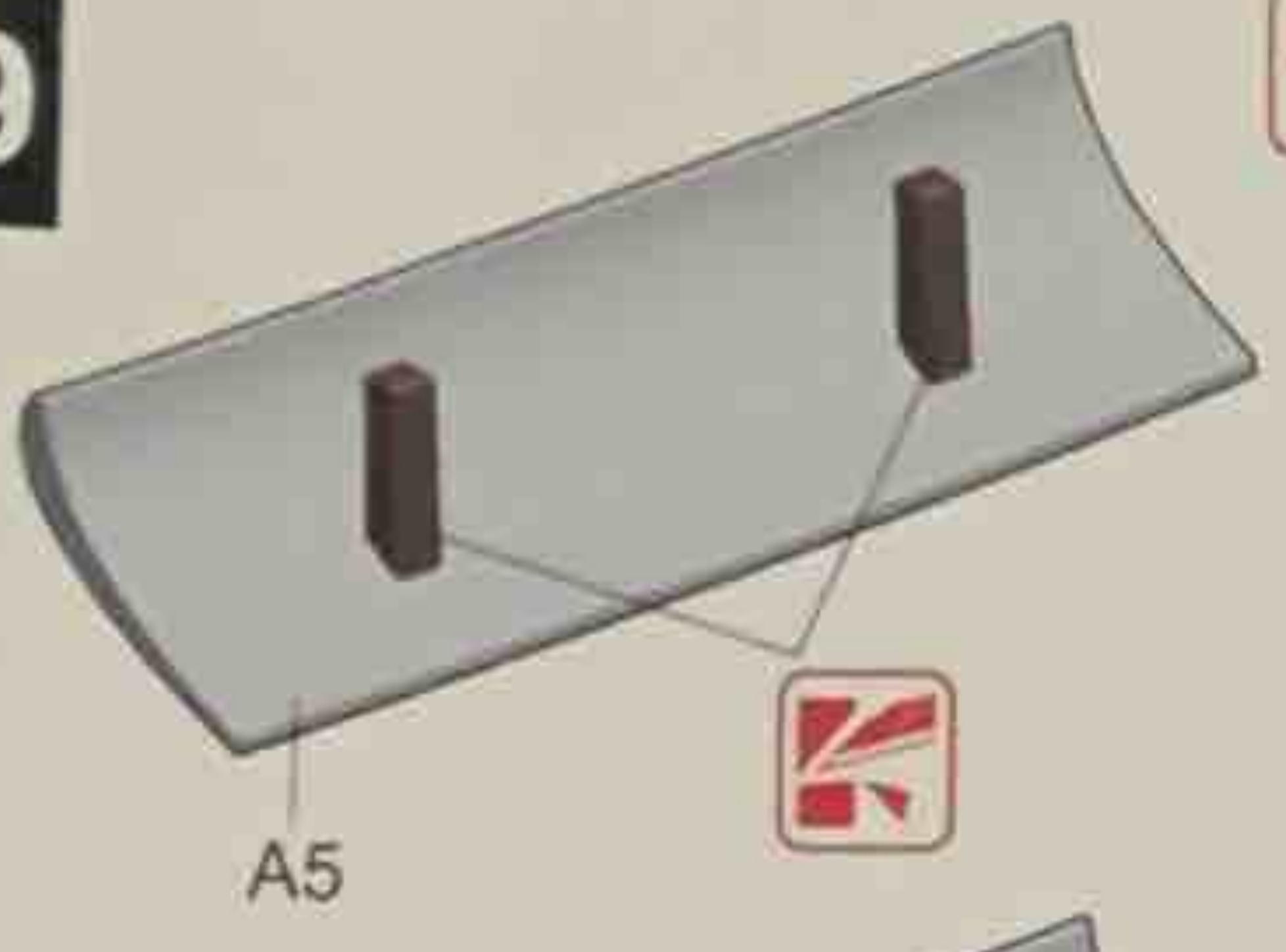

30

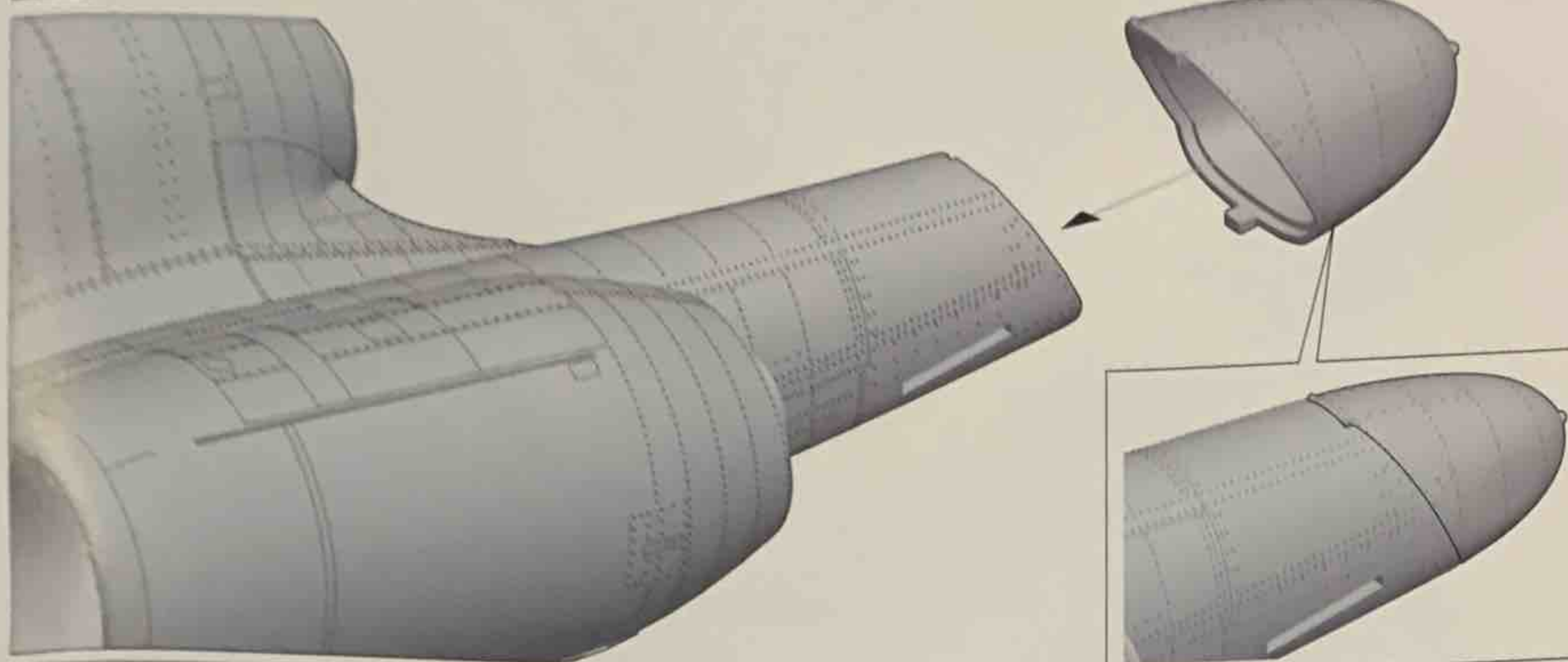

31

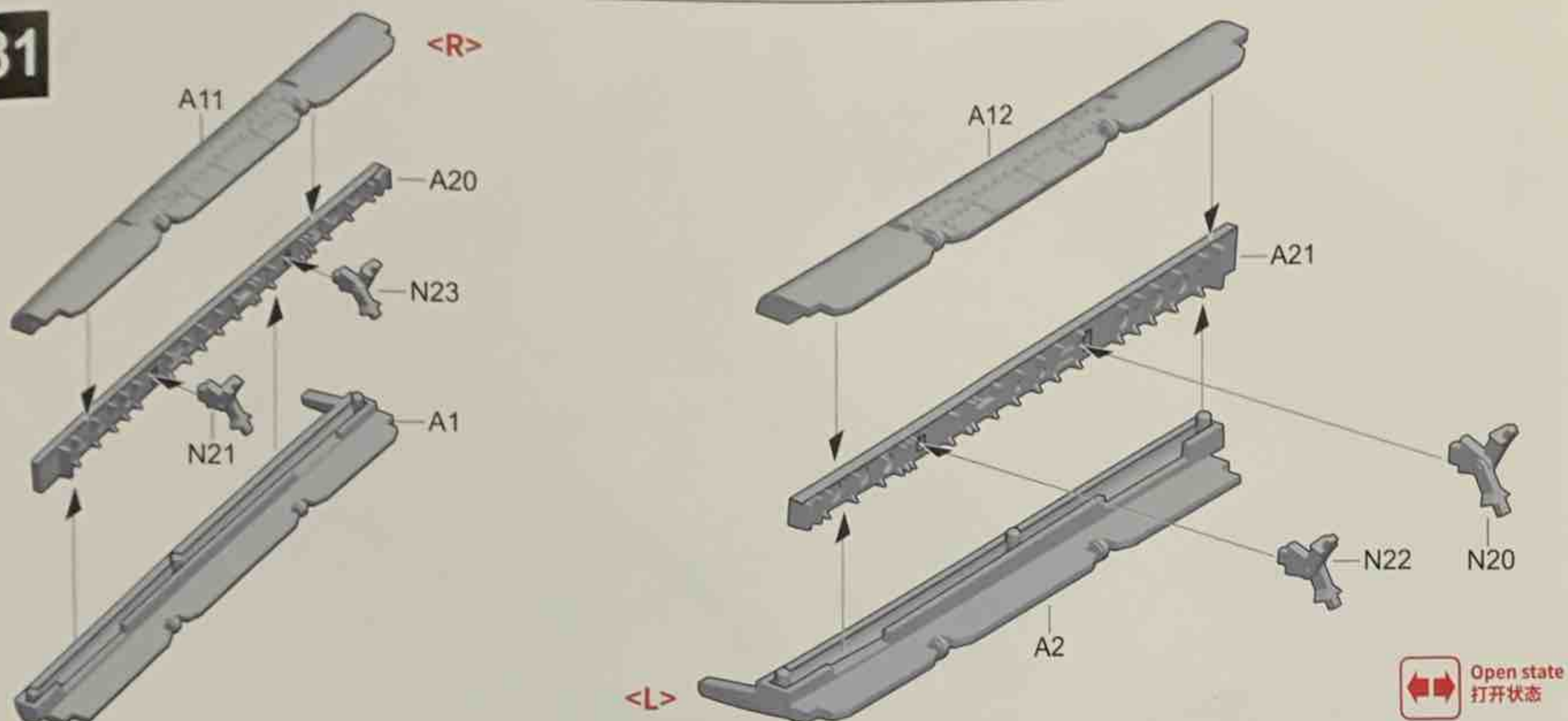

31

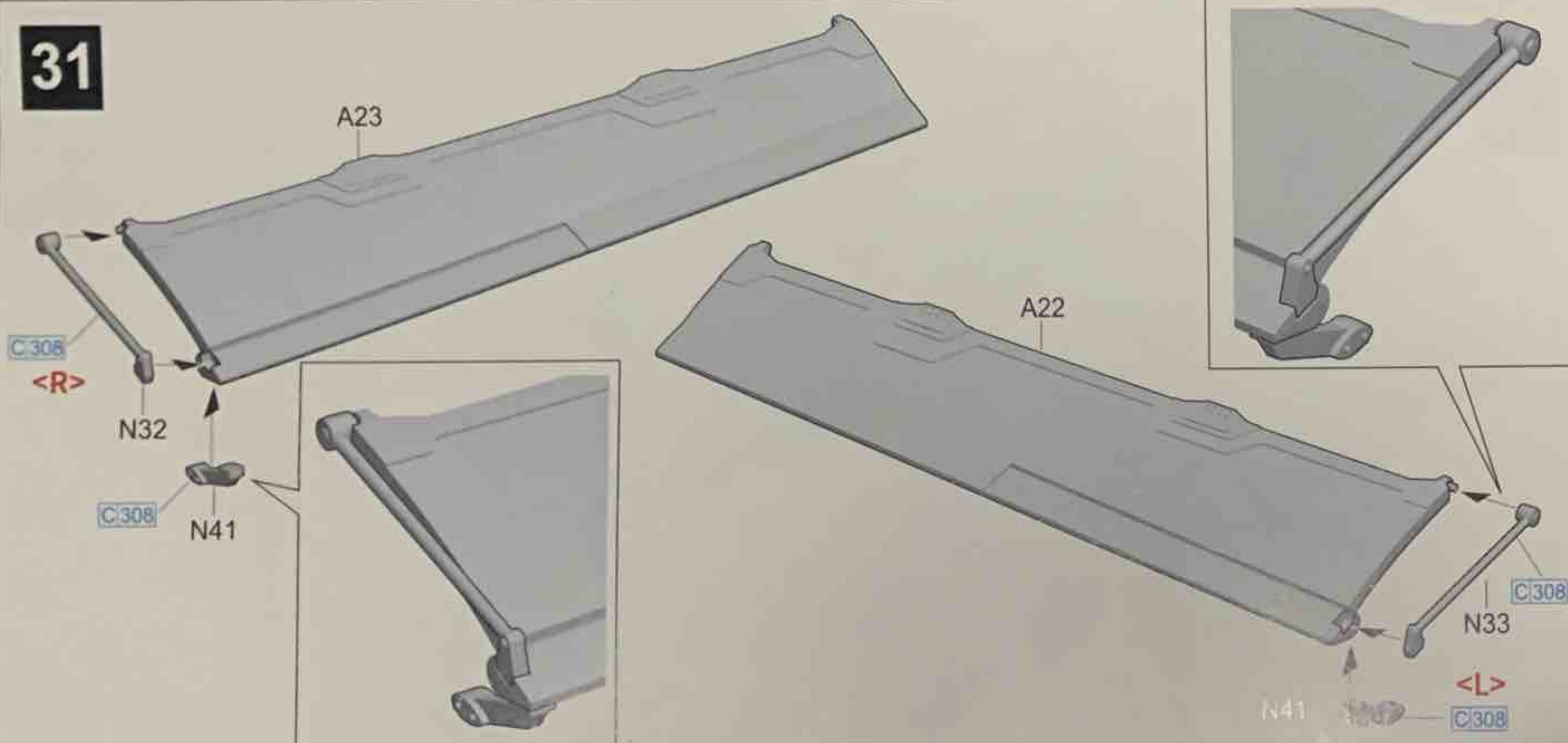

32

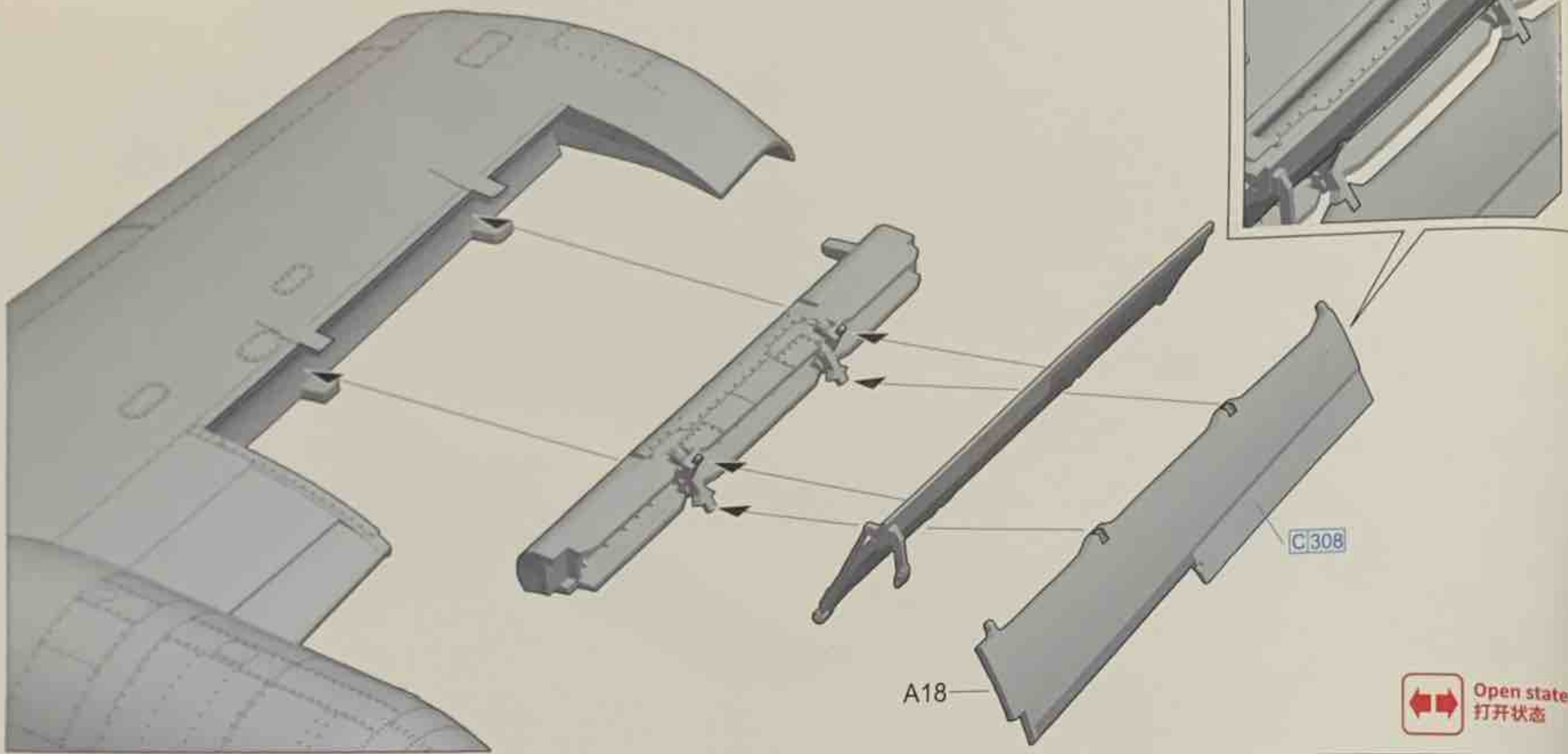
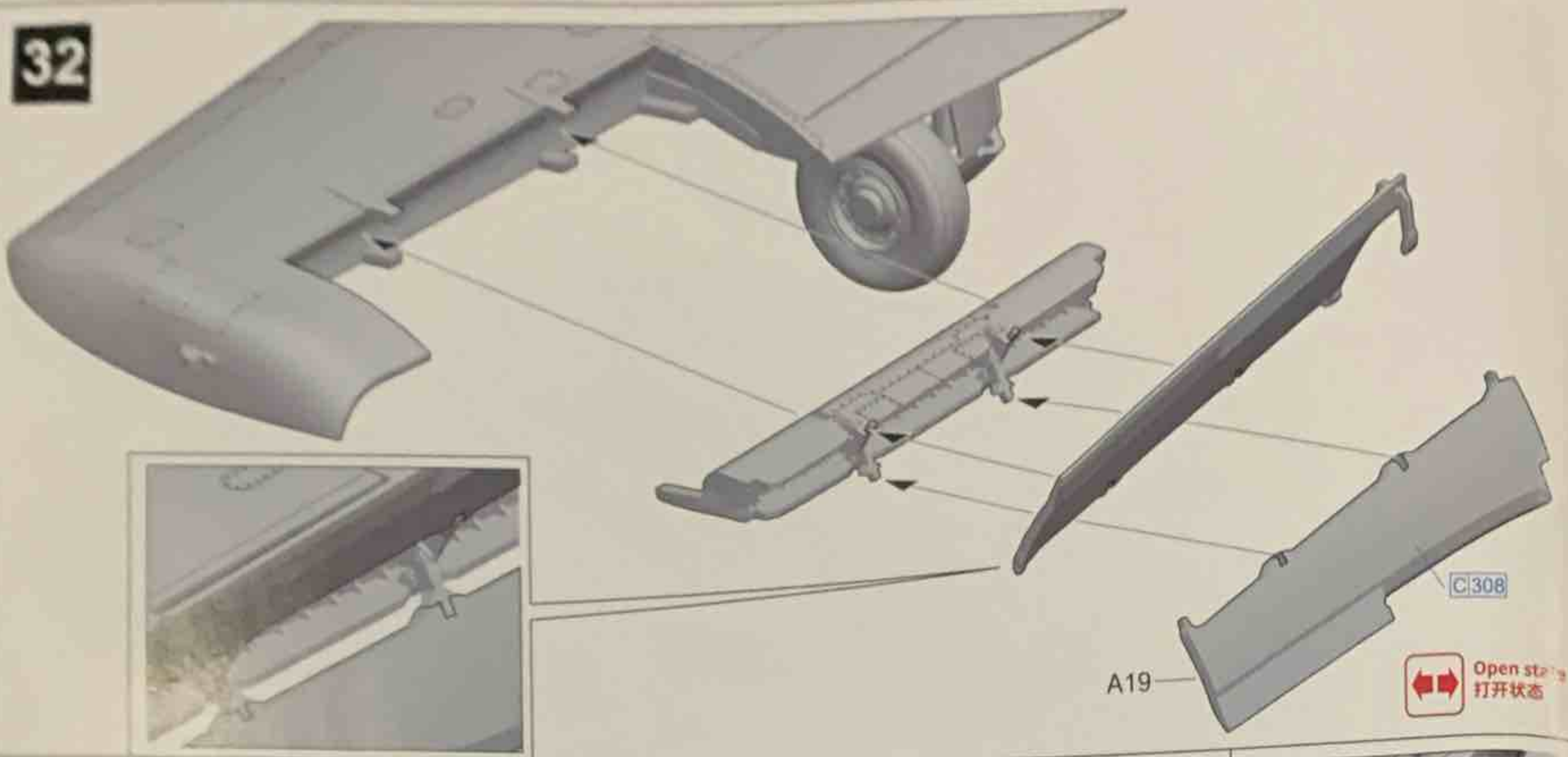

33

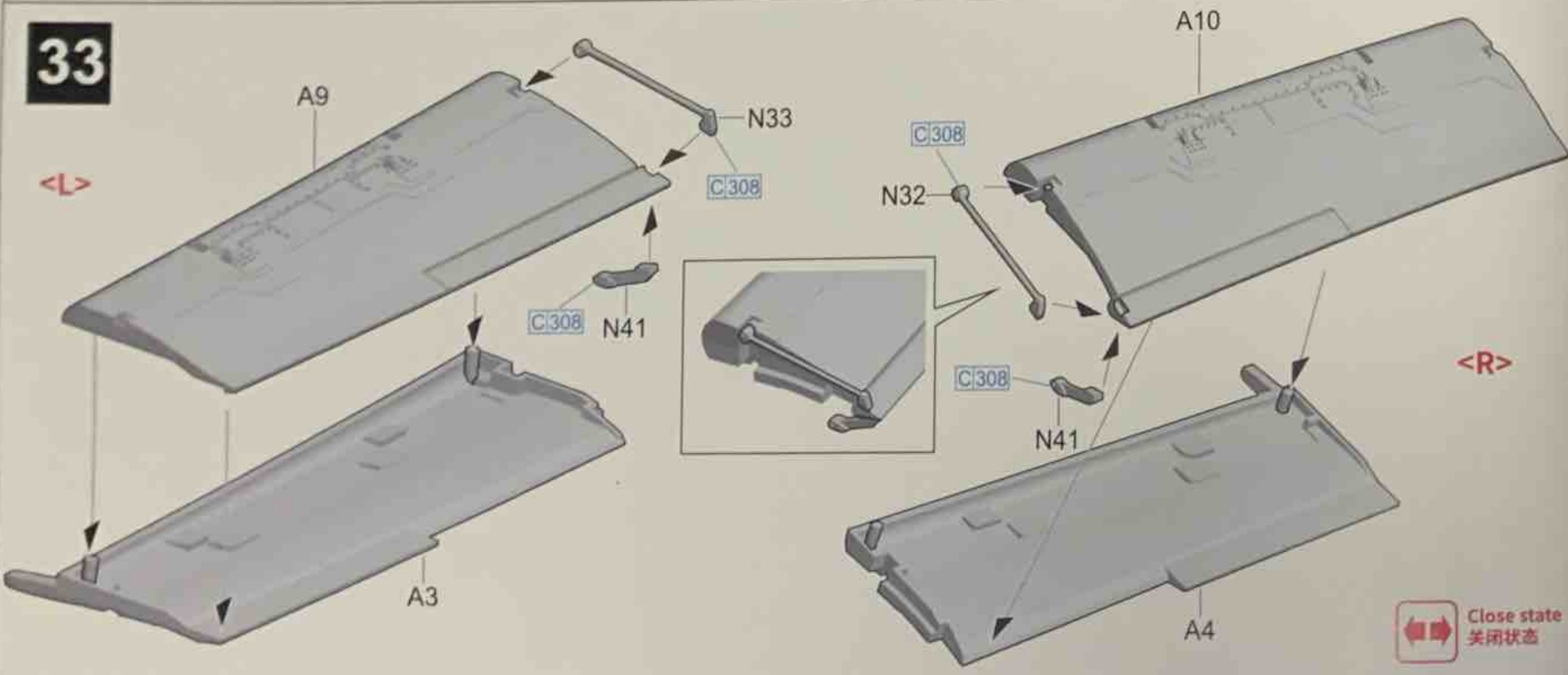

34

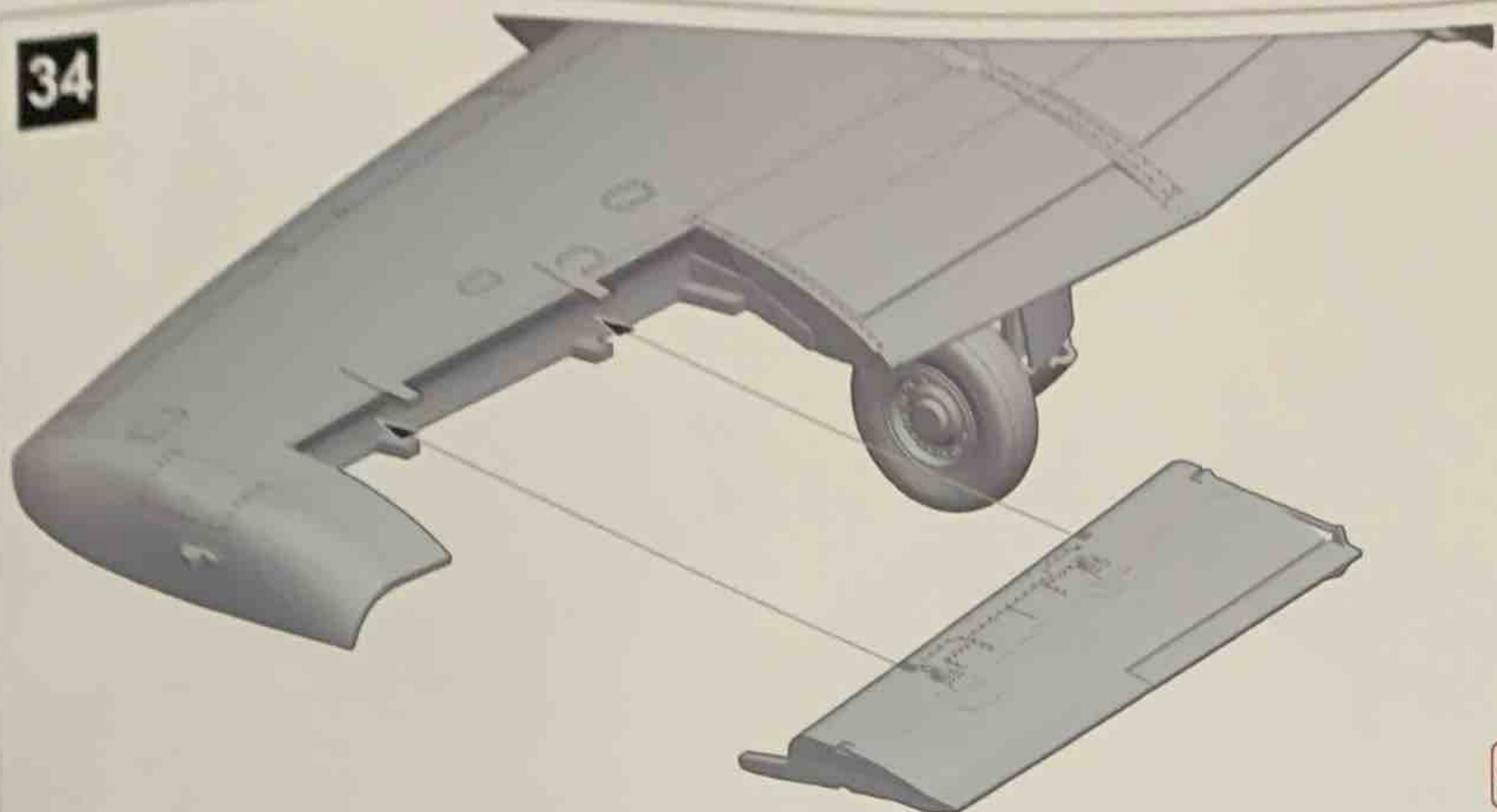

Close state
关闭状态

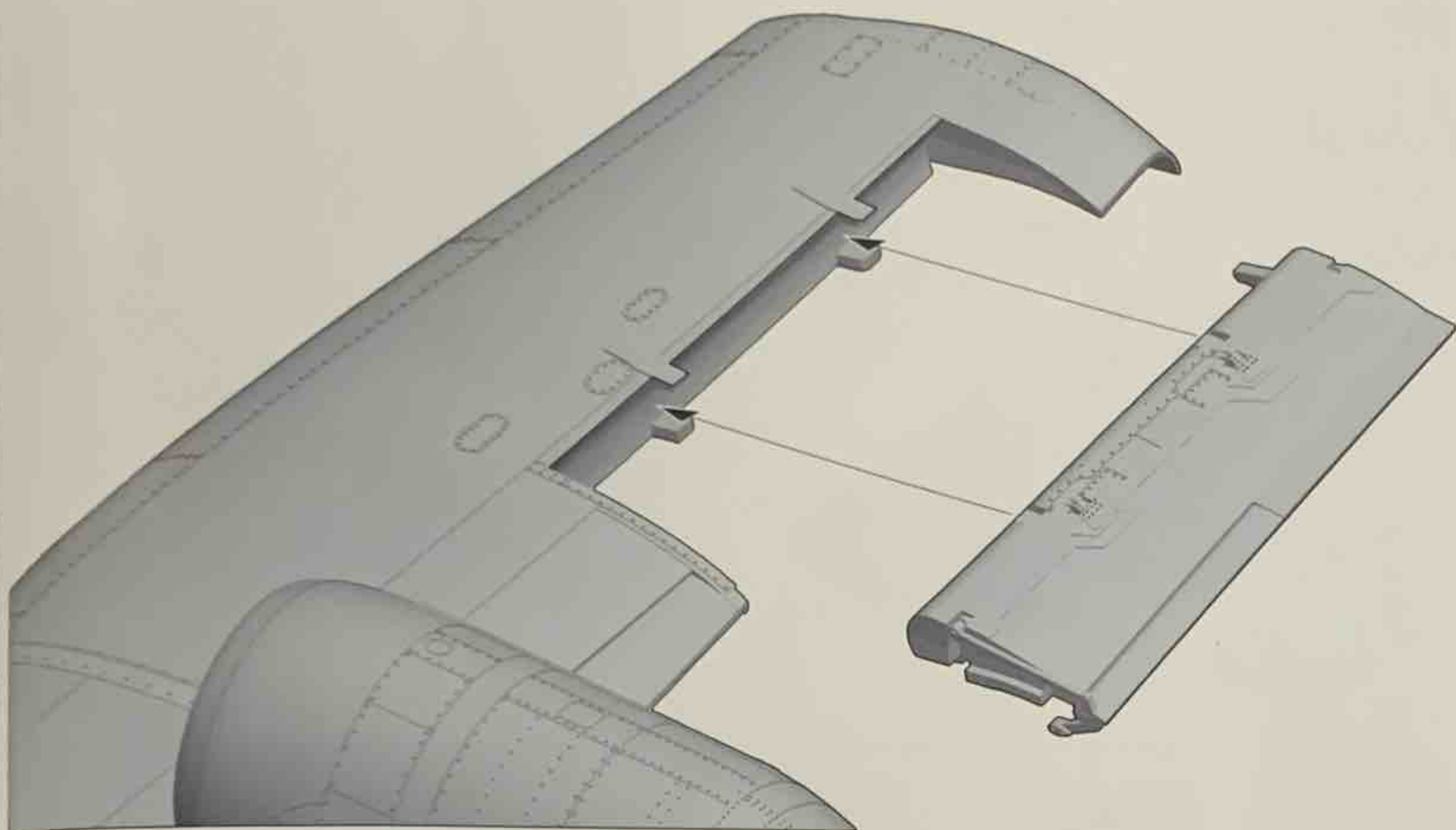

Close state
关闭状态

35

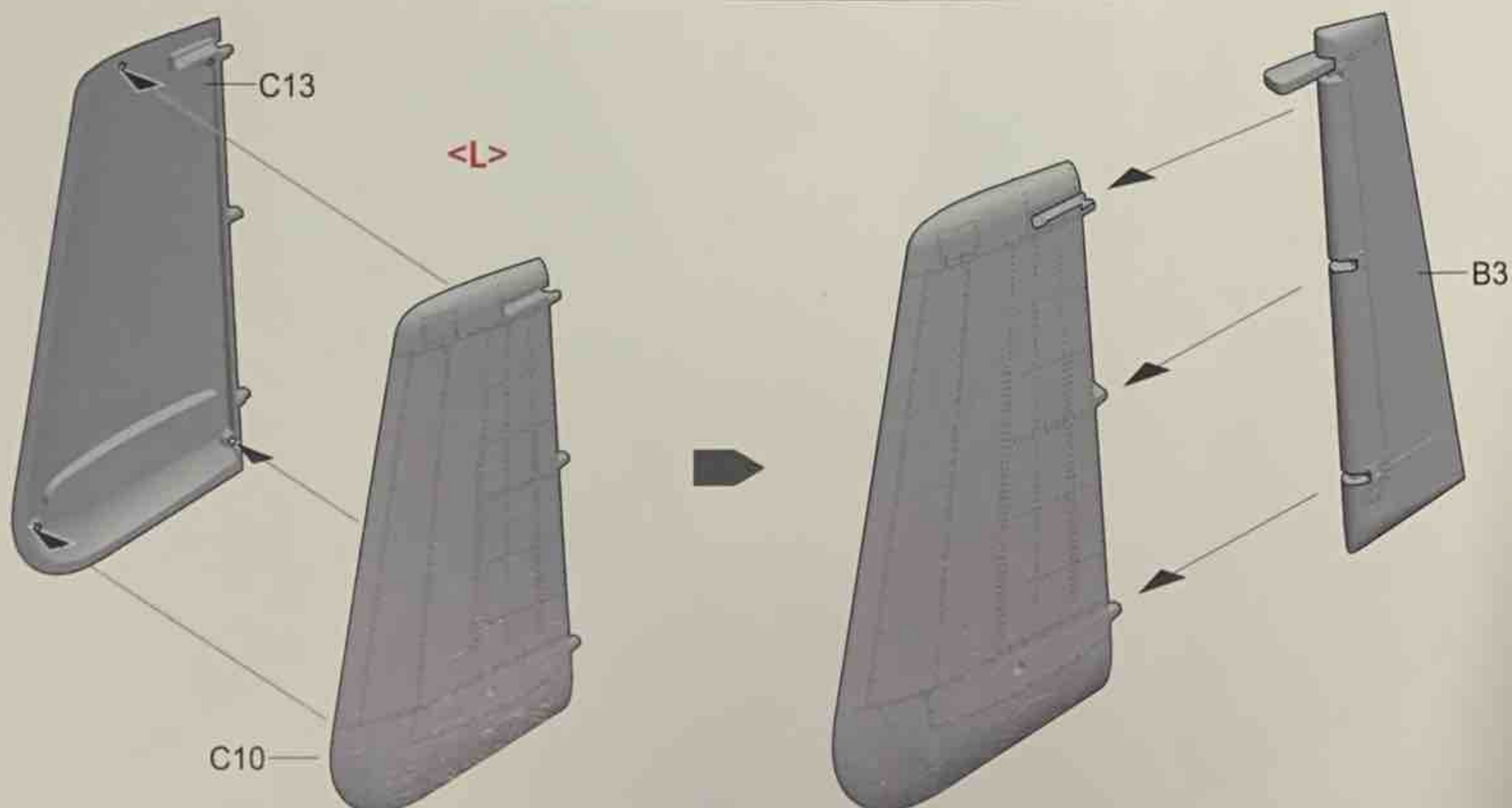

35



M15

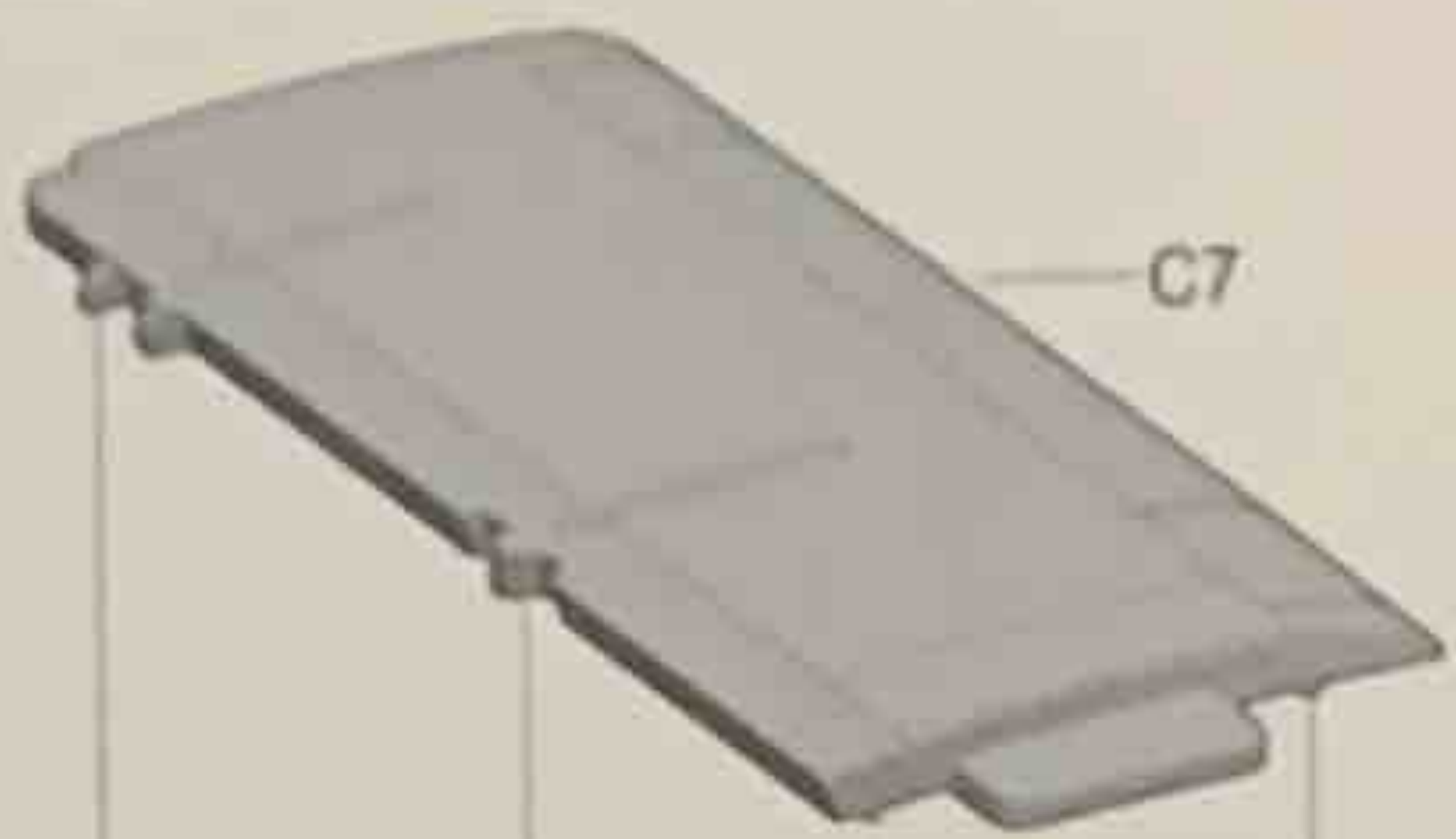

C7

C8

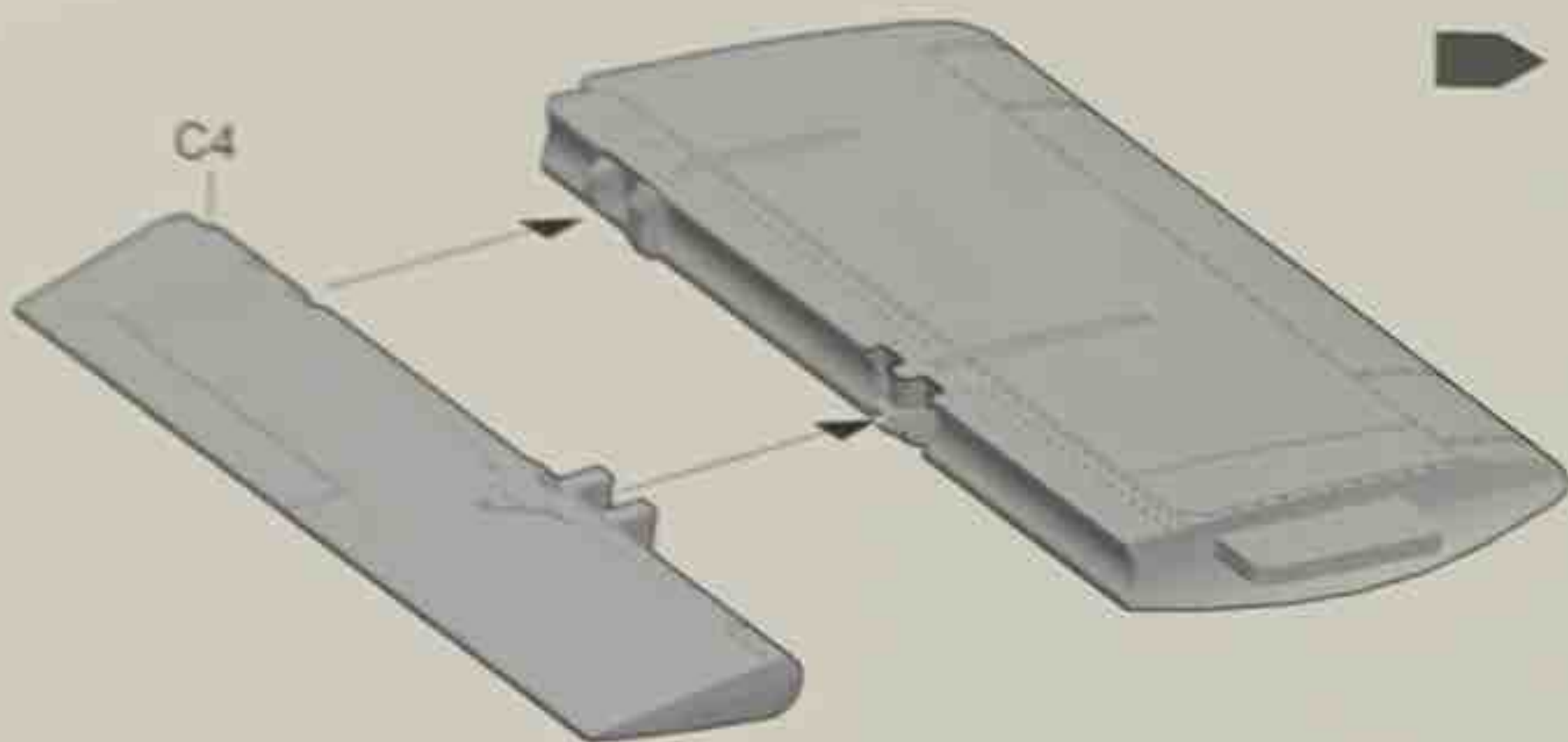
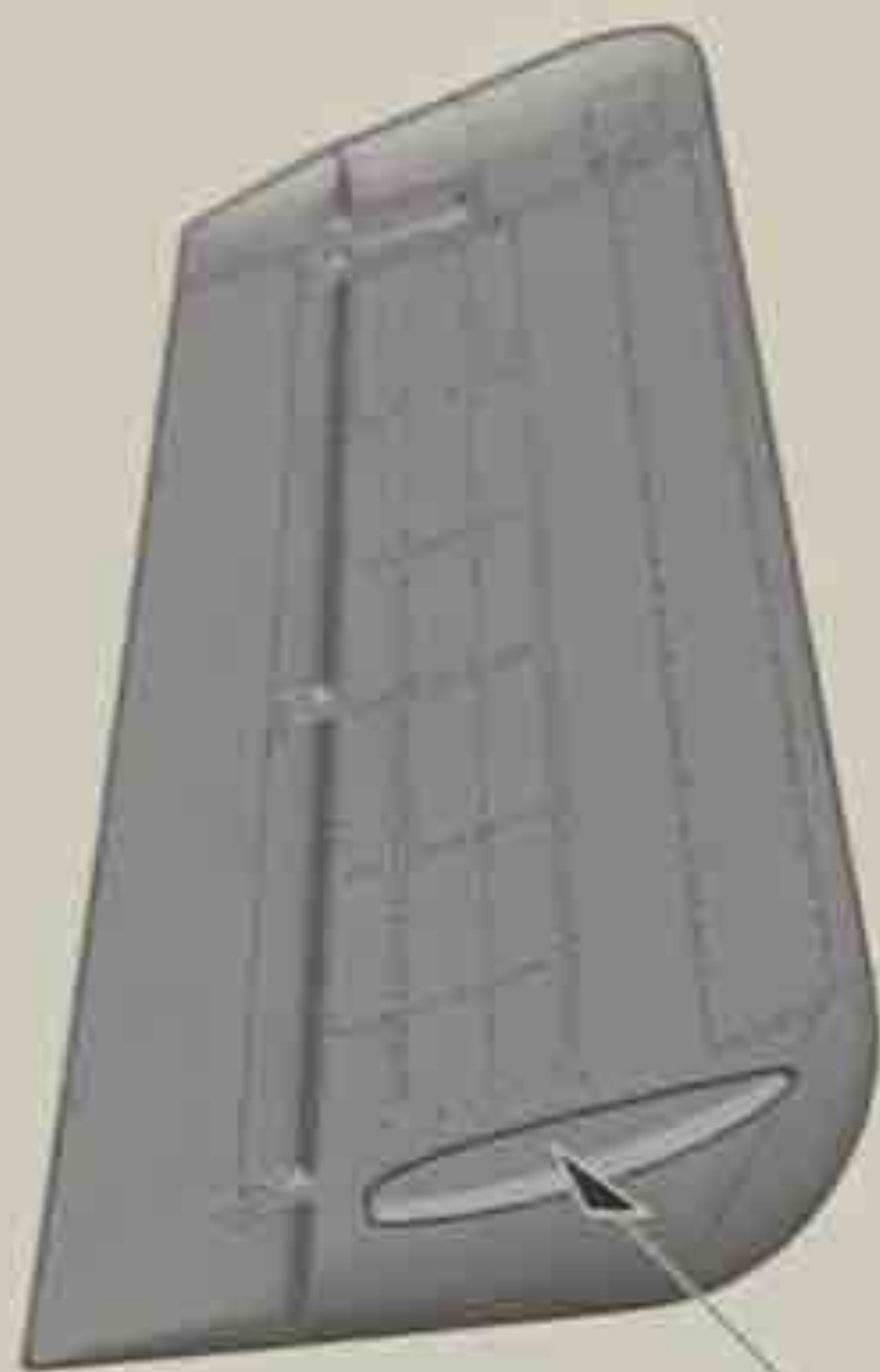

C4

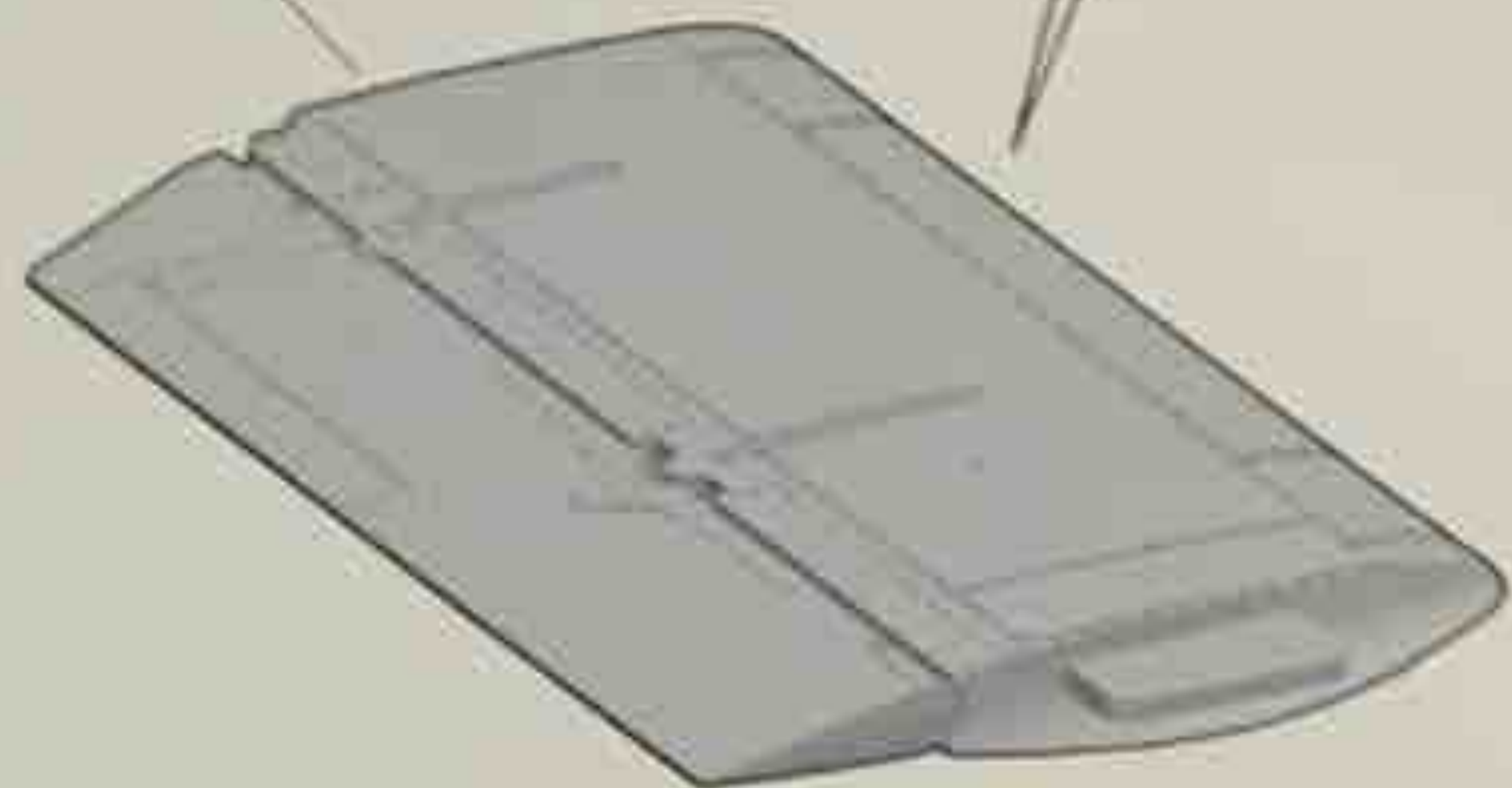

36

<R>



C11

C12

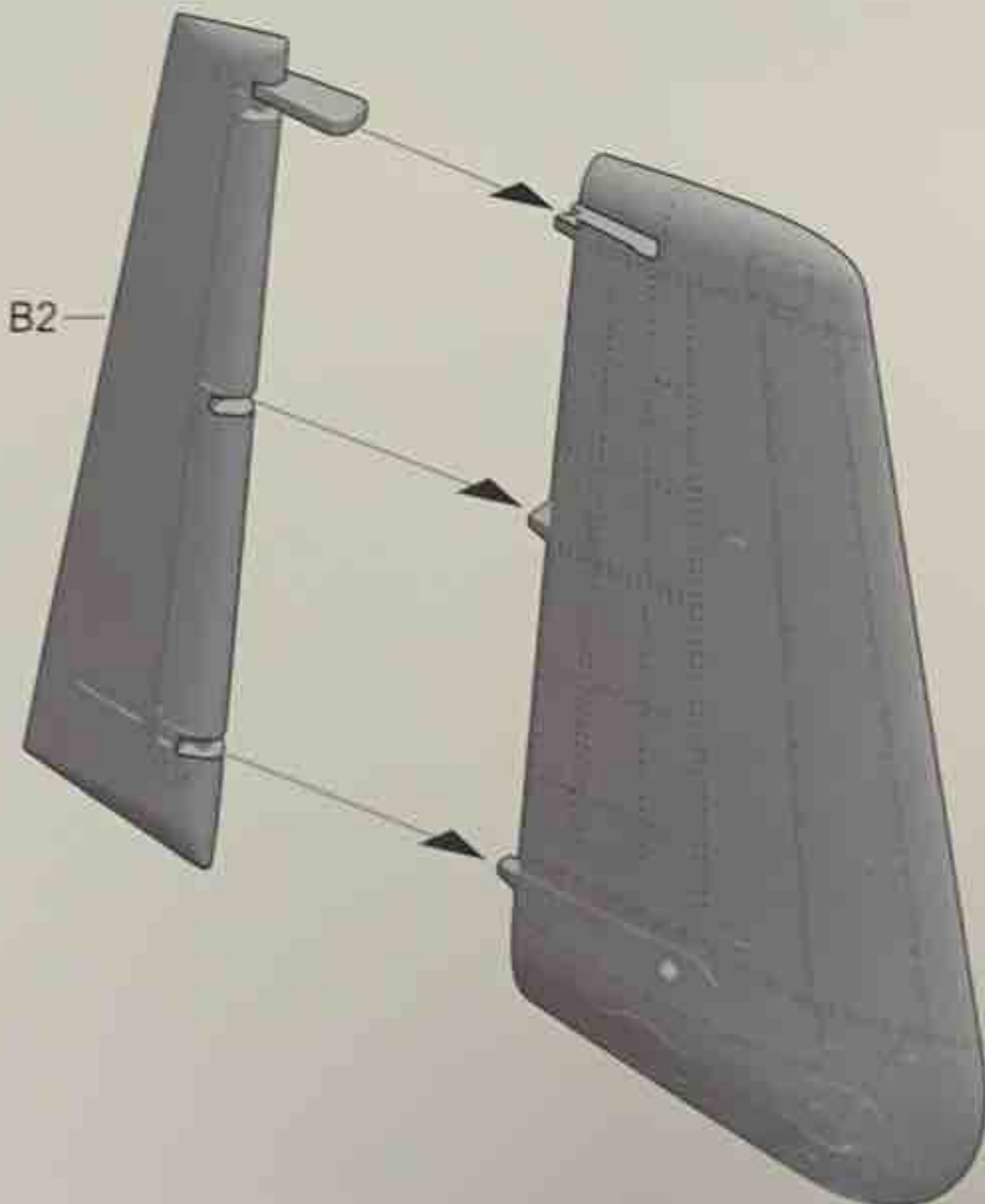

B2

36



37

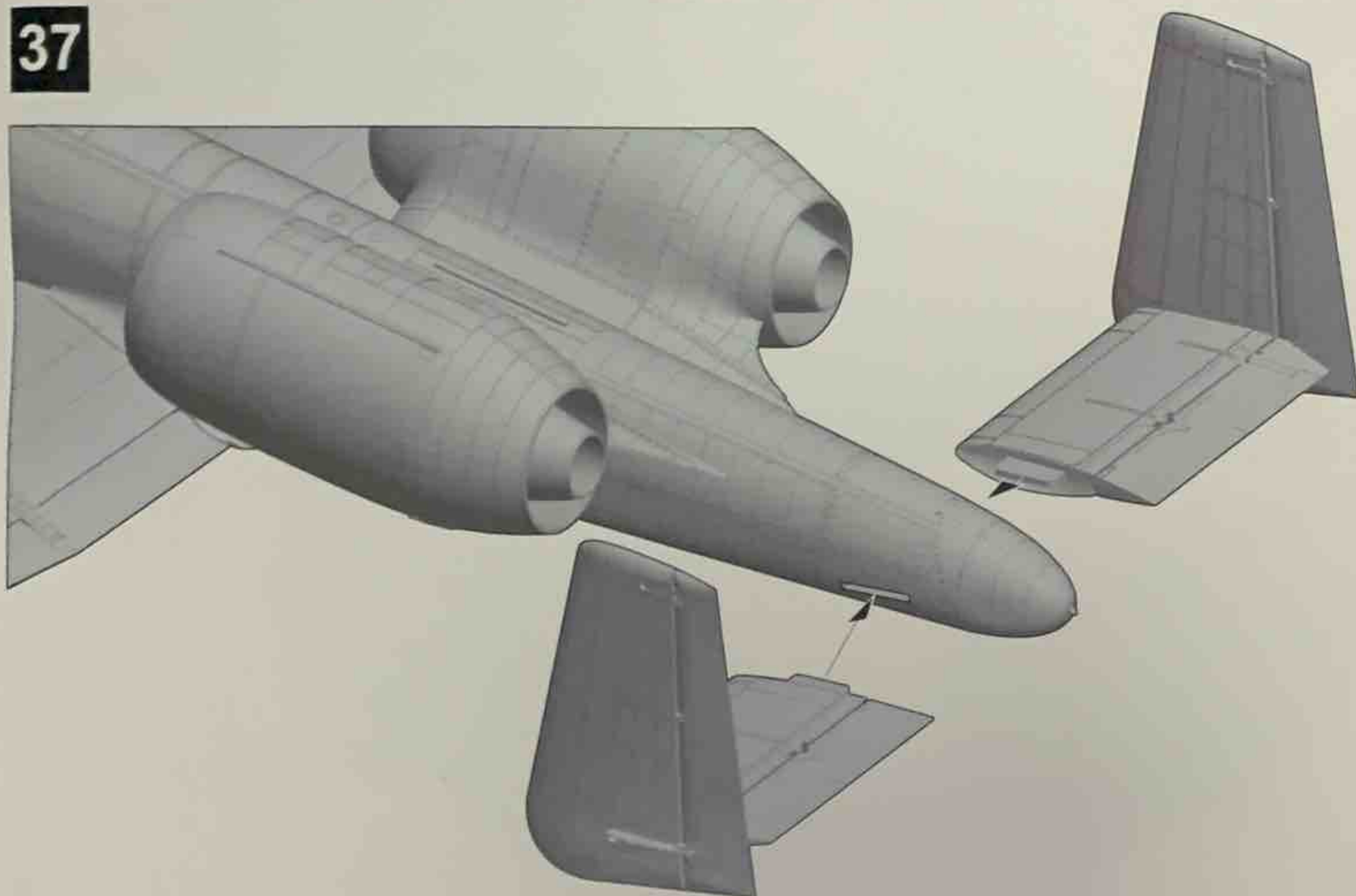

38

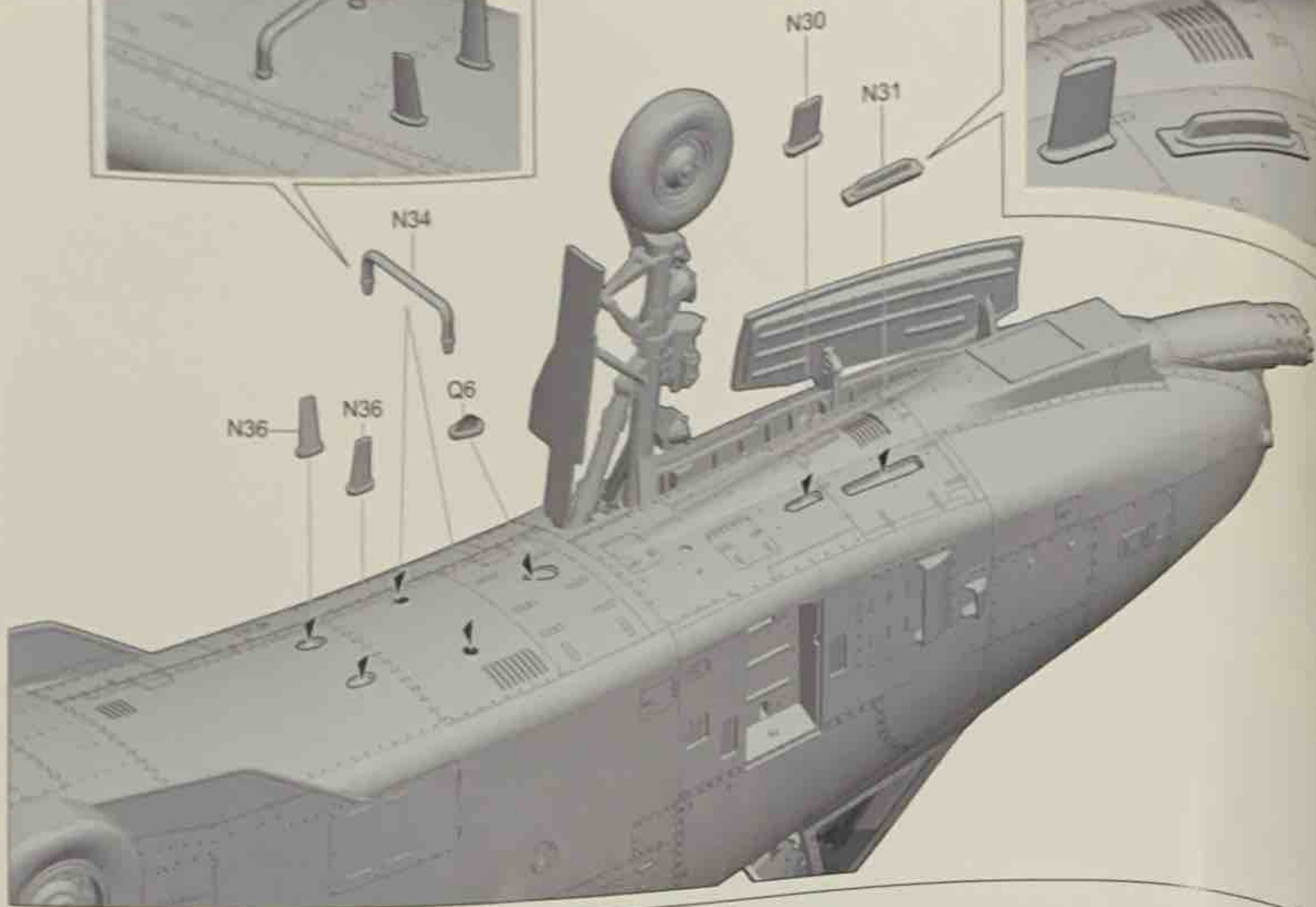
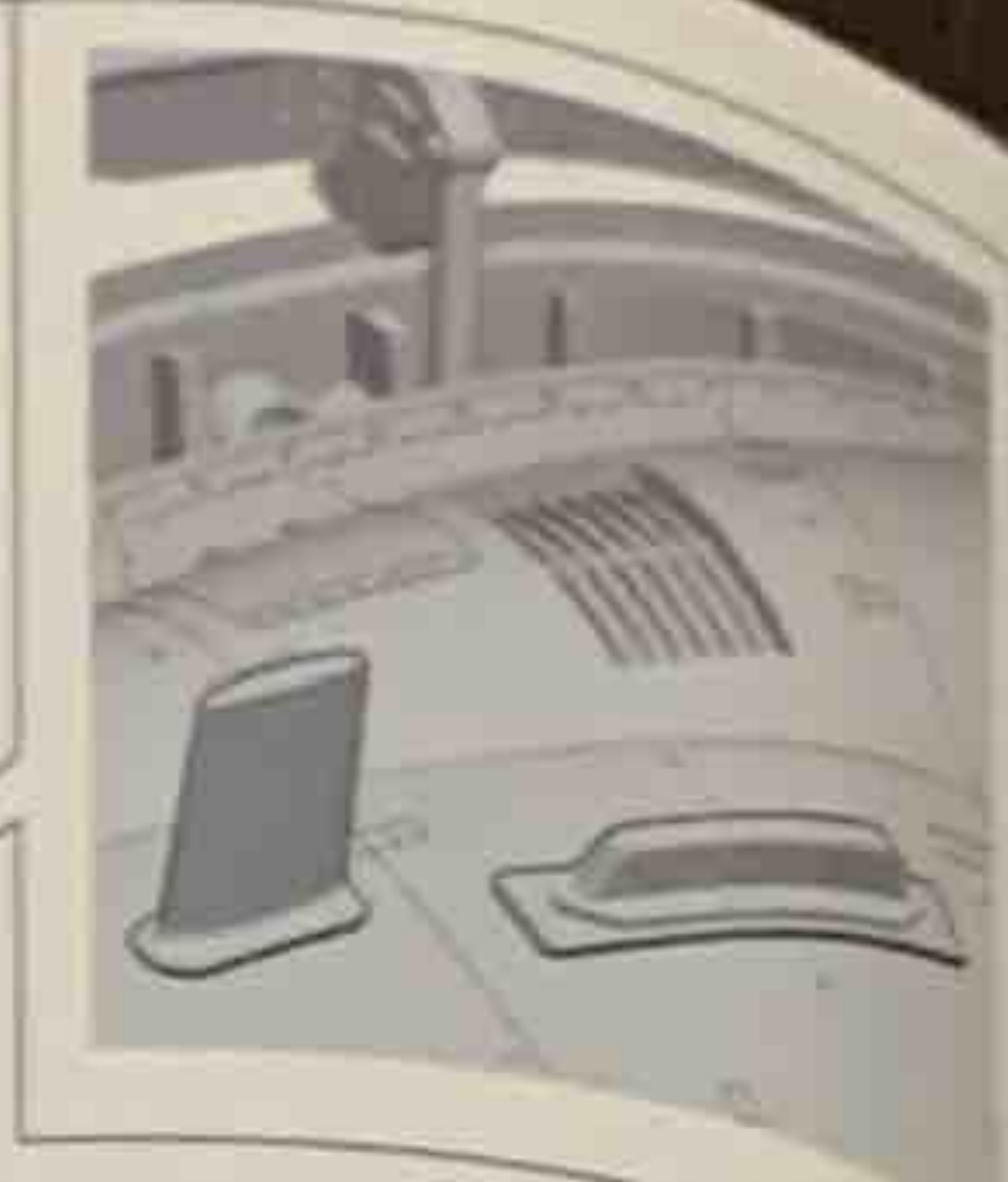
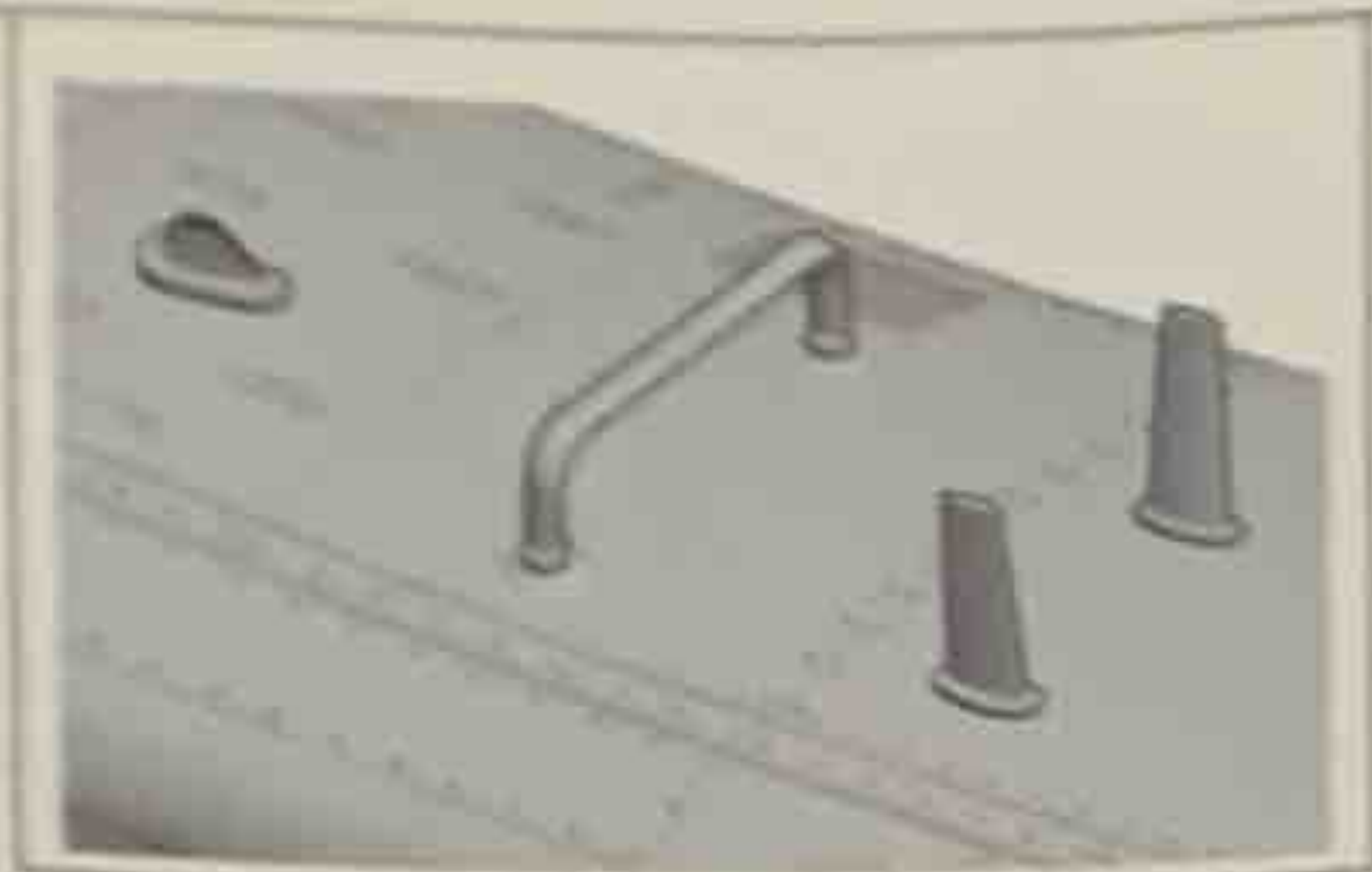

38

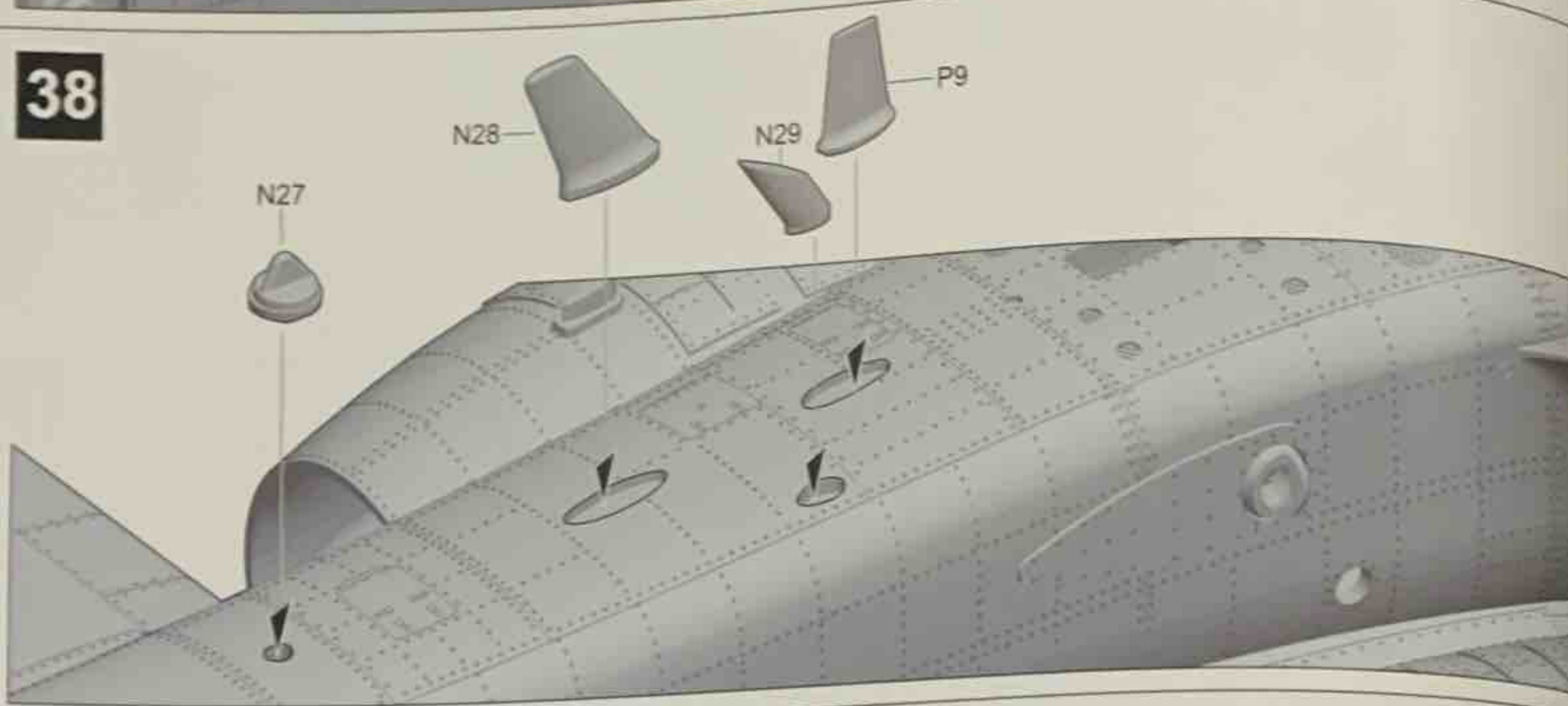

39

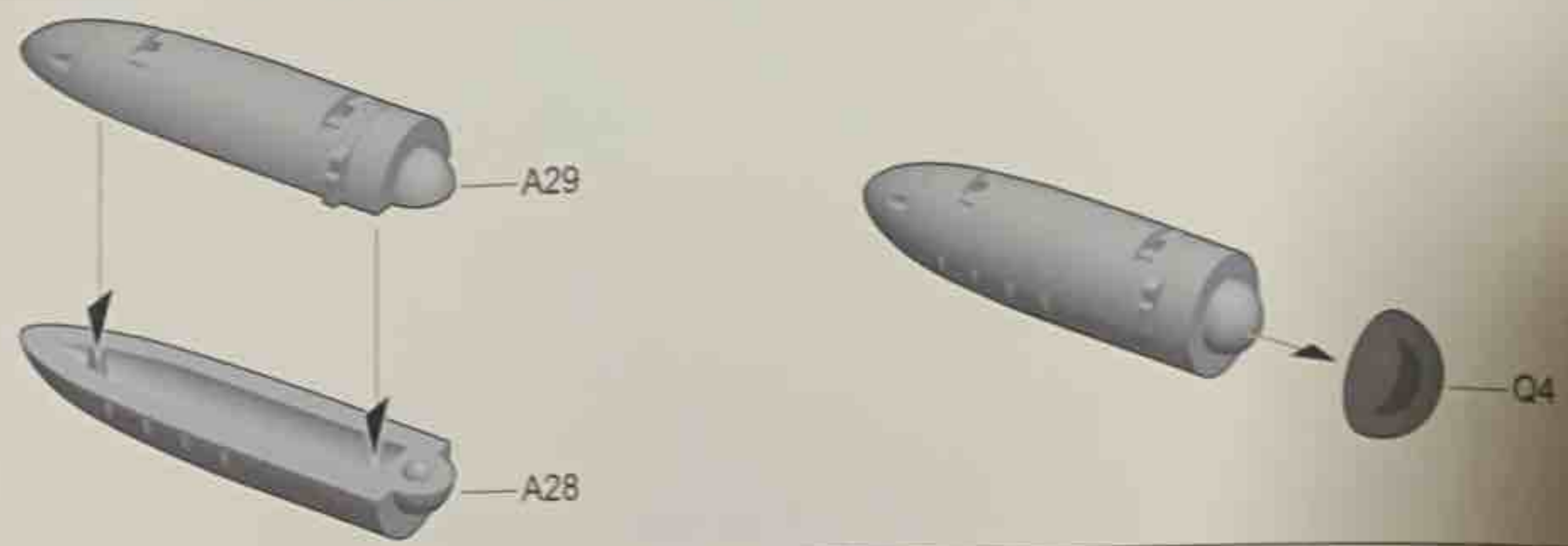

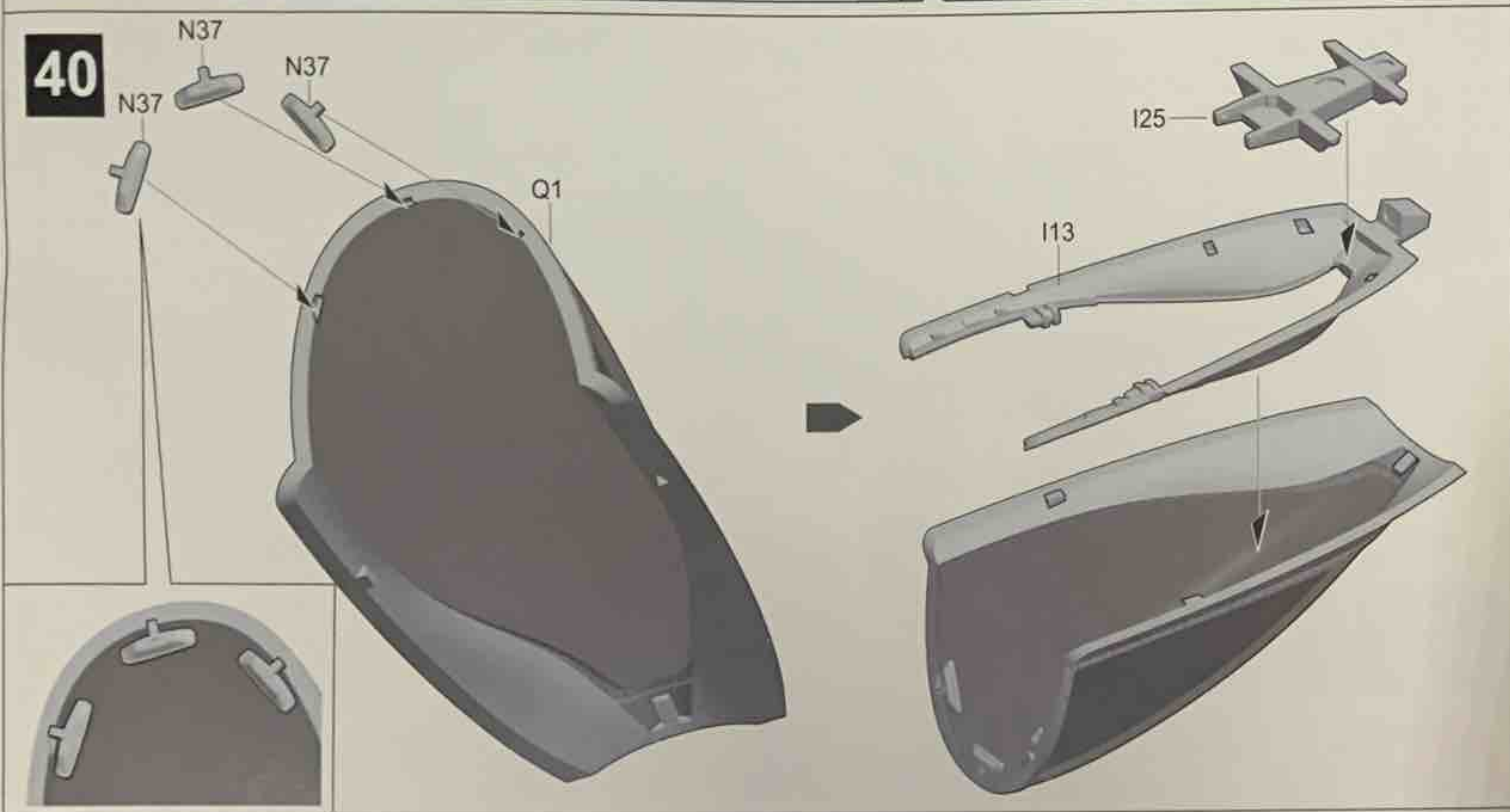
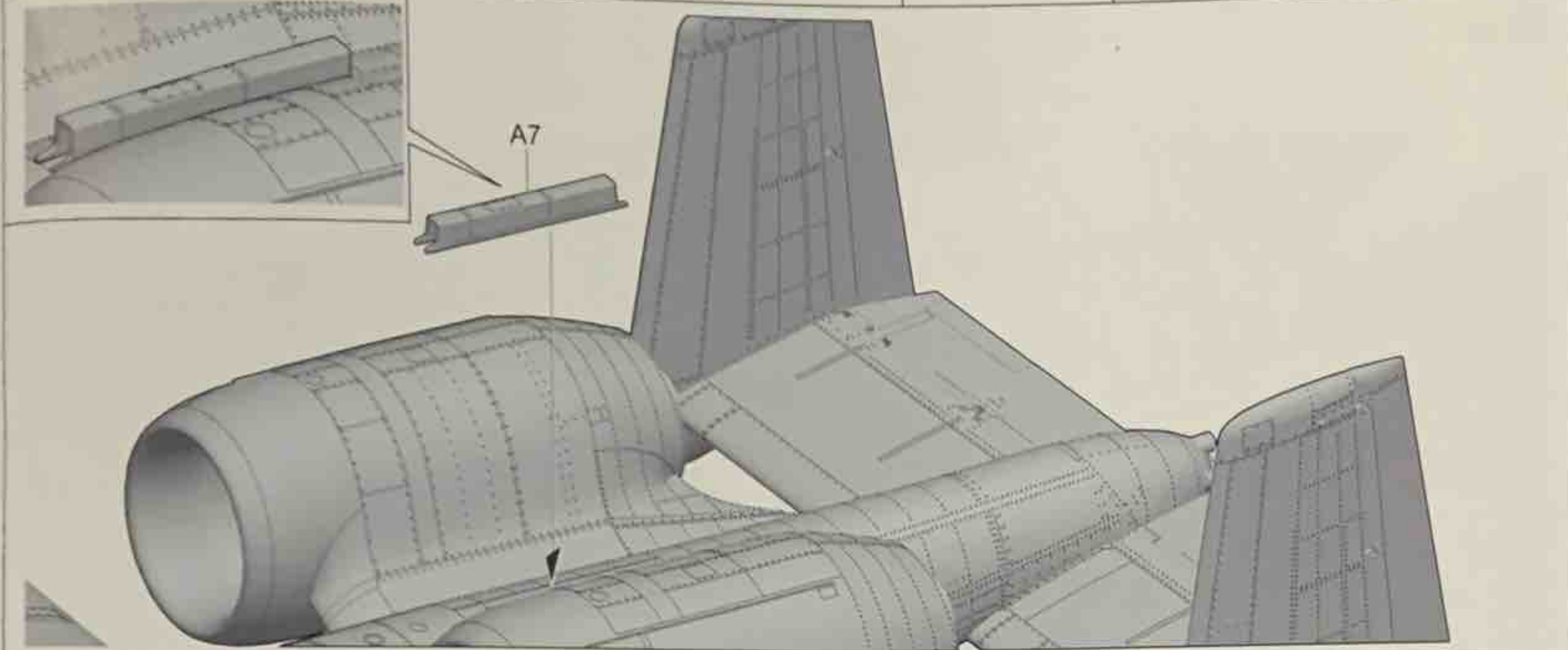
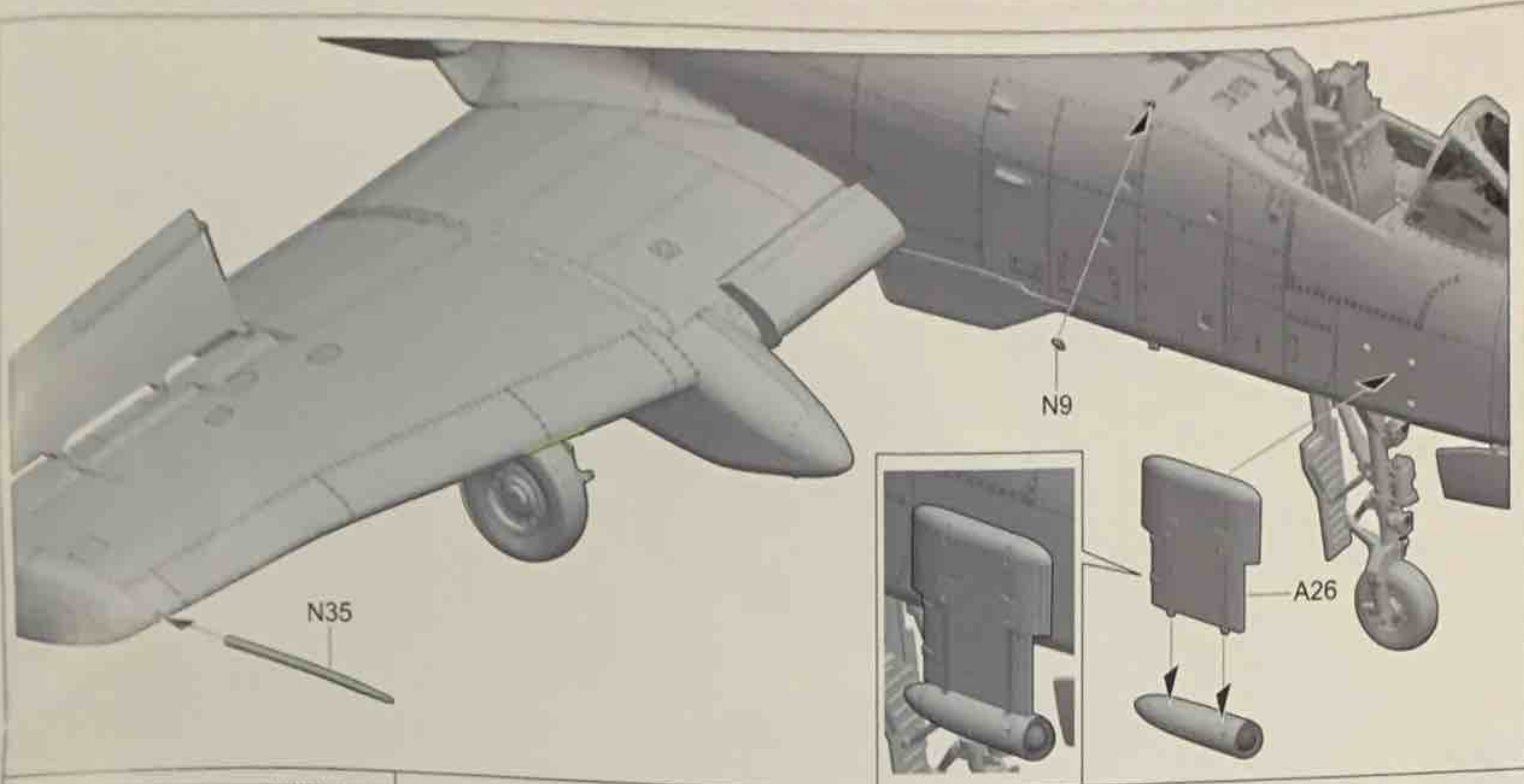

40

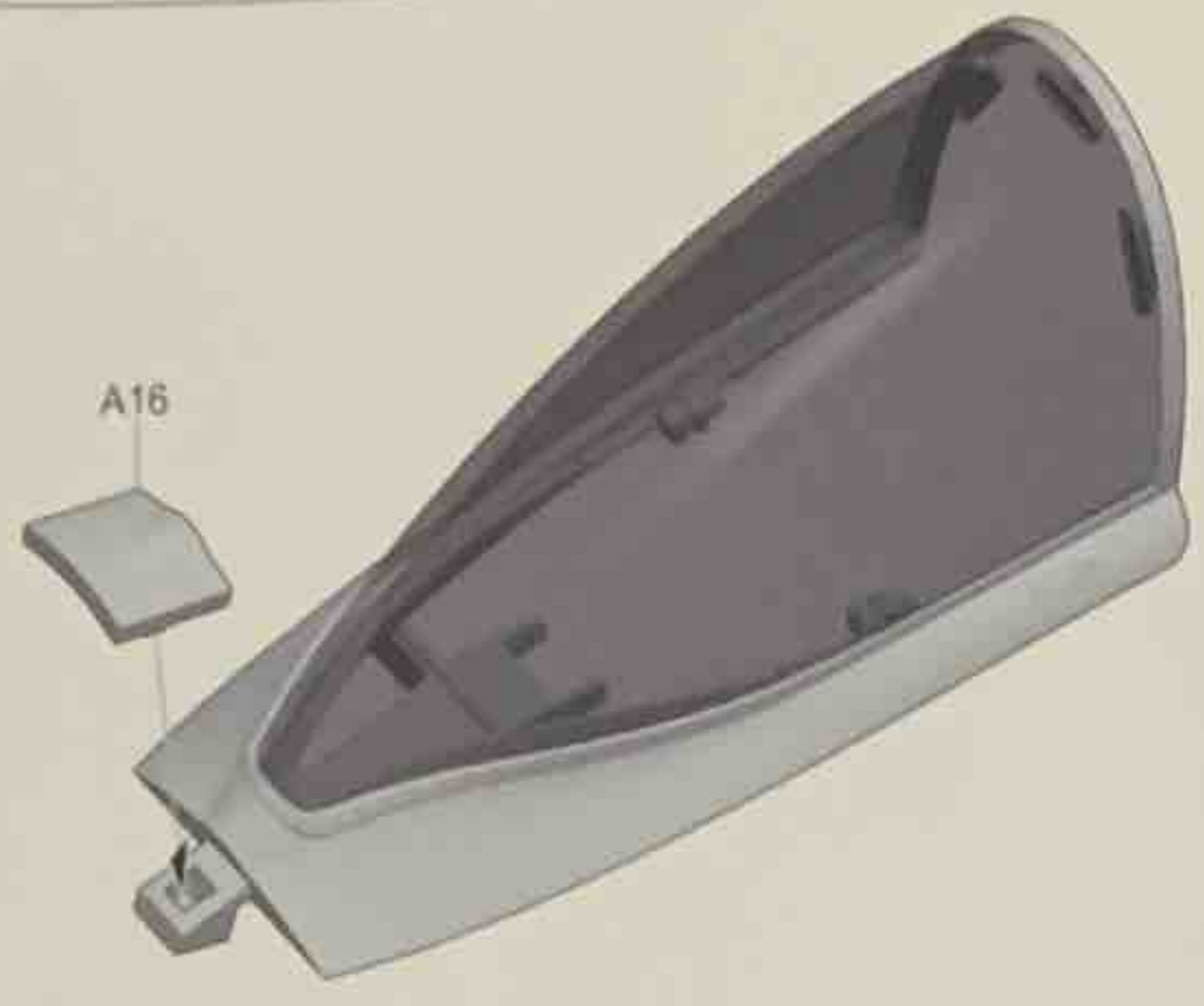

Open state
打开状态

41



Painting scheme B for use A54/A86
涂装B使用水贴A54/A86
Painting scheme C for use A18
涂装C使用水贴A18
Painting scheme D for use A7
涂装D使用水贴A7
Painting scheme E for use A52
涂装E使用水贴A52

Open state
打开状态

42

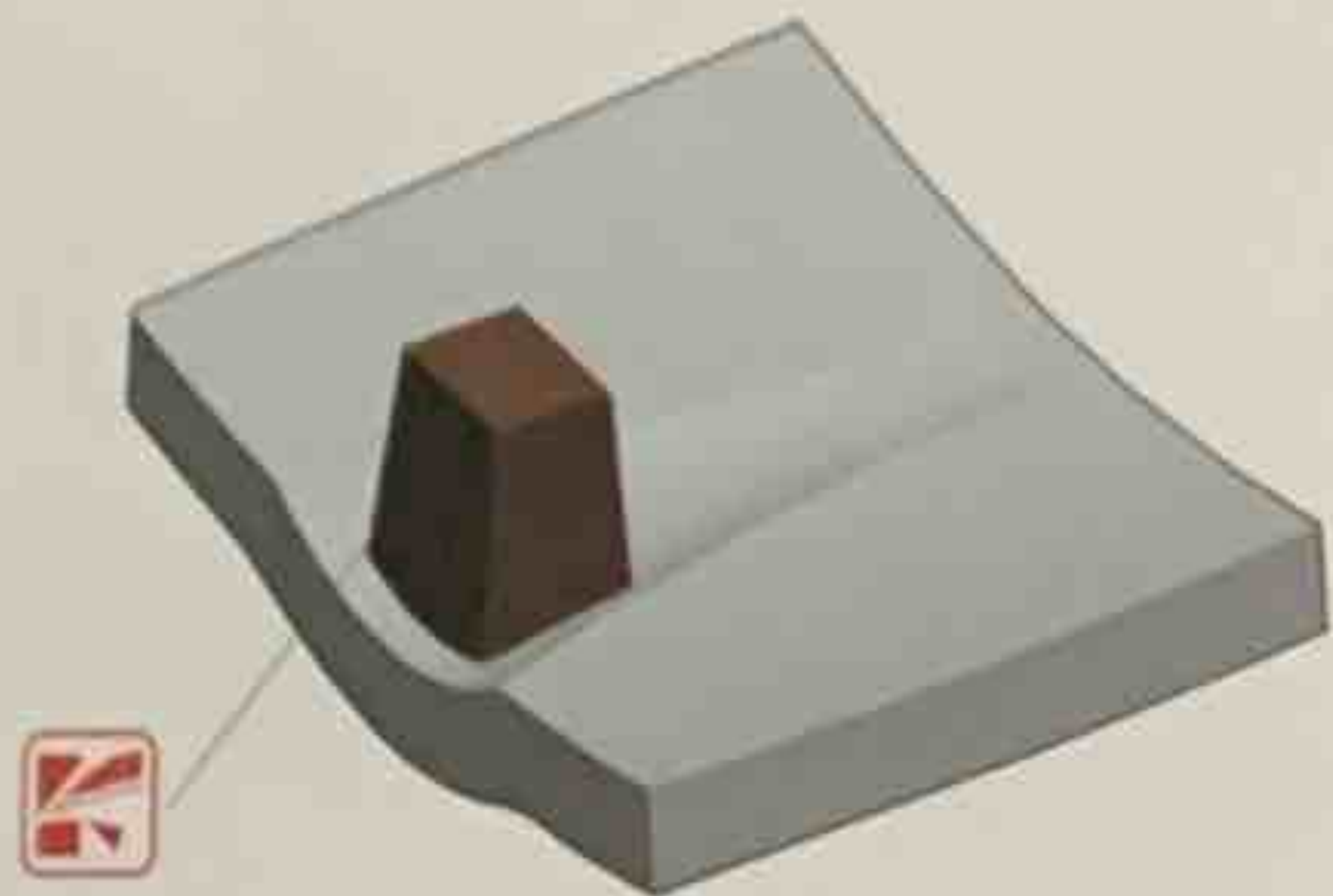

A16

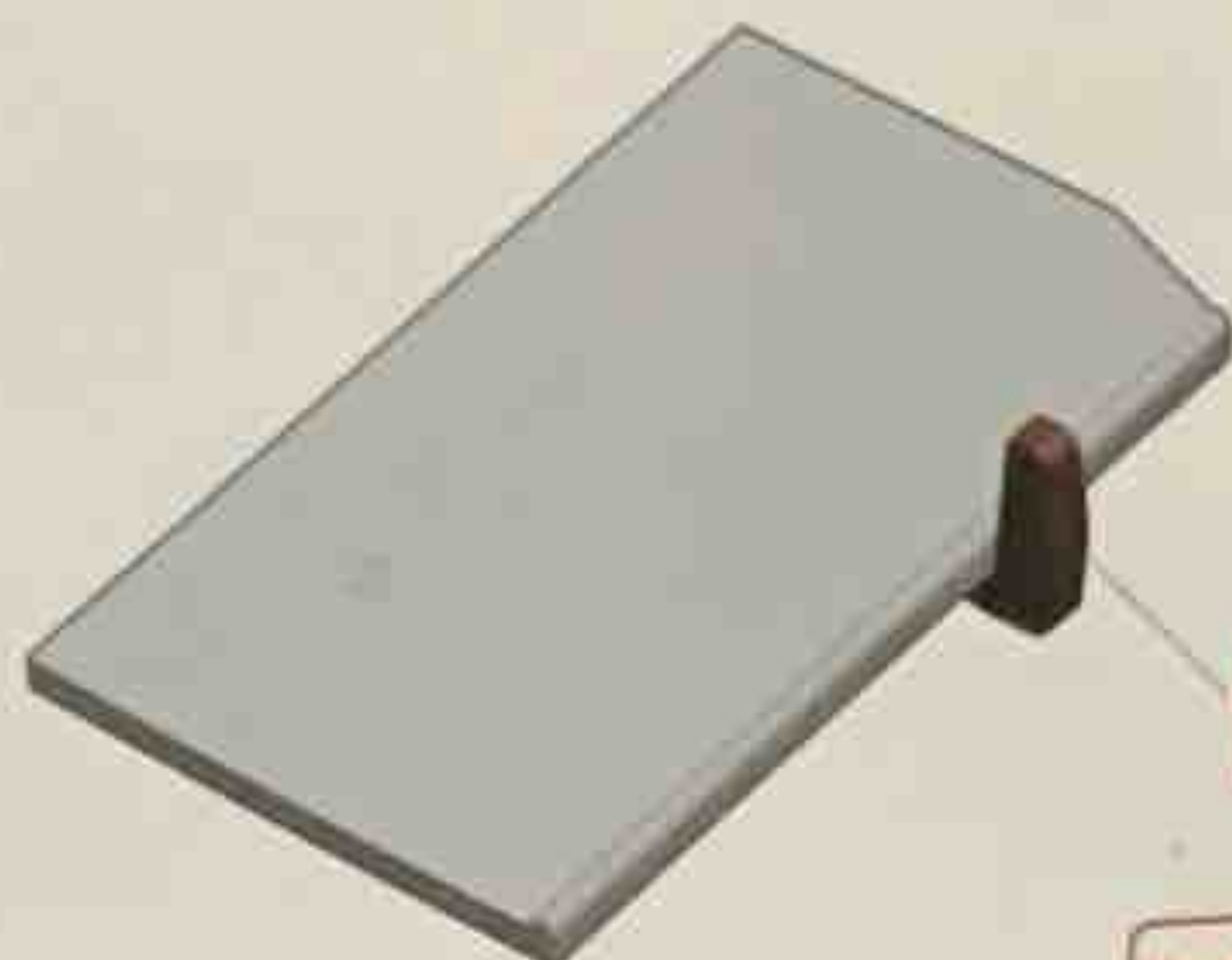

A14

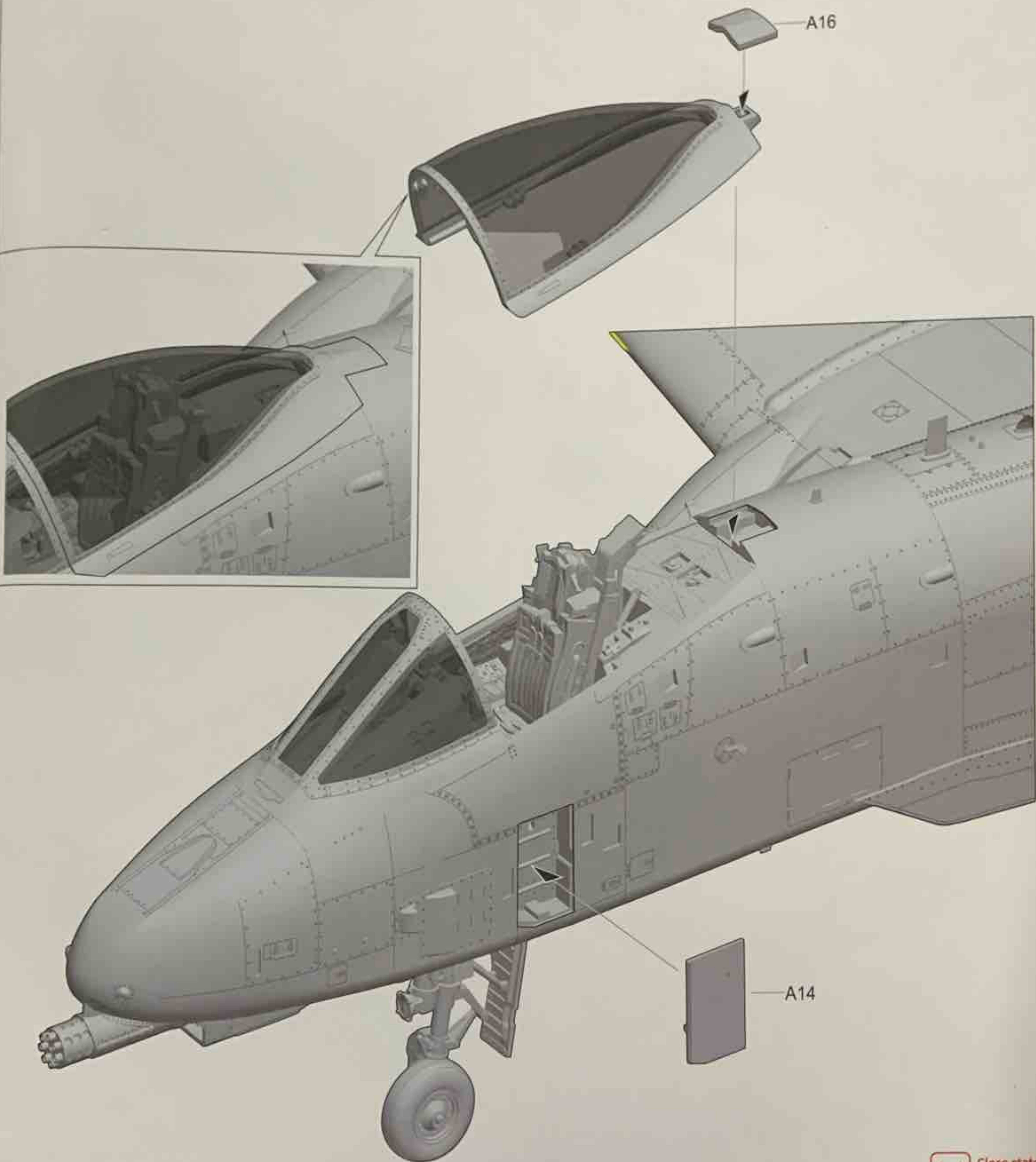

A16

A14



43

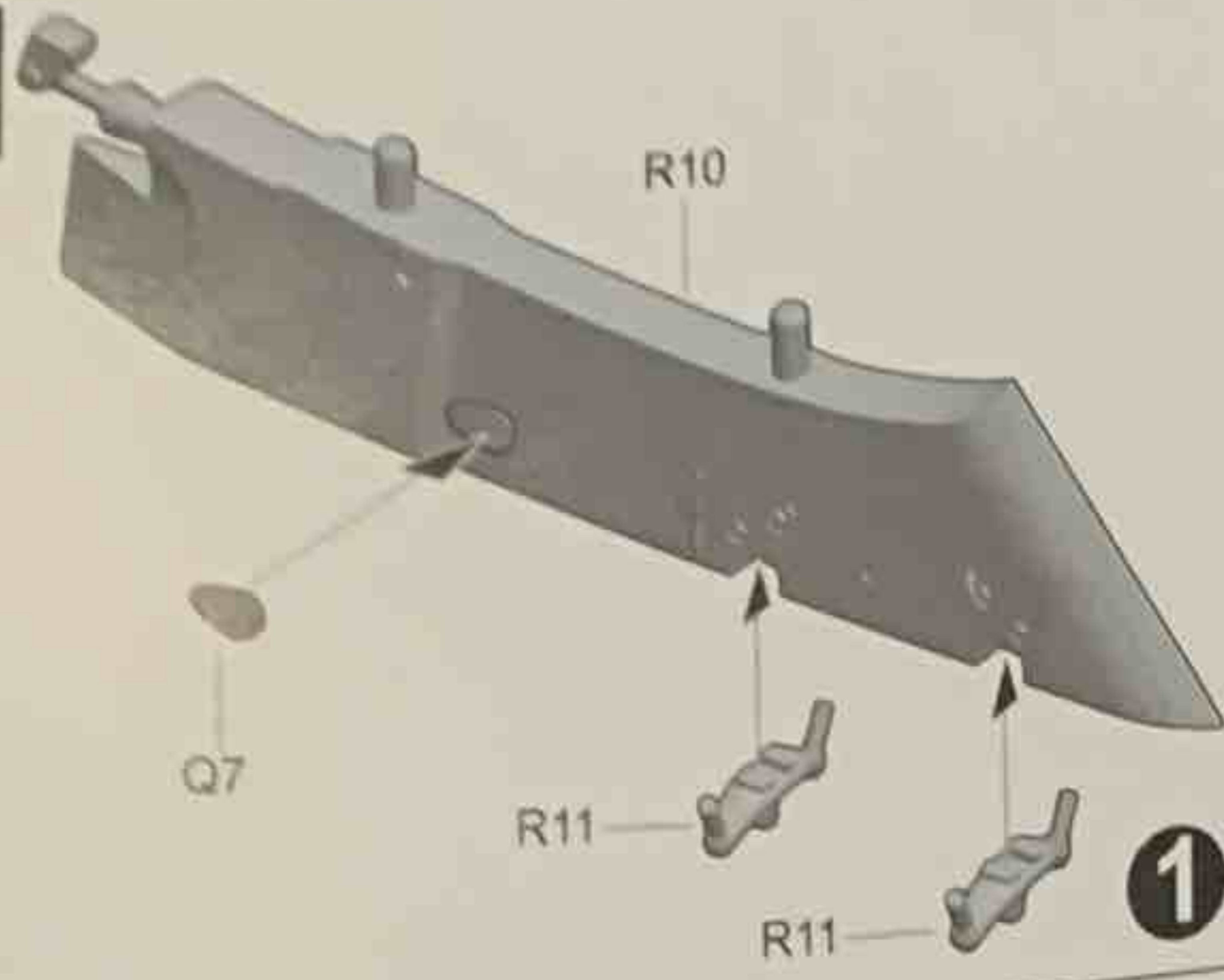

1

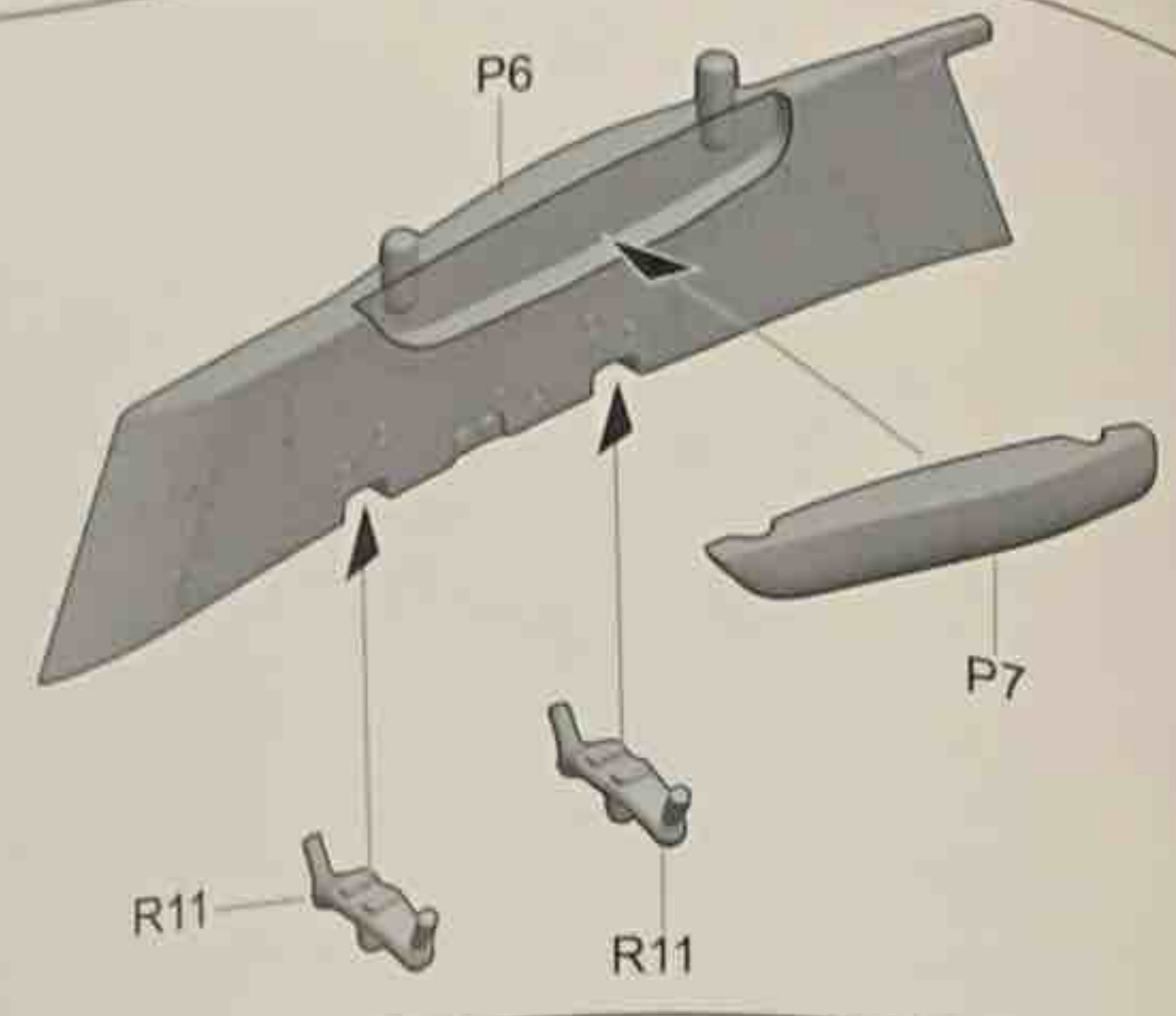

2

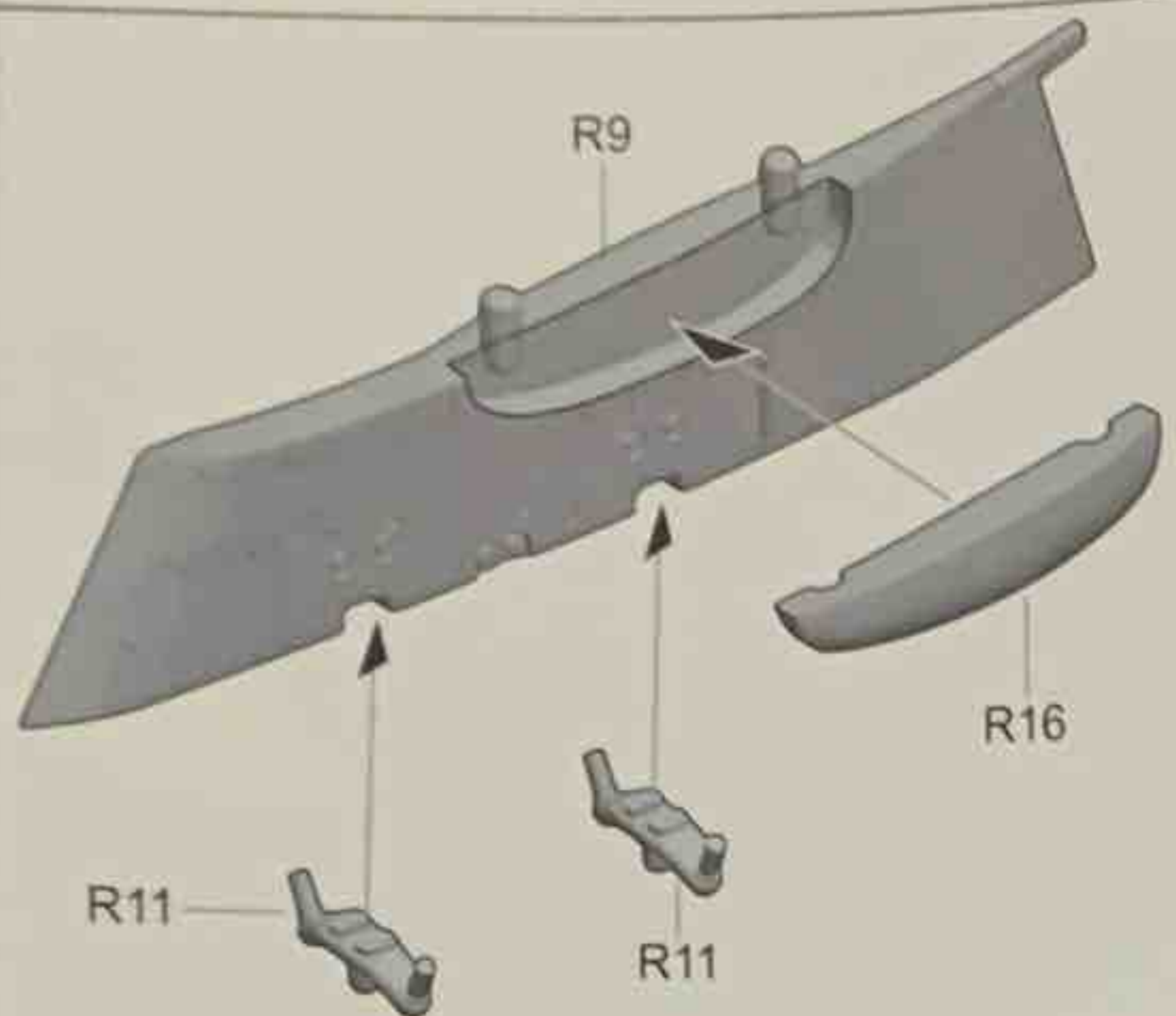

3

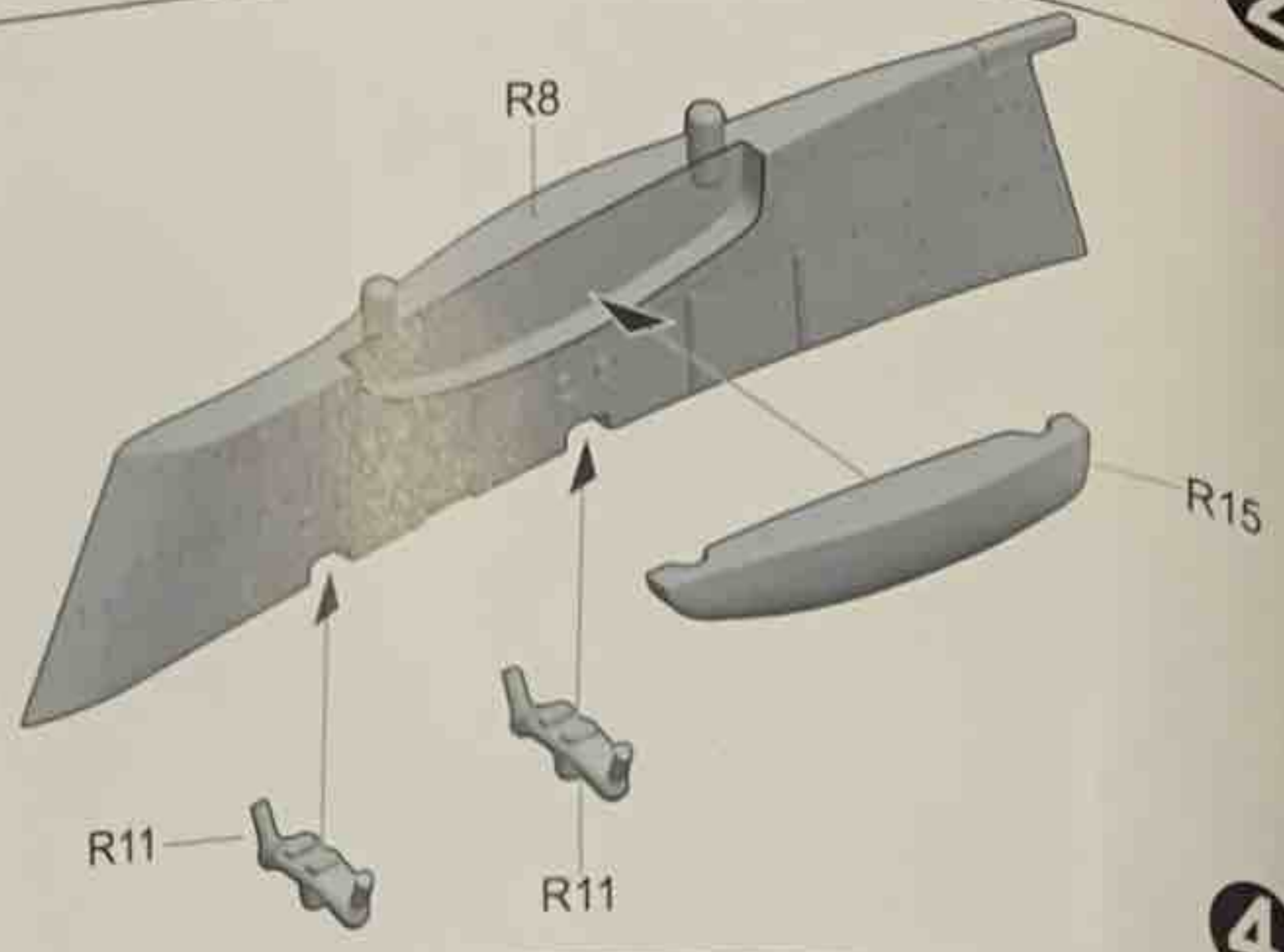

4

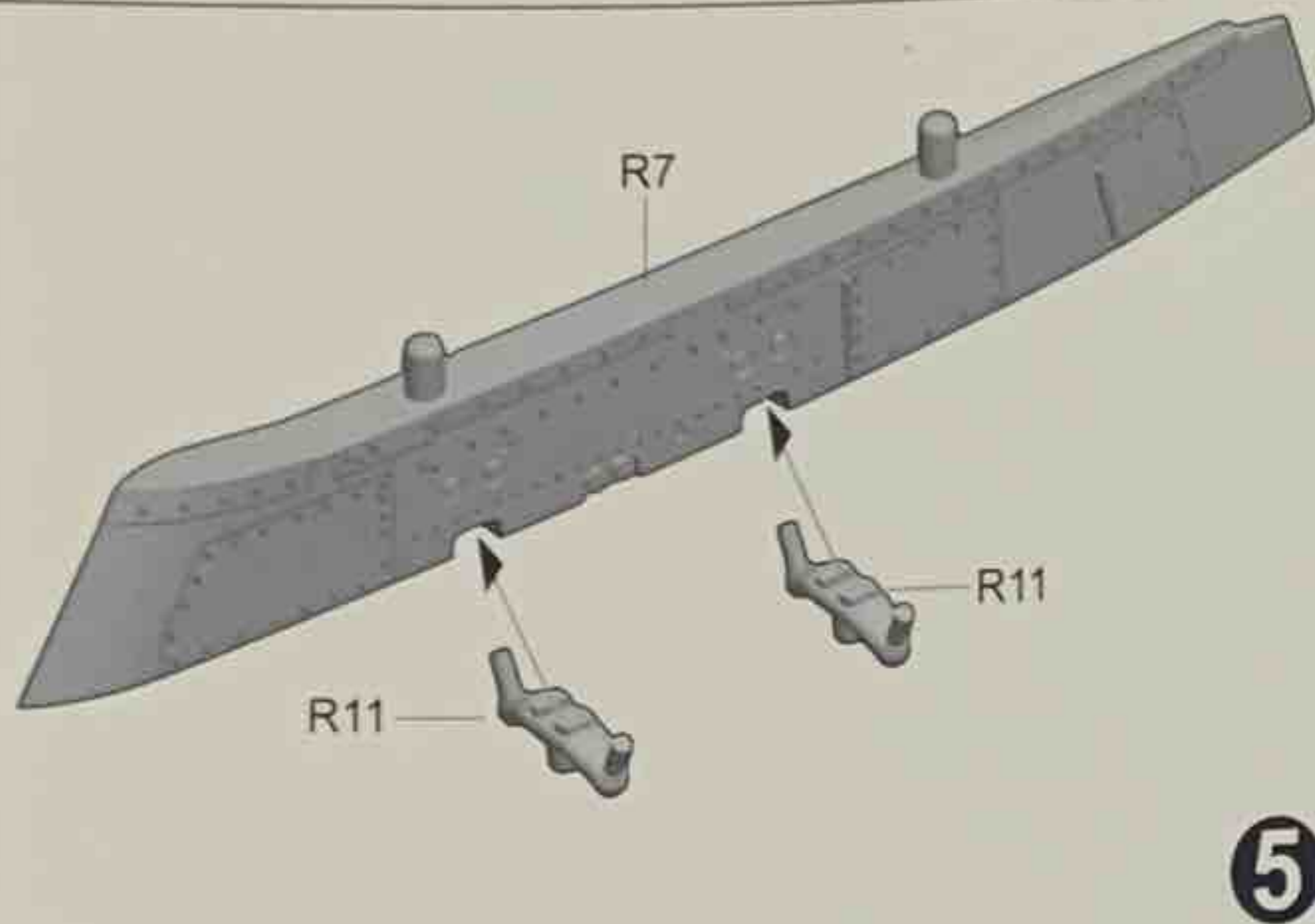

5

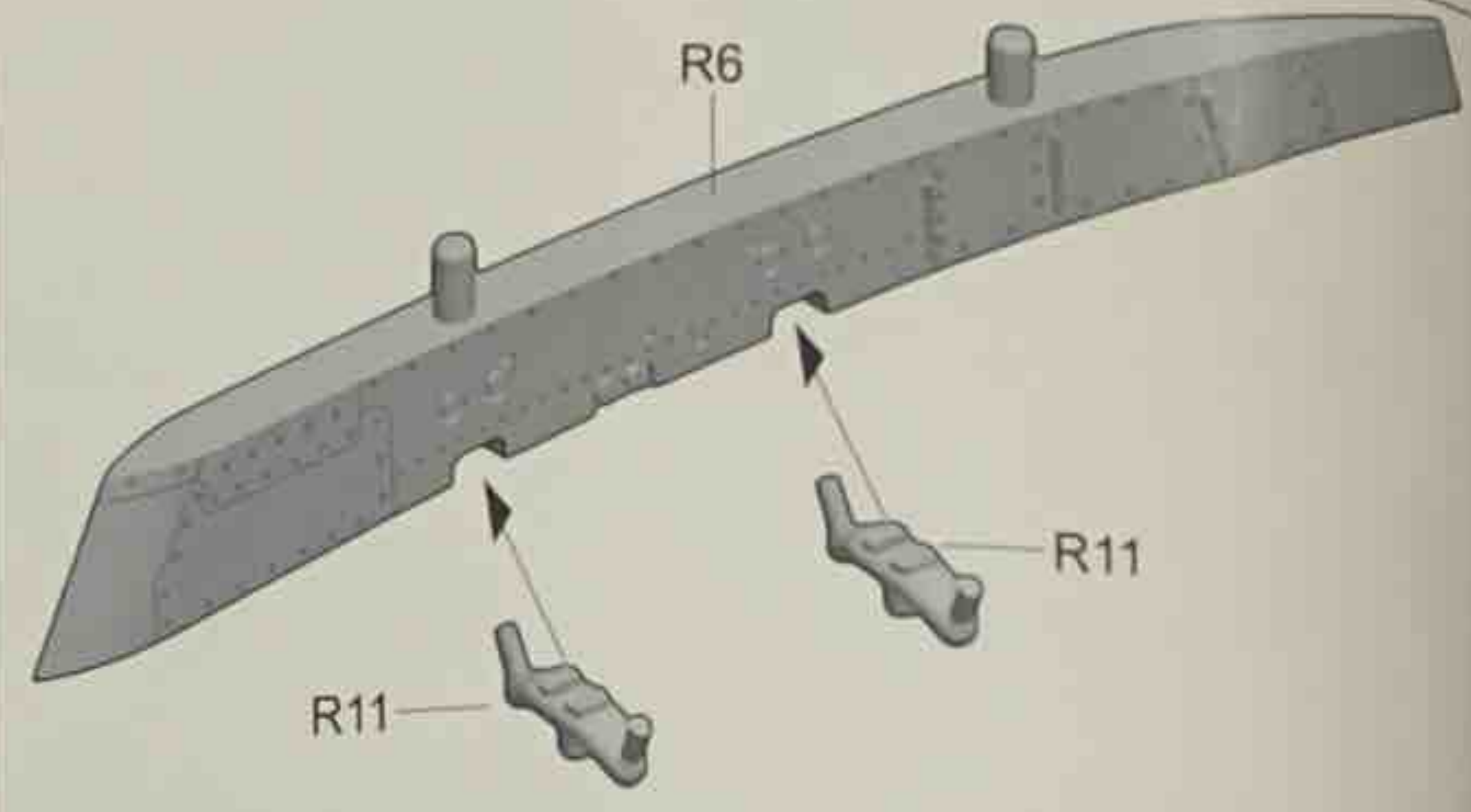

6

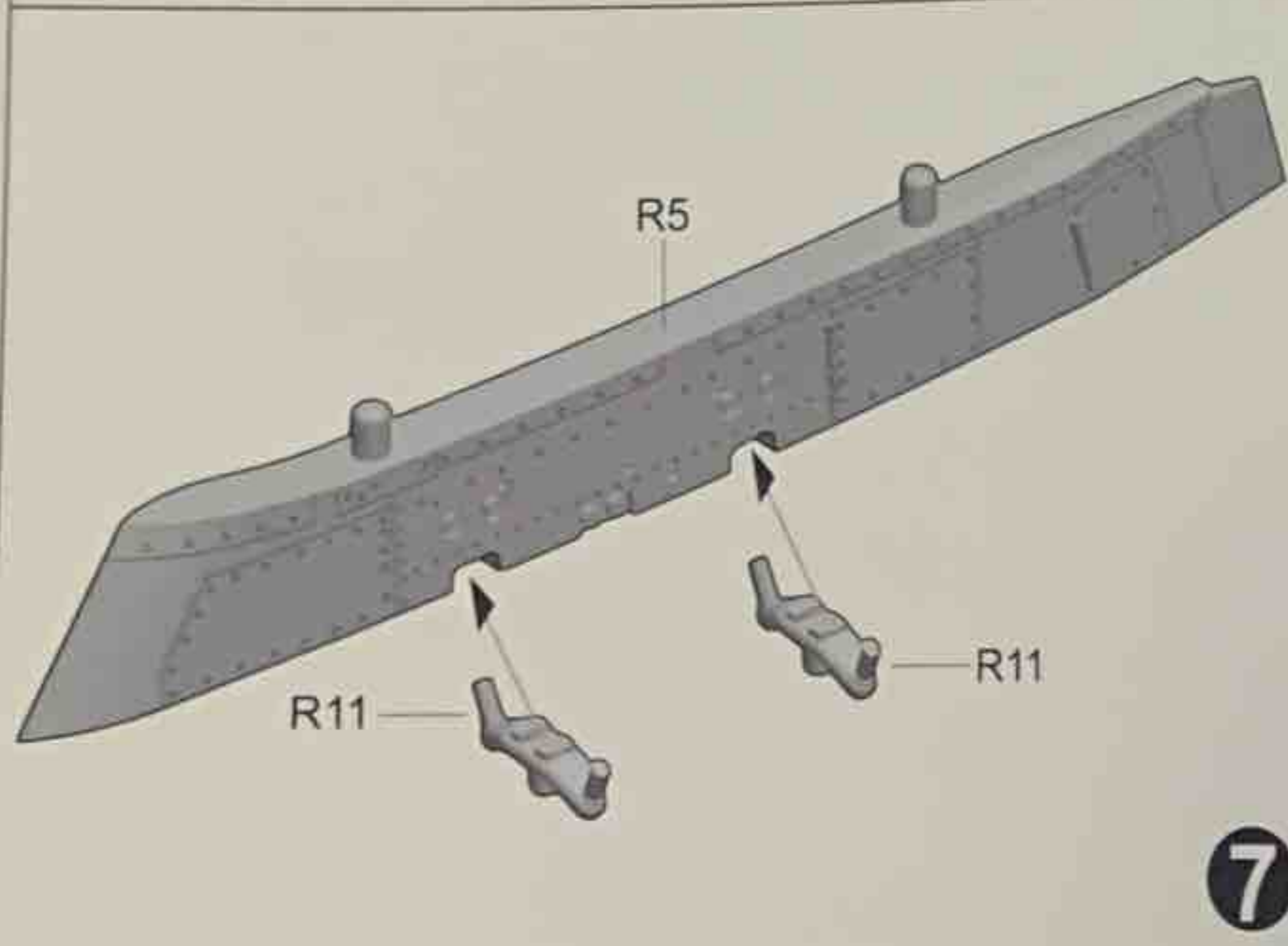

7

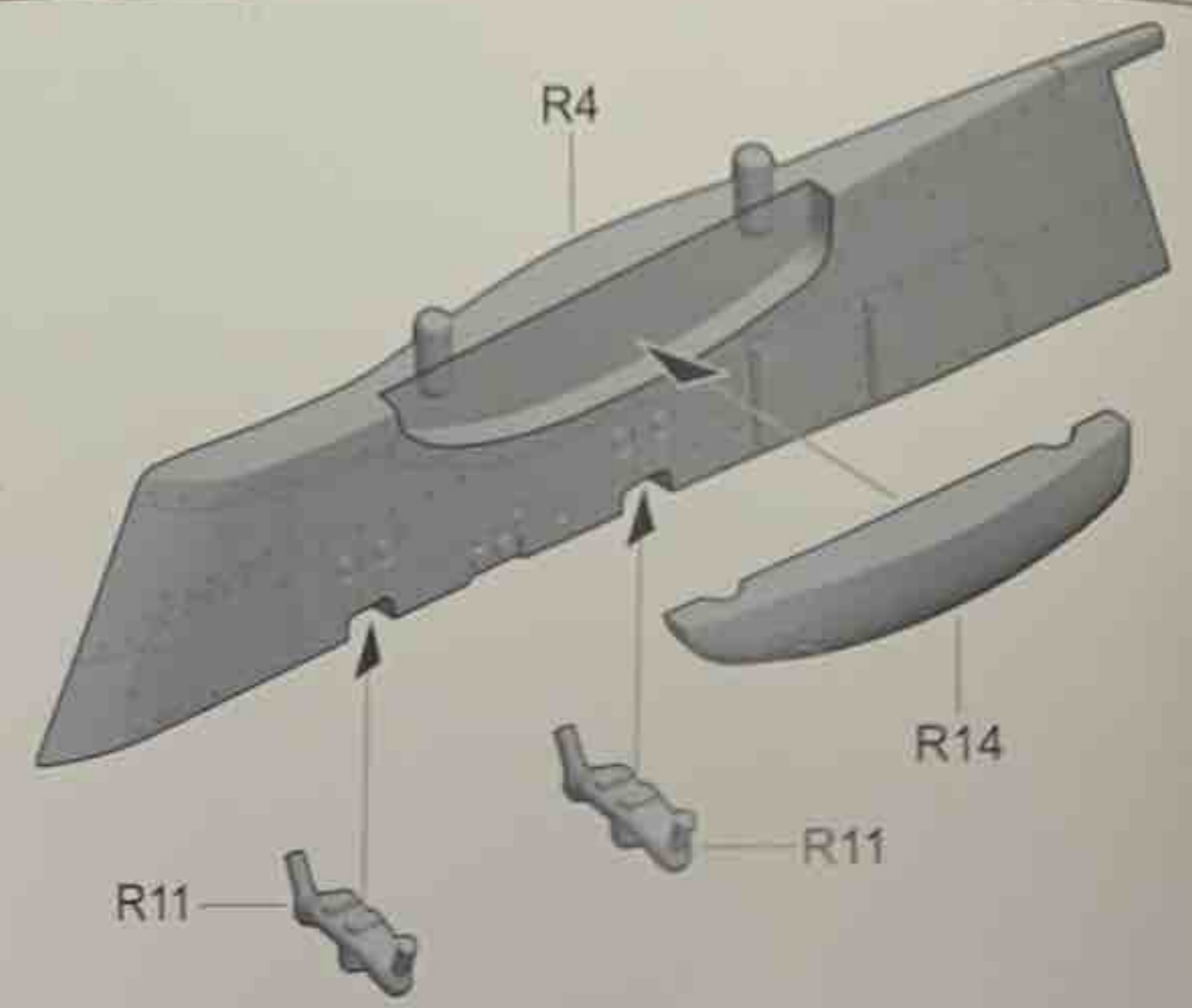

8

43

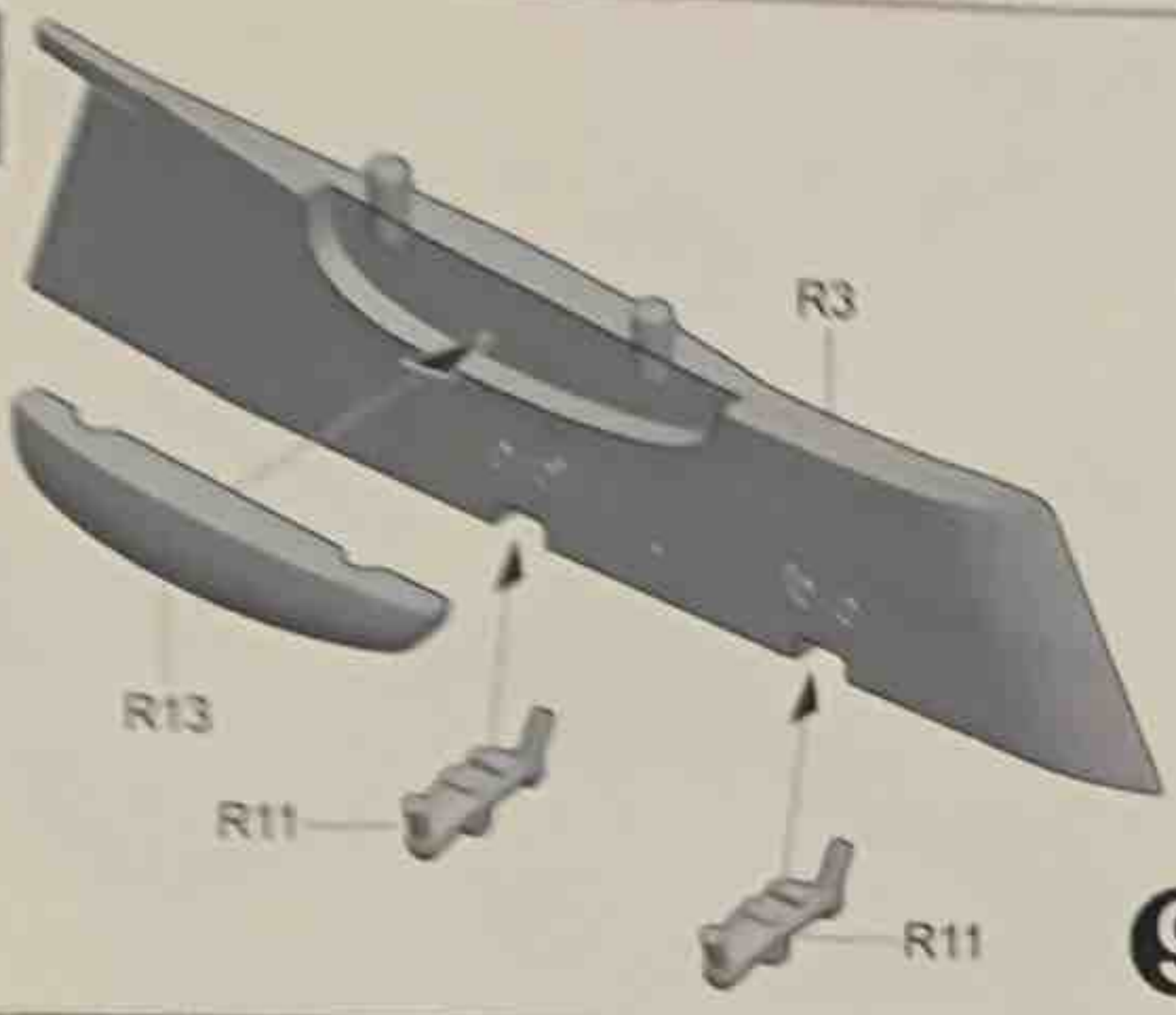

9

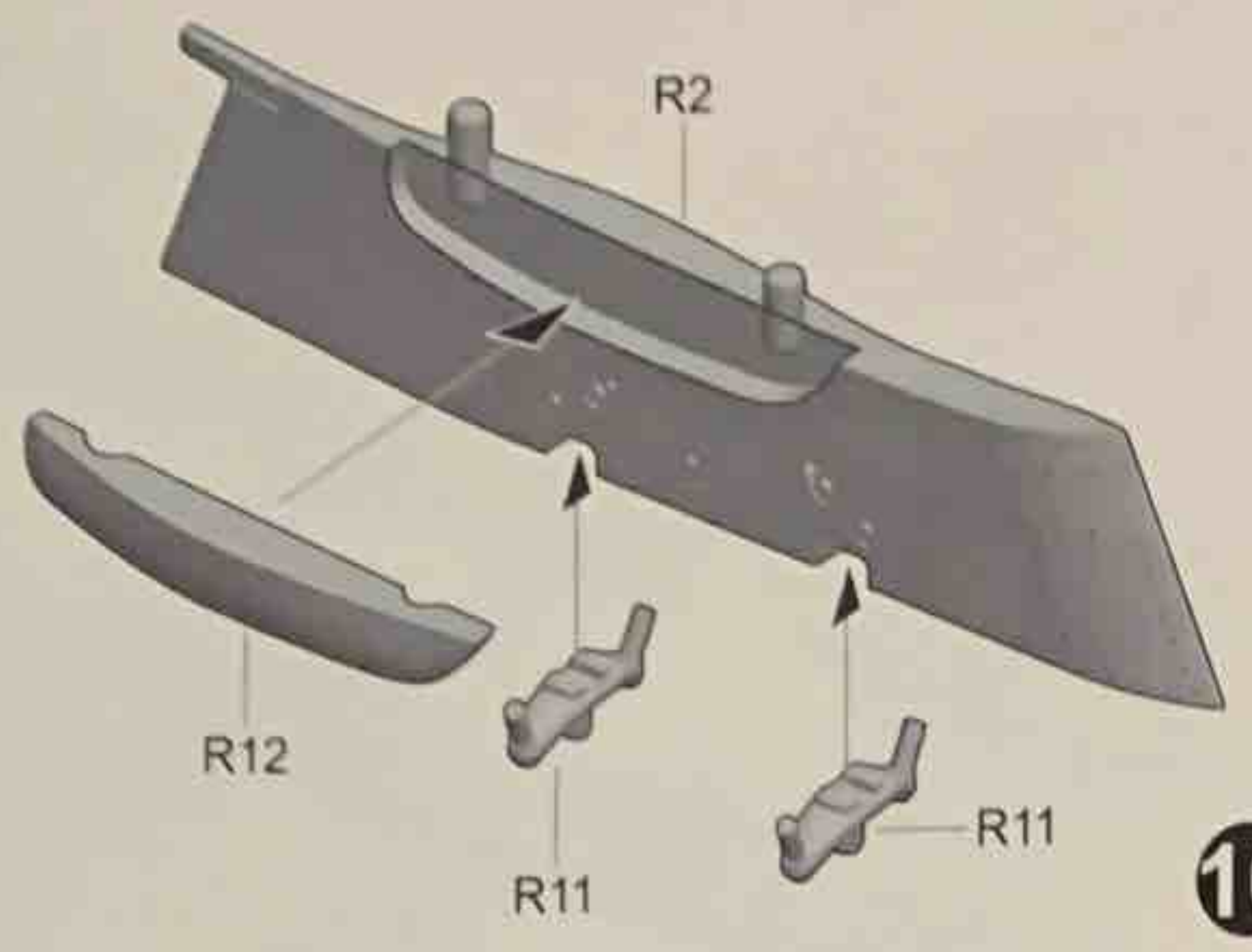

10

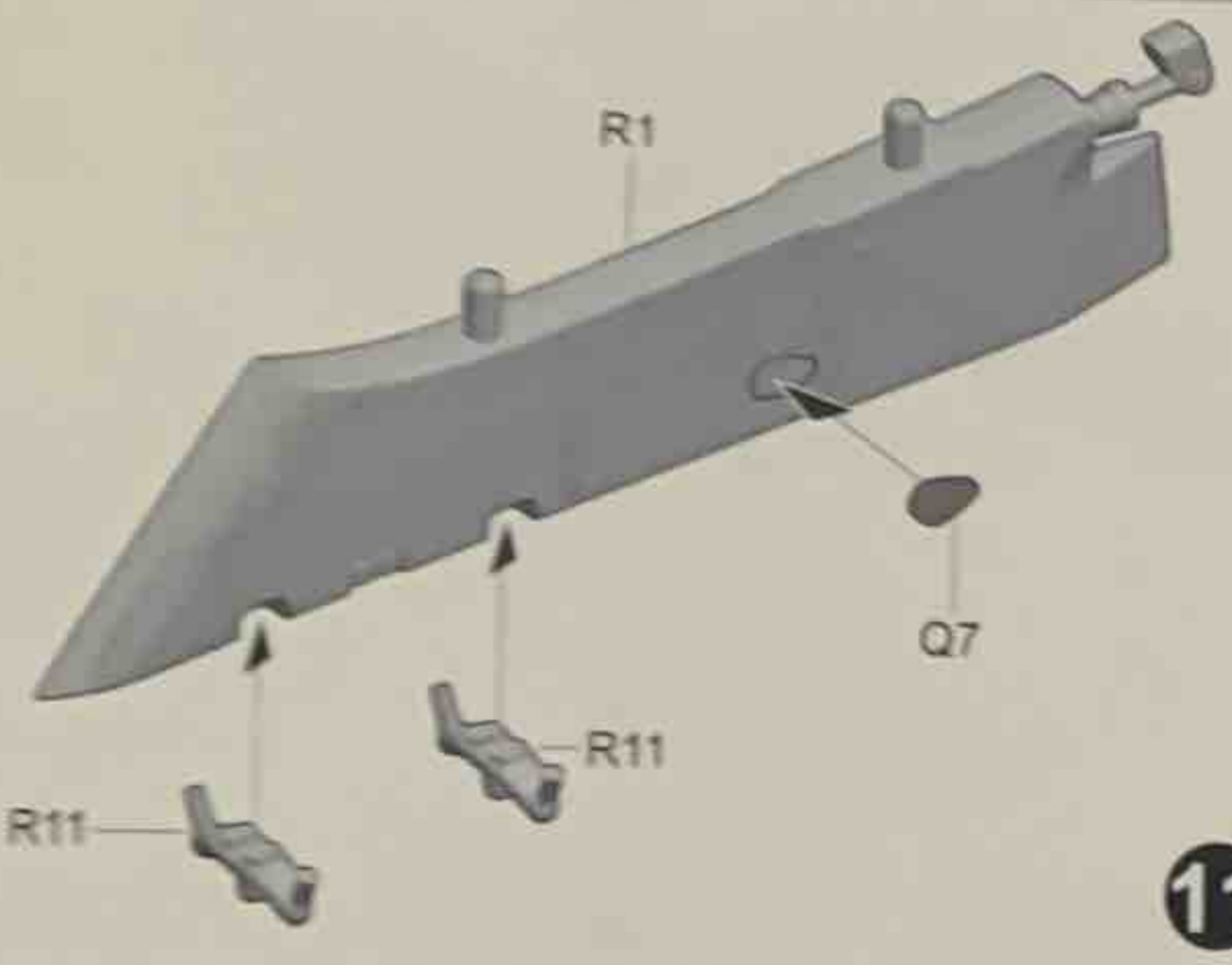

11

MK83 Bomb
MK83 炸弹

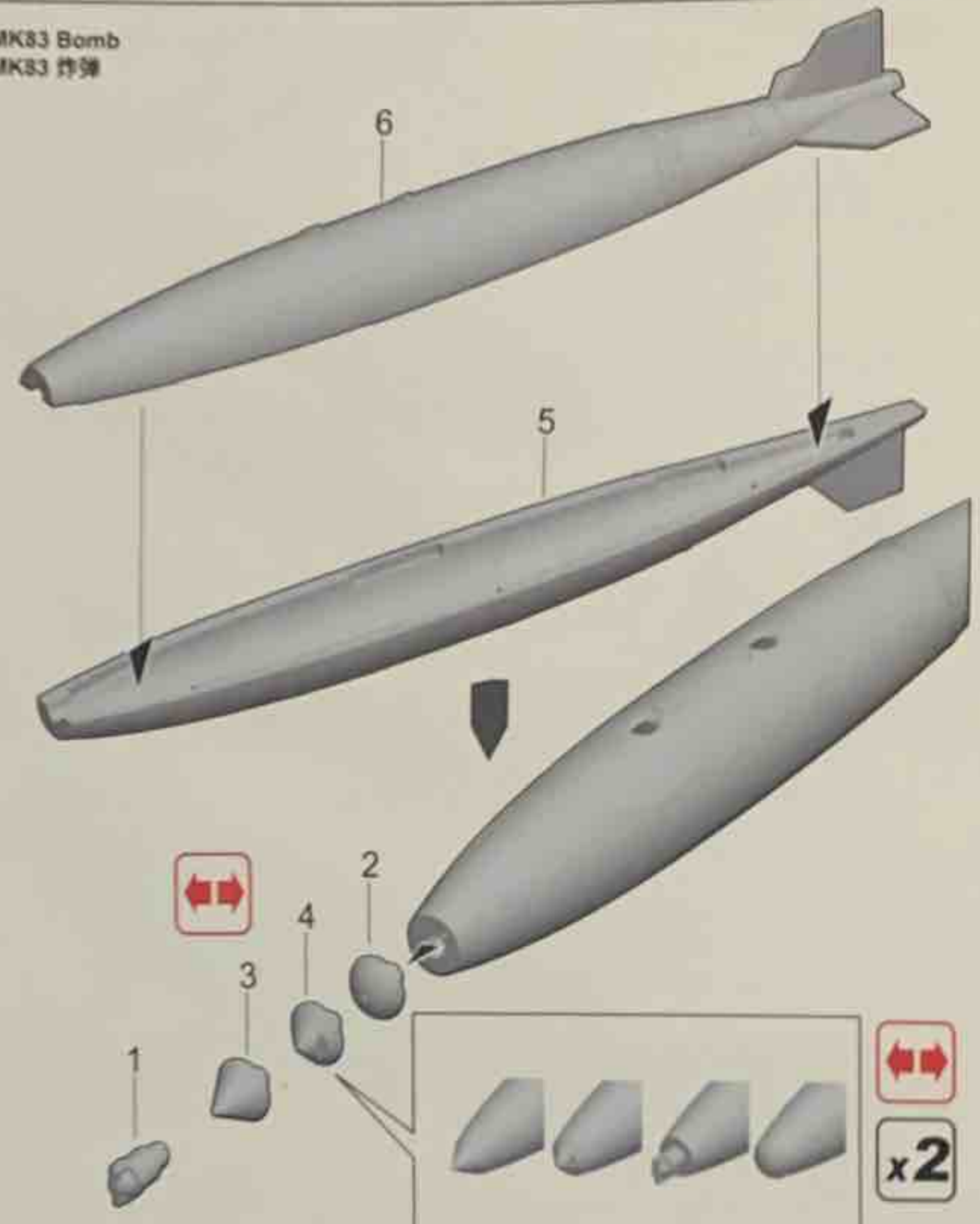

AGM-85 Haverick
AGM-85 空地导弹

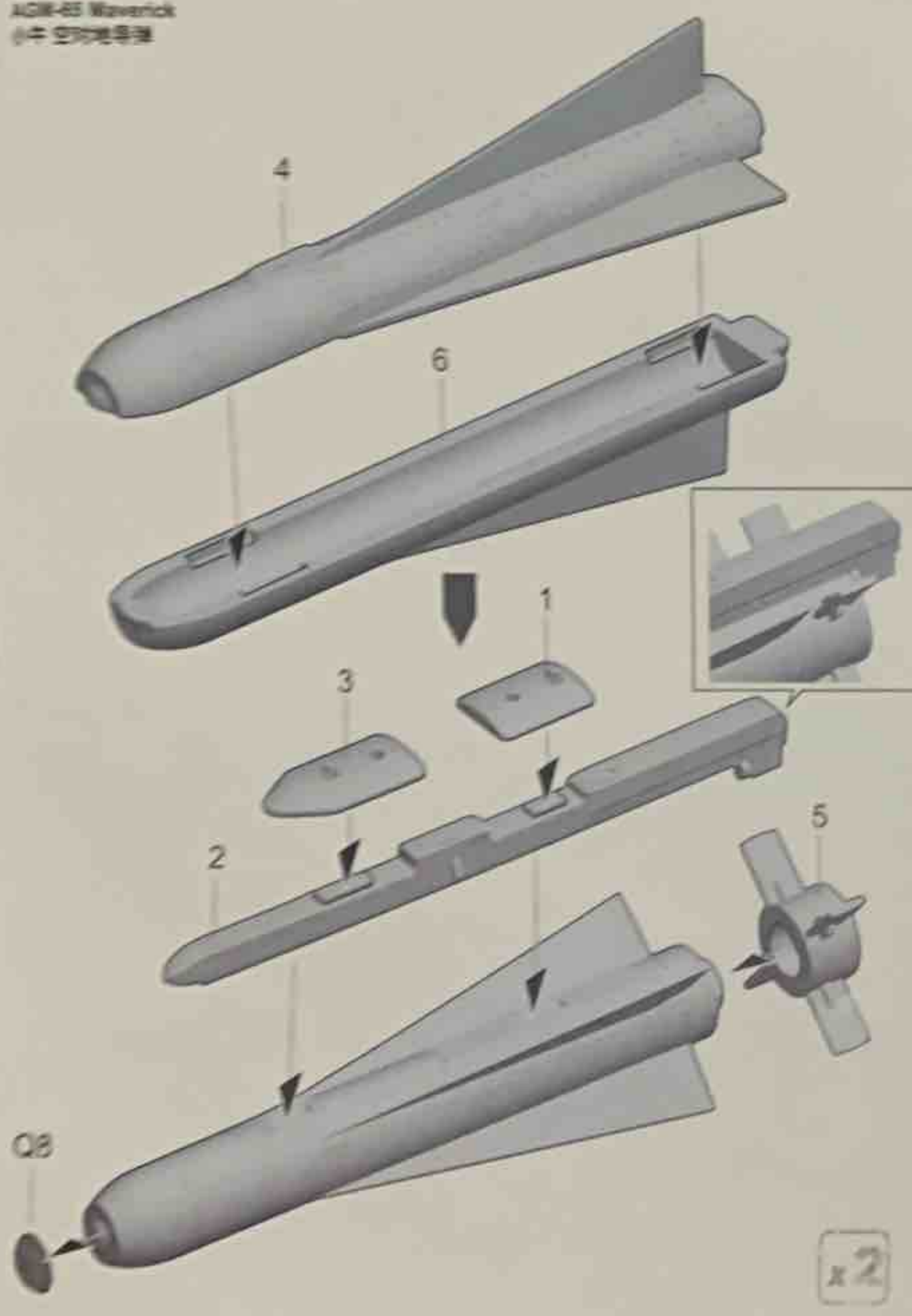

x2

LAU-131 Launcher
LAU-131 火箭巢



x2

A-10 TANK
A-10 副油箱

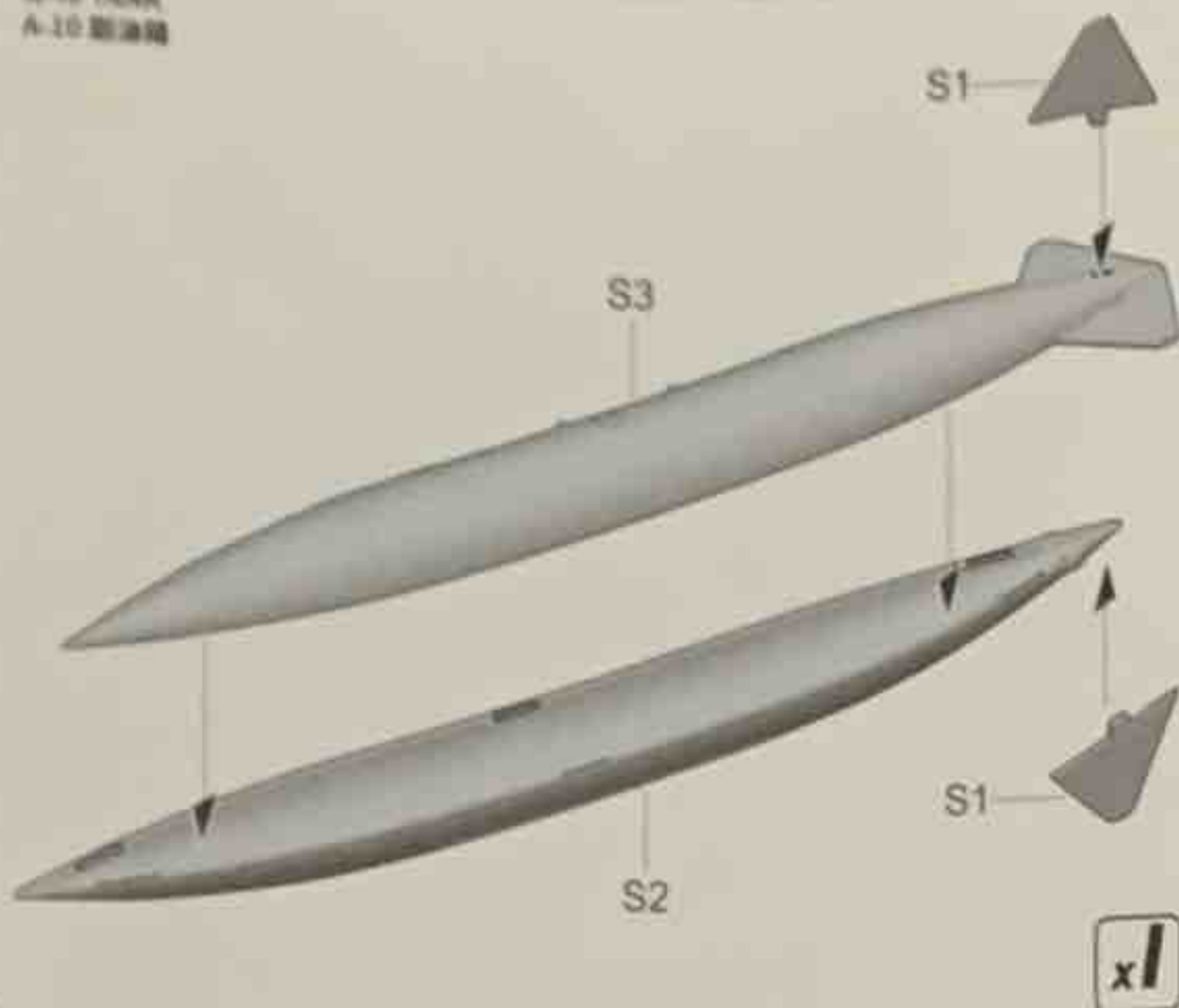

Twin AIM-9L missile
双联 AIM-9L 导弹

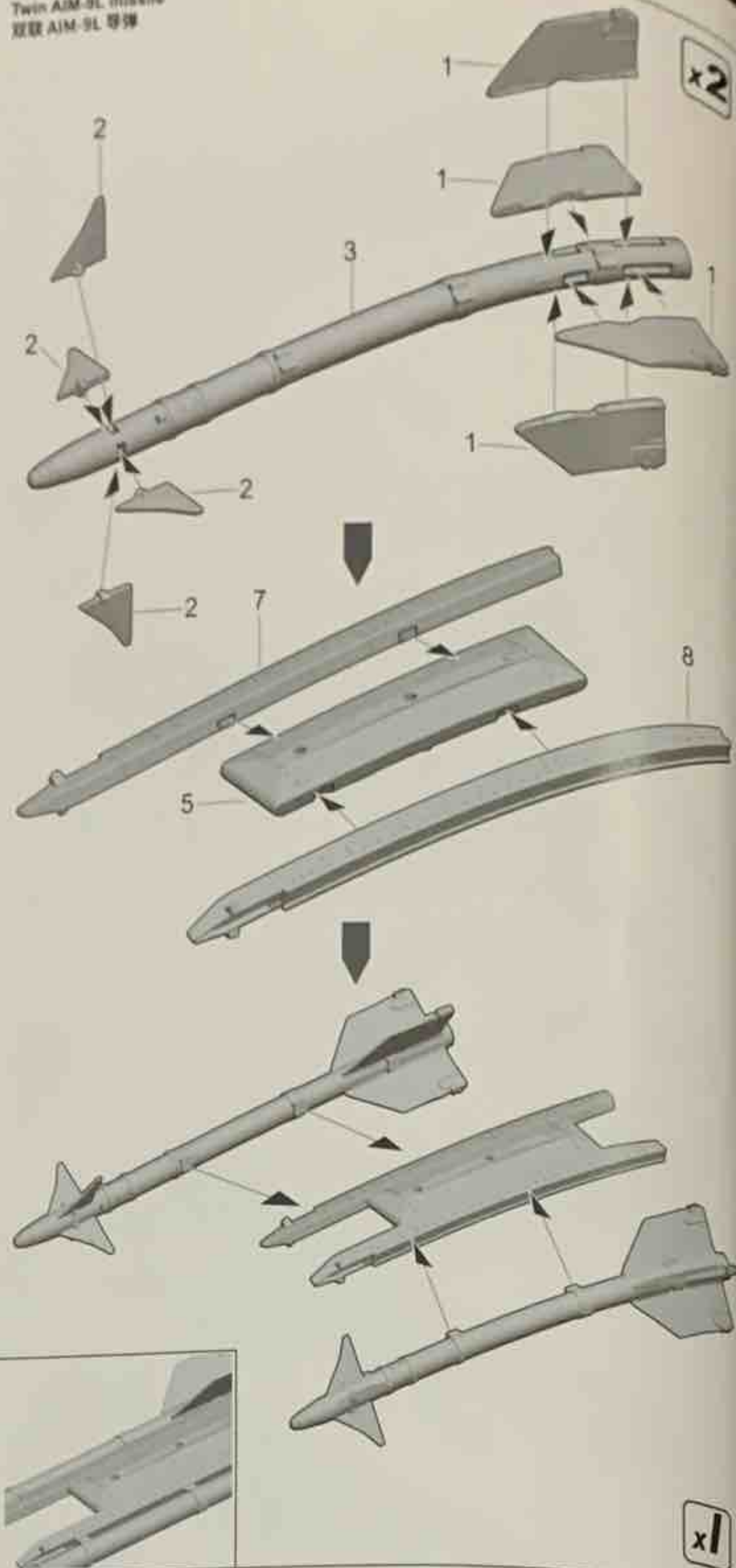

ALQ-131 ECM POD
ALQ-131 电子对抗(ECM)吊舱

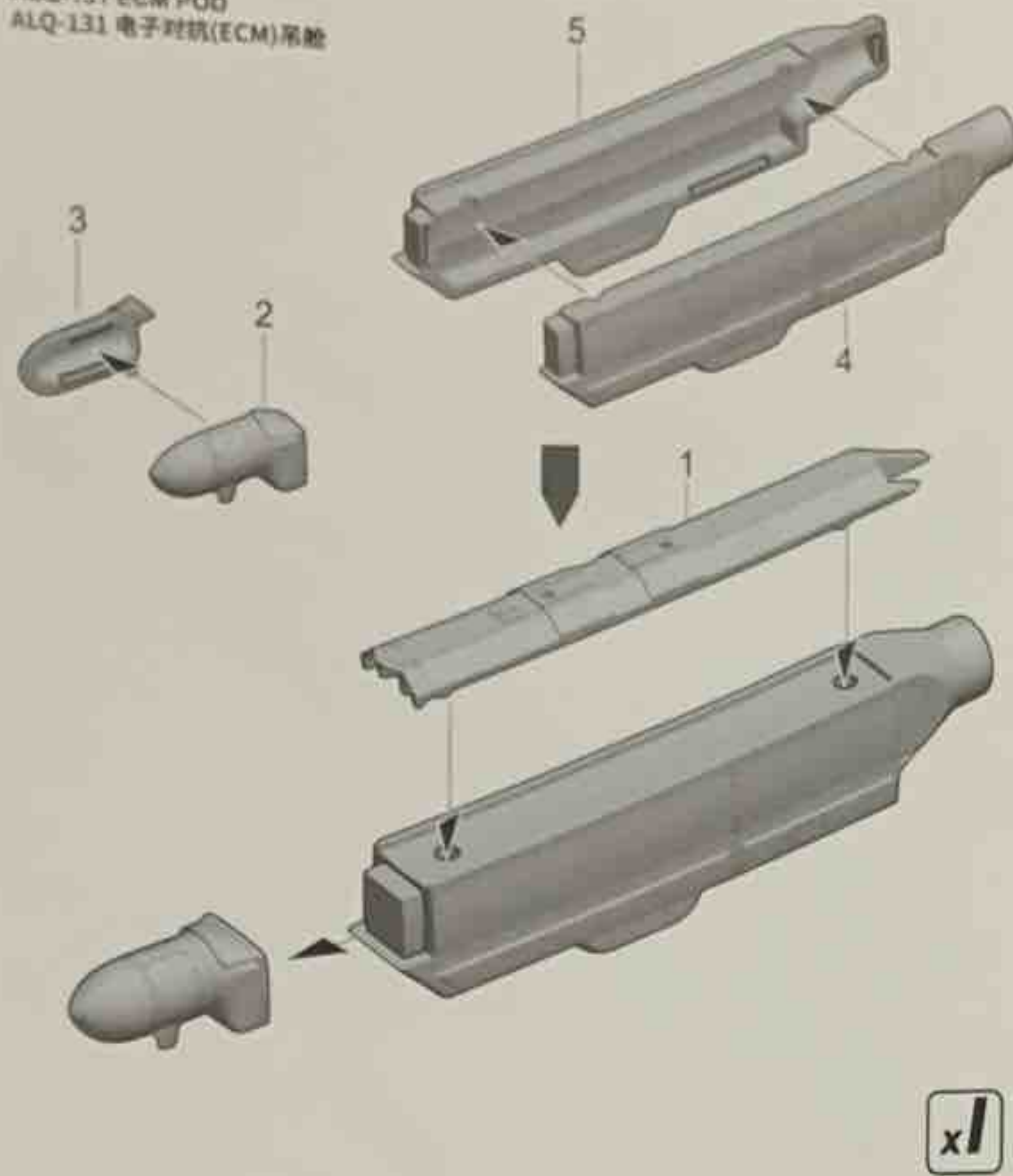

AN/ALQ-184 ECM POD
AN/ALQ-184 自卫式电子对抗(ECM)吊舱

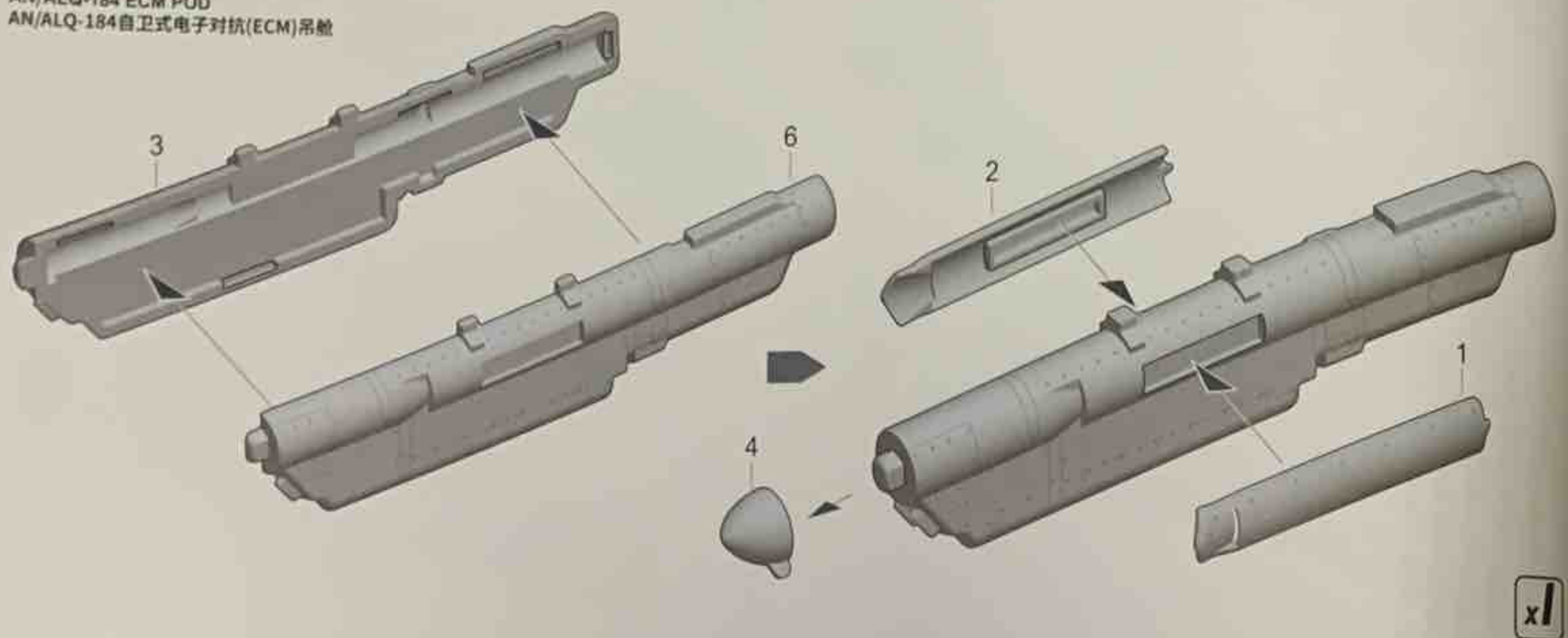

MK82 Bomb
MK82 炸弹

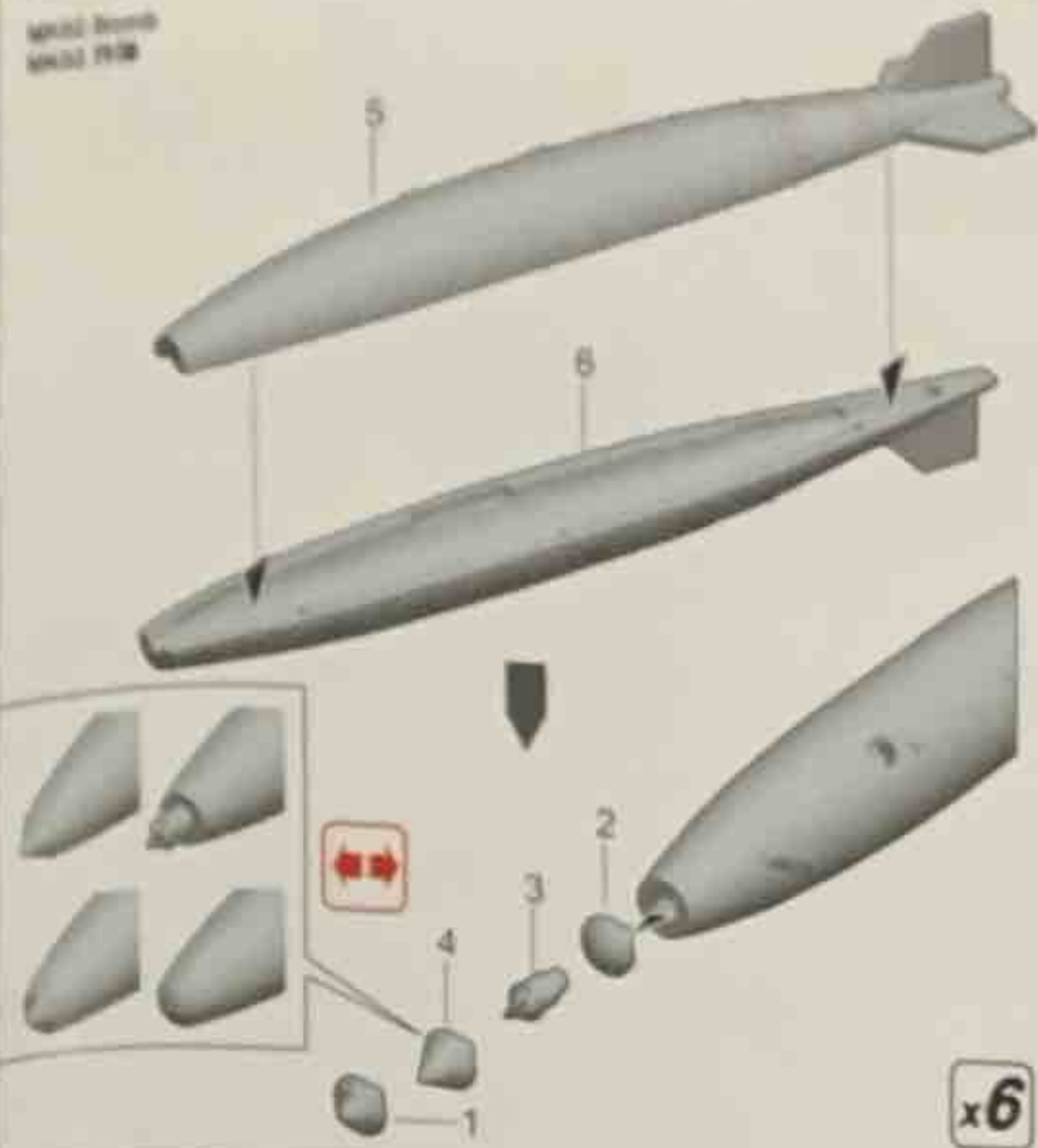

BRU-42 Pylon
BRU-42 挂架

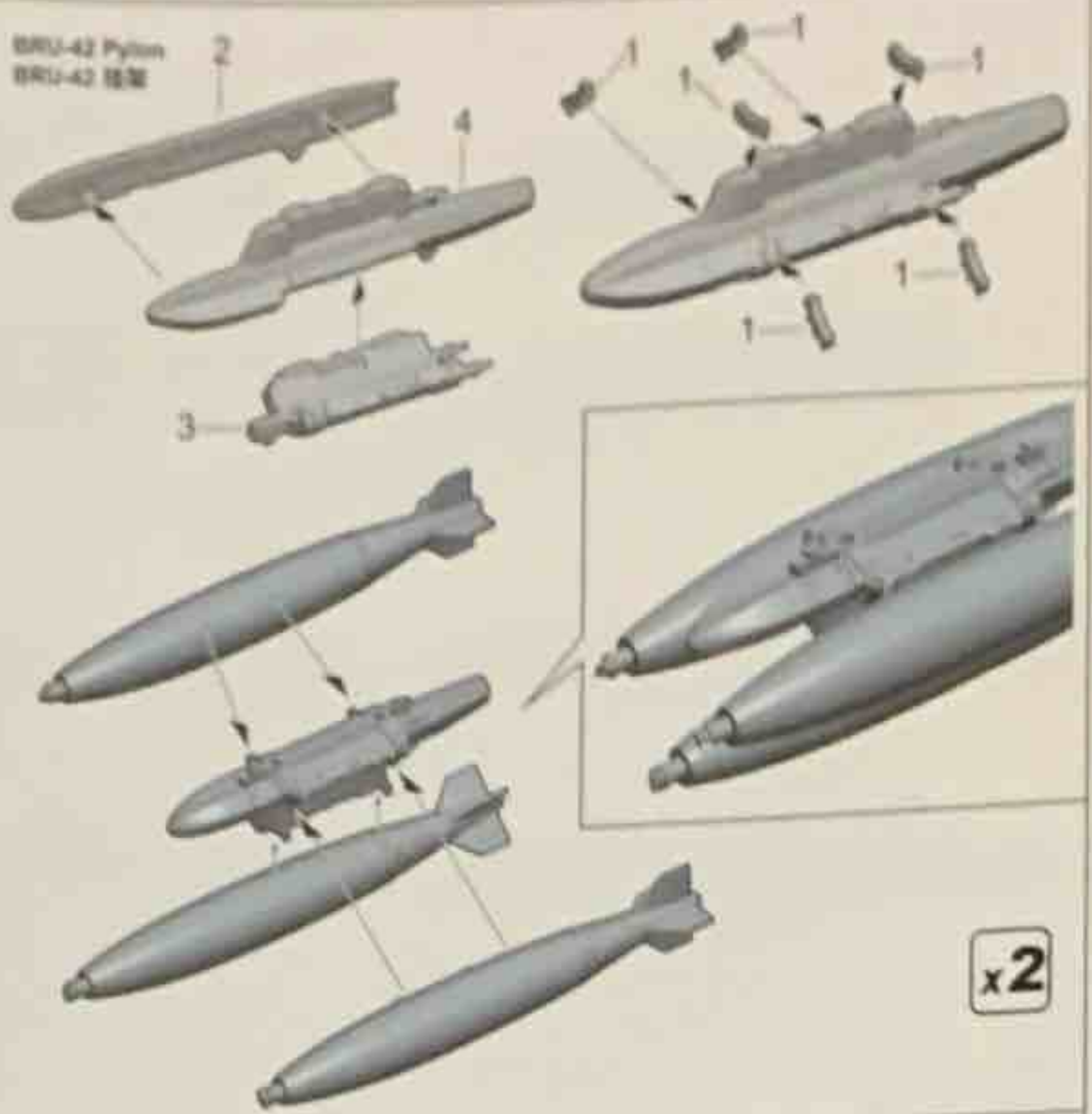

44

AIM-9L Missile
AIM-9L 导弹

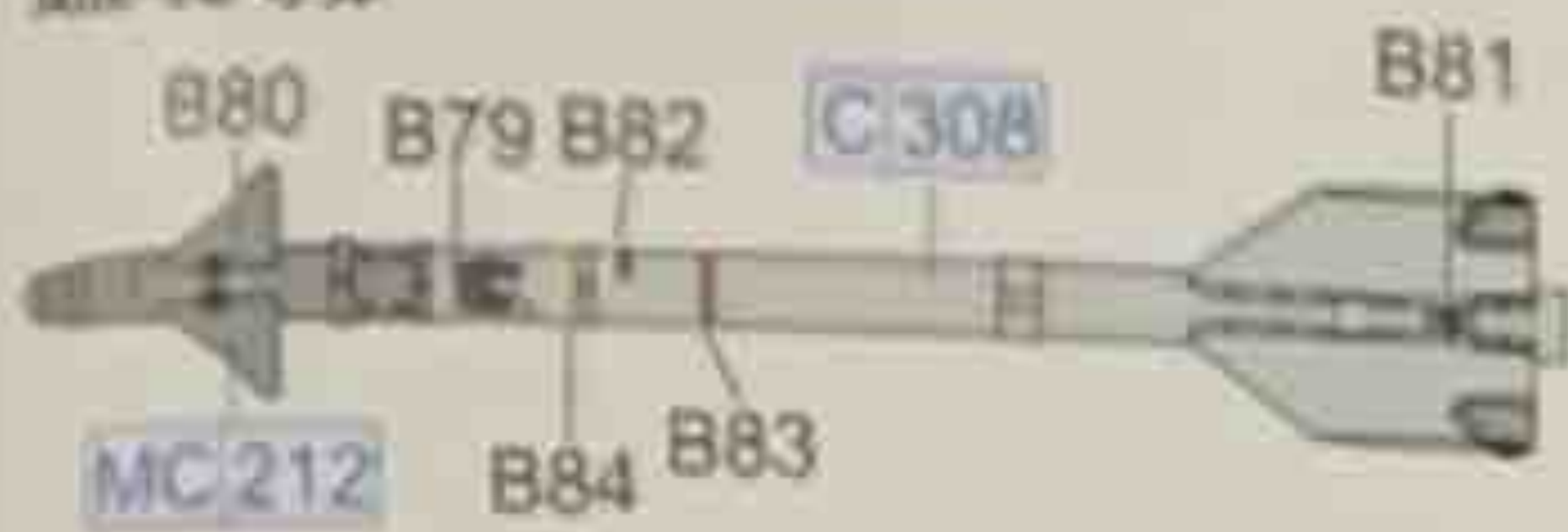

MK82 Bomb
MK82 炸弹



MK83 Bomb
MK83 炸弹



AGM-65 Maverick
小牛 空对地导弹



AN/ALQ-184 ECM POD
AN/ALQ-184 自卫式电子对抗(ECM)吊舱

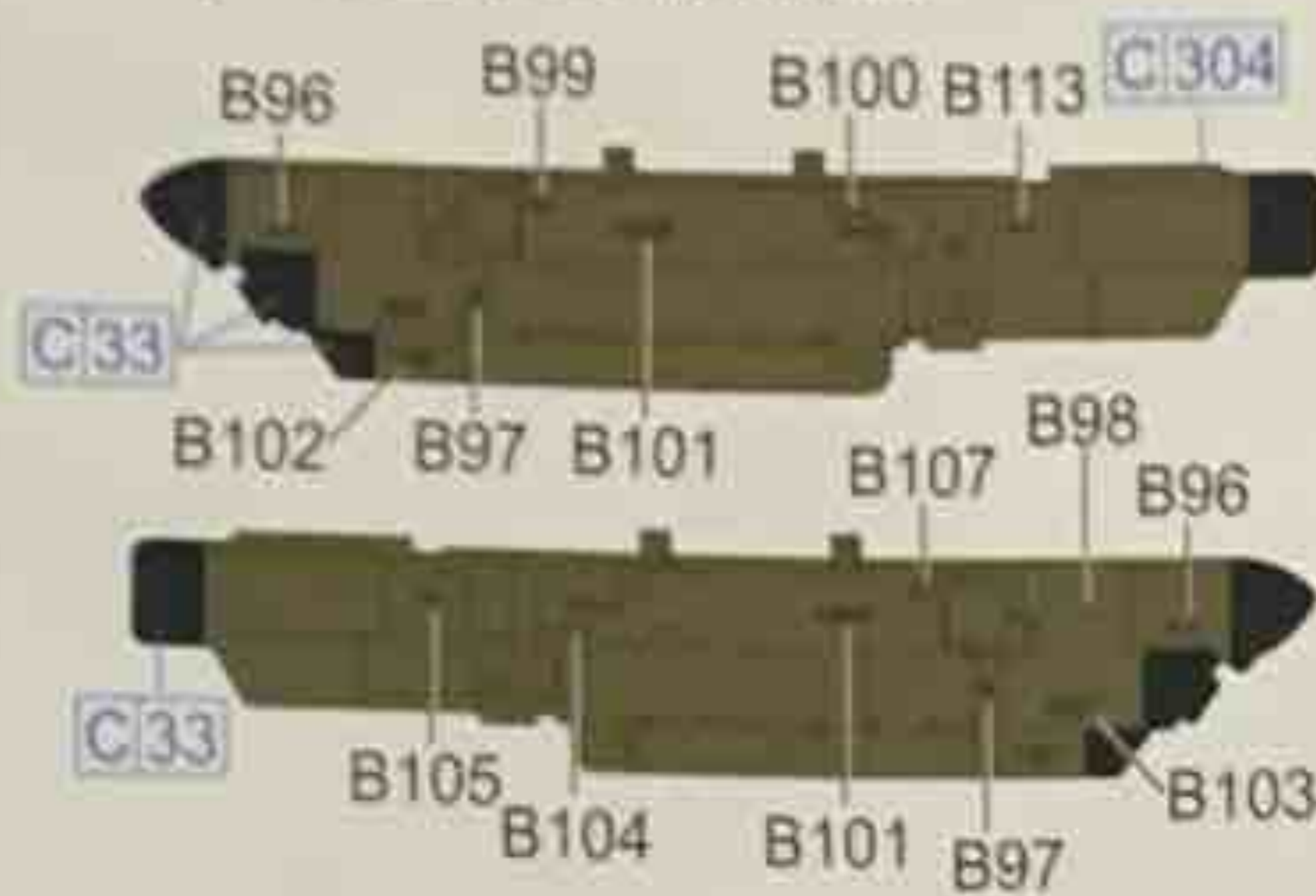

ALQ-131 ECM POD
ALQ-131 电子对抗(ECM)吊舱

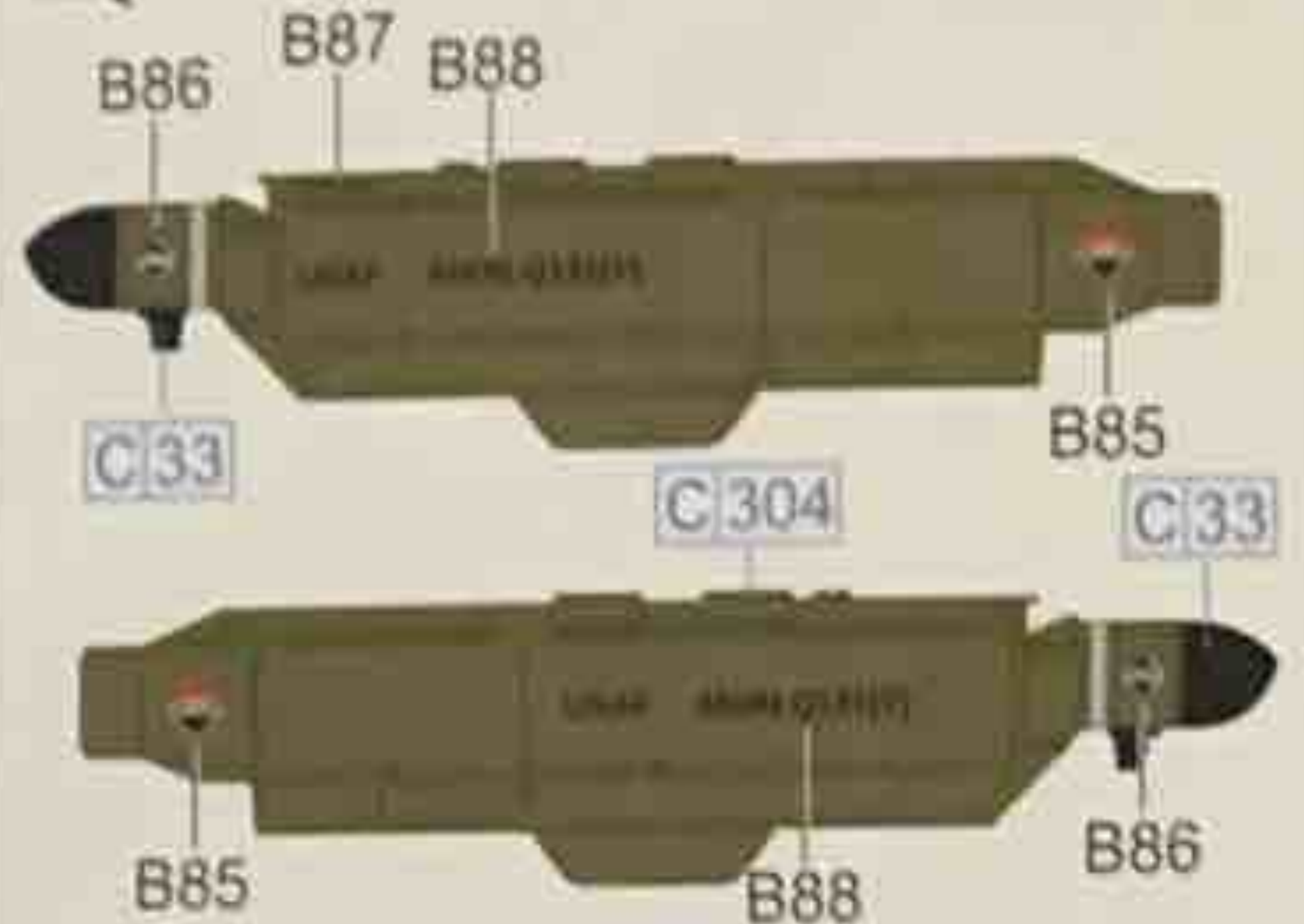

Twin Pylon
双联挂架



A-10 TANK
A-10 TANK 副油箱



BRU-42 Pylon
BRU-42 挂架



LAU-131 Launcher
LAU-131 火箭巢

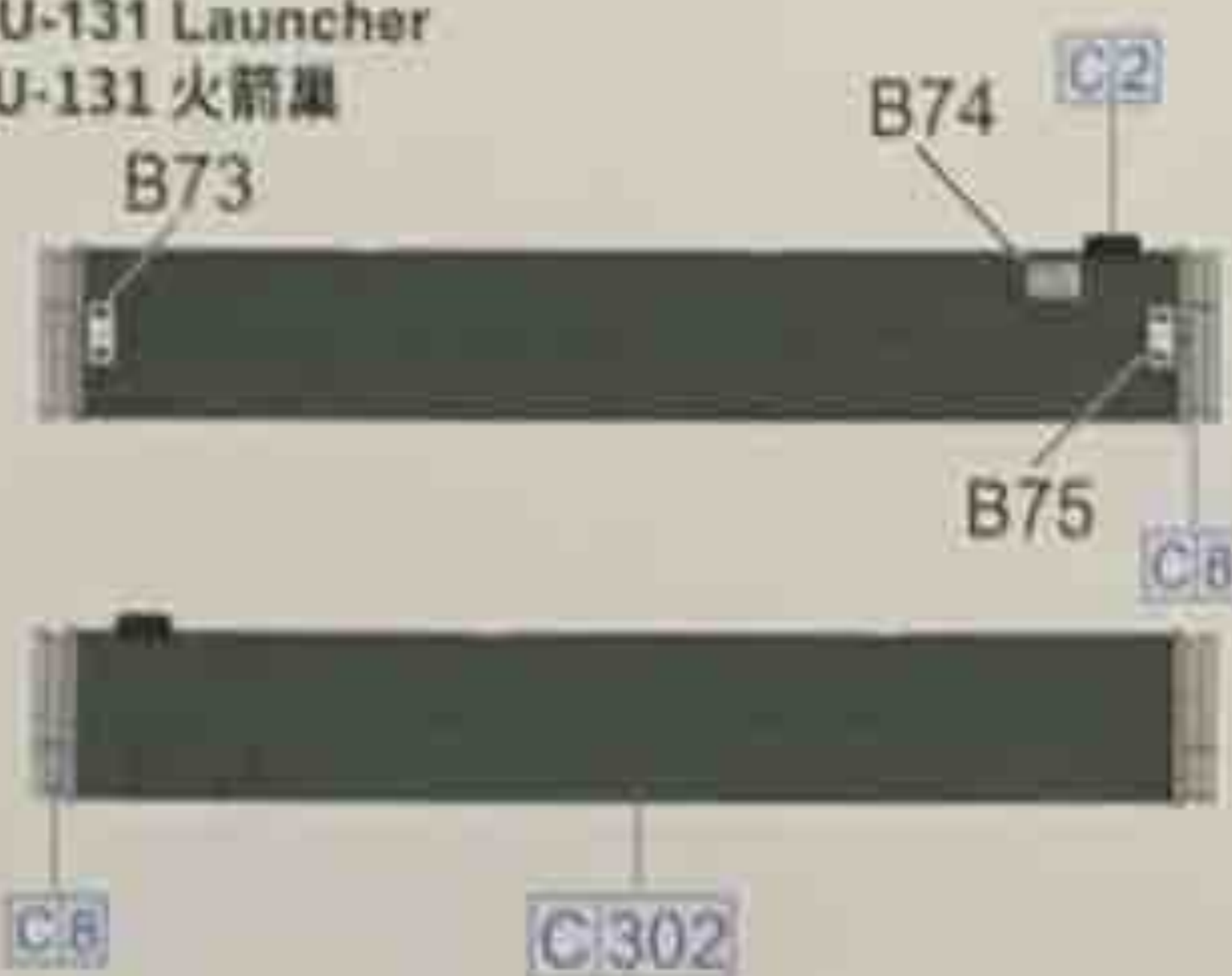

Pylon
挂架



45

Pylon 挂架



2

Pylon 挂架

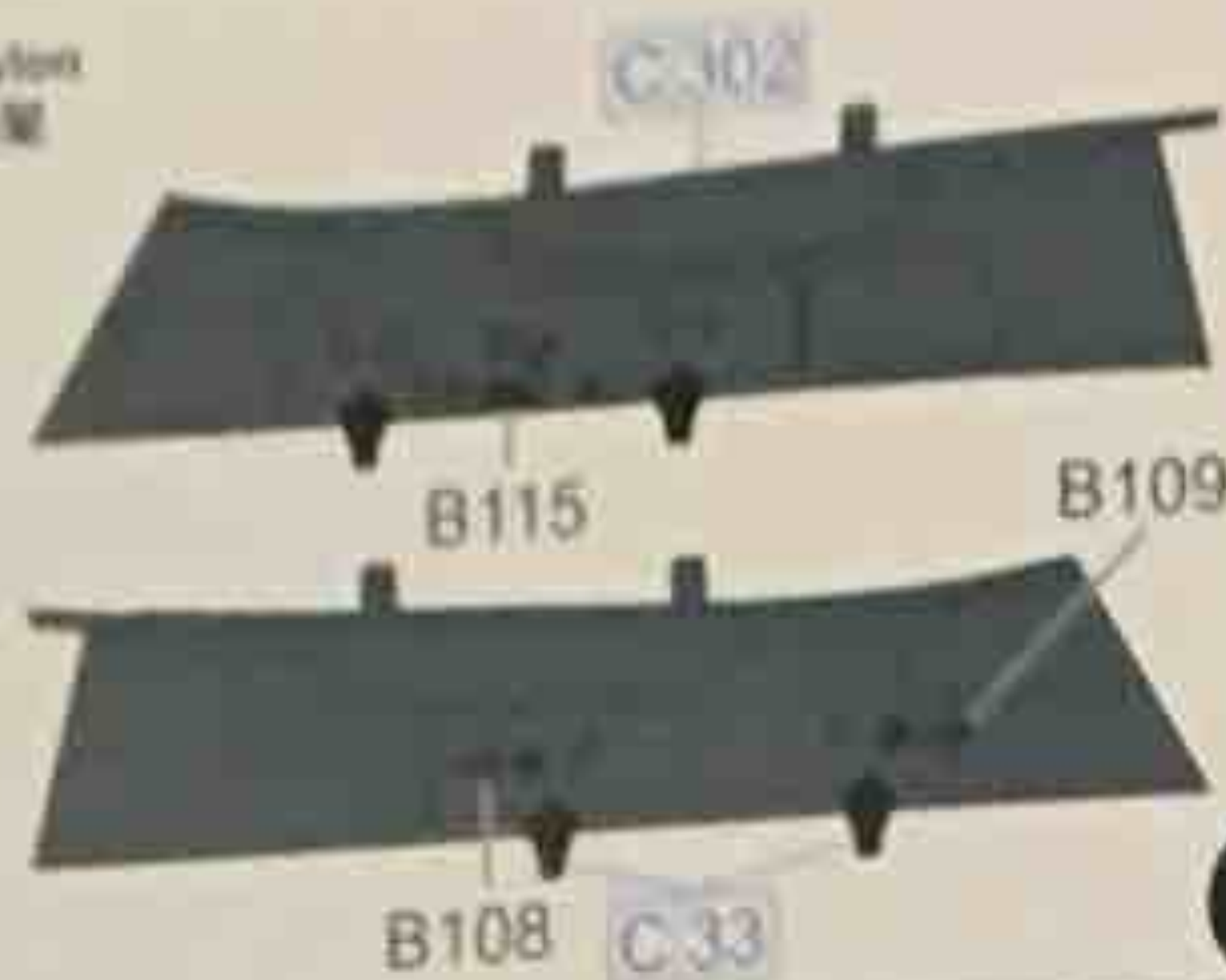

3

Pylon 挂架



4

Pylon 挂架



5

Pylon 挂架



6

Pylon 挂架



7

Pylon 挂架



8

Pylon 挂架



9

Pylon 挂架



10

Pylon 挂架



11

46

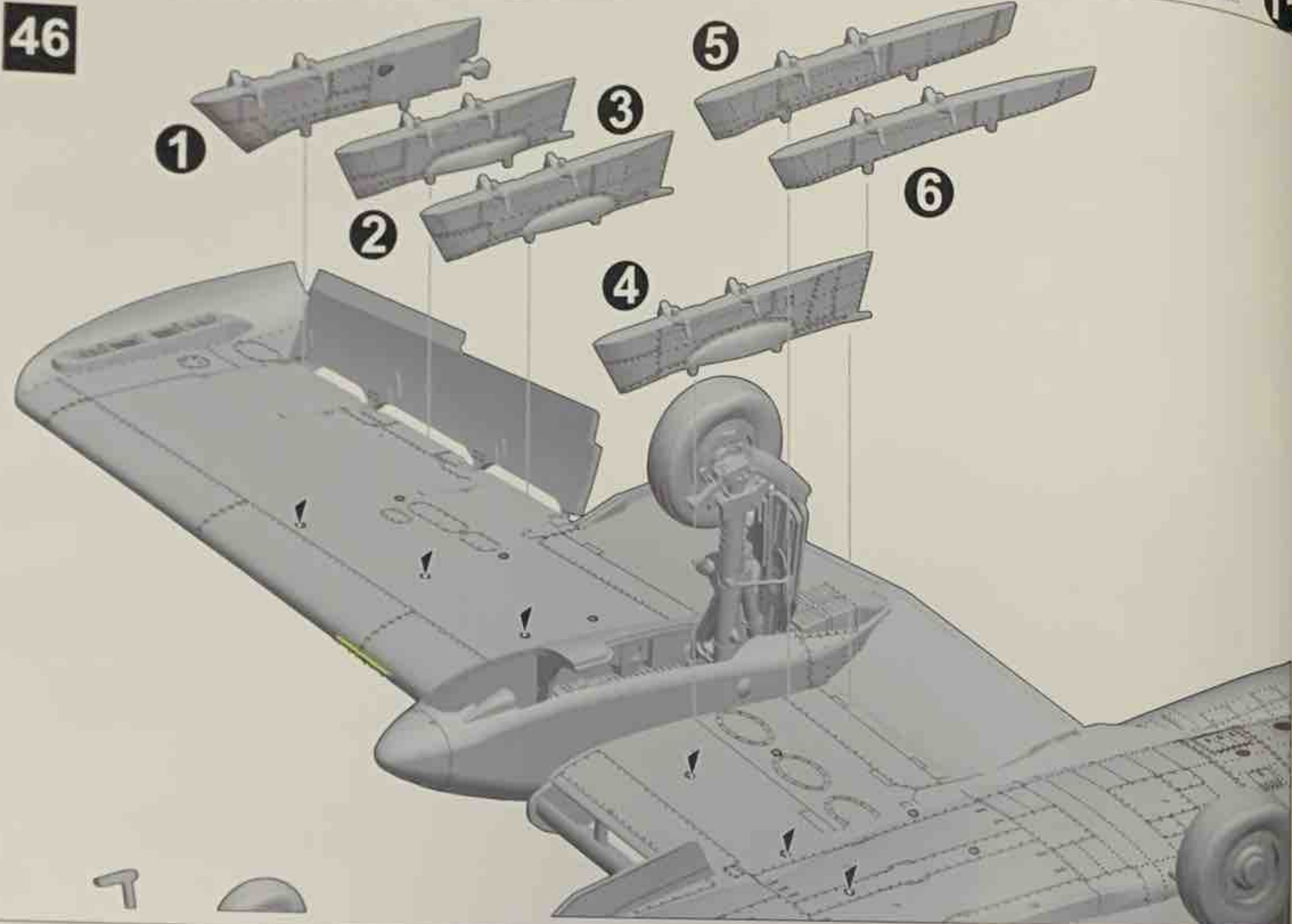

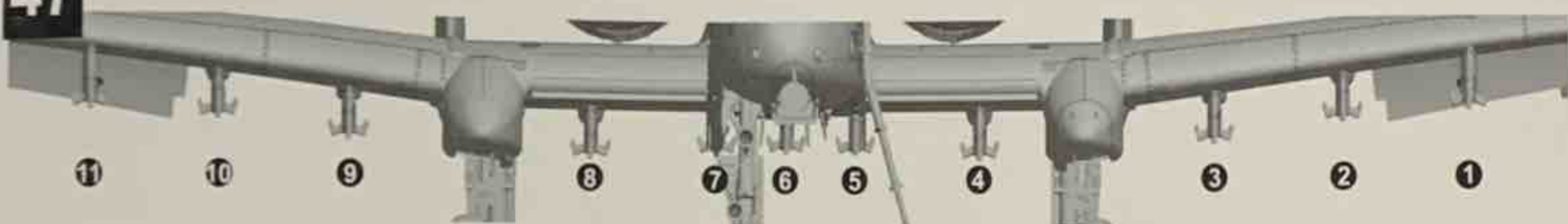
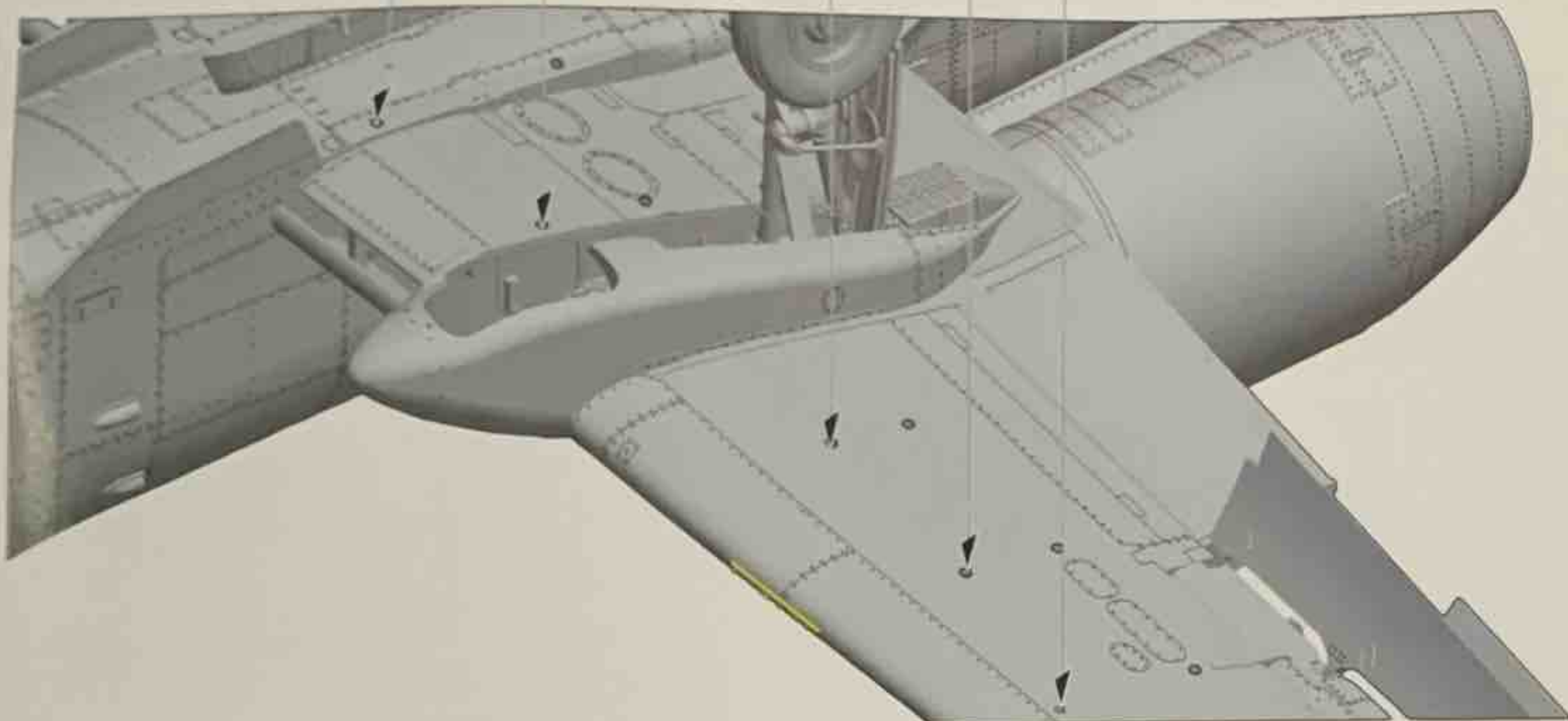
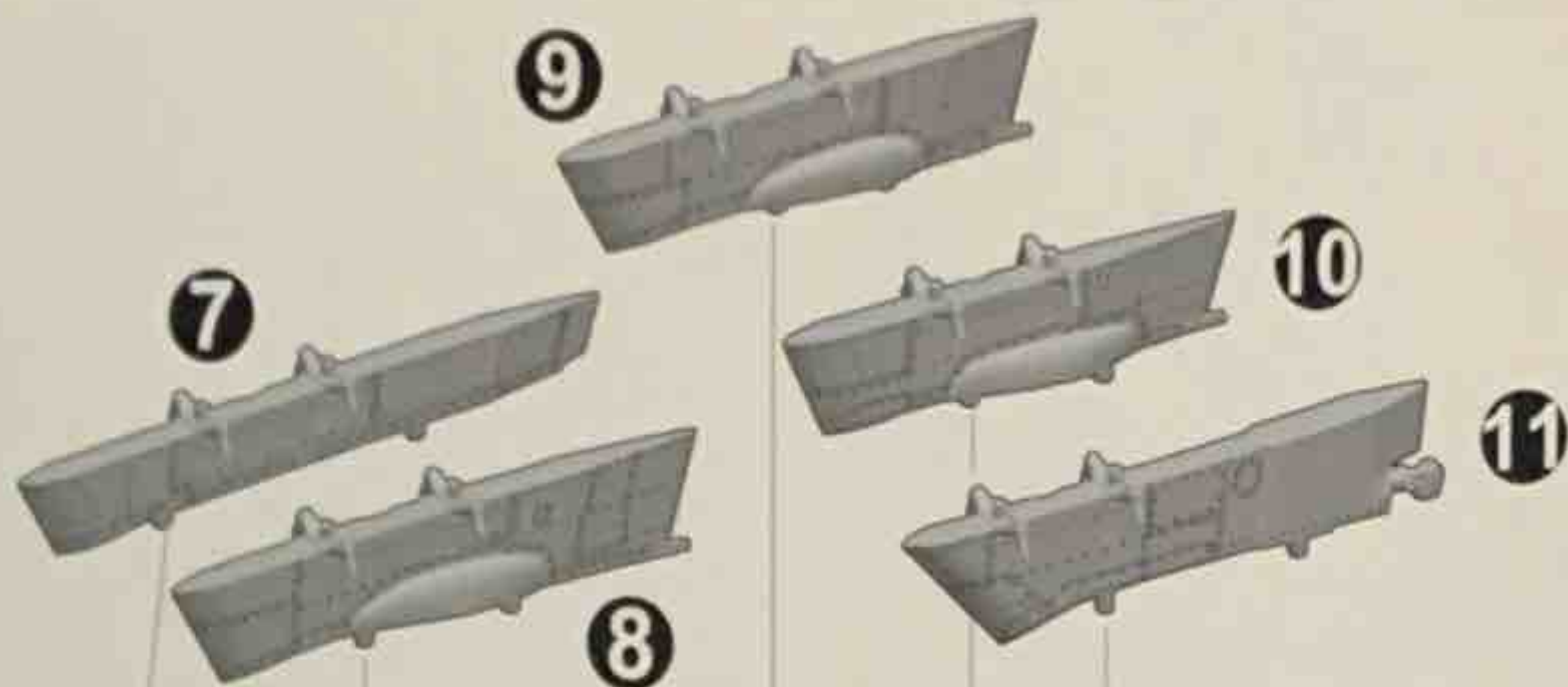

Weapon Ordnance 1
挂载方案 1

	11	10	9	8	7	6	5	4	3	2	1
AIM-9											● ●
Mk82				● ●	●		●	● ●			
AGM-65			●						●		
LAU-131		●								●	
ALQ-184(2)	●										
A-10 TANK						●					

Weapon Ordnance 2
挂载方案 2

	11	10	9	8	7	6	5	4	3	2	1
AIM-9											● ●
Mk82				●	●	●	●	●			
AGM-65			● ●						● ●		
LAU-131		●								●	
ALQ-184(2)	●										
A-10 TANK											

Weapon Ordnance 3
挂载方案 3

	11	10	9	8	7	6	5	4	3	2	1
AIM-9											● ●
Mk82				●				●			
Mk83					●		●				
AGM-65			●						●		
ALQ-131	●										
A-10 TANK						●					

