

1 TBD-1, white 42-S-16, VS-42, USS *Ranger* (CV-4), NAS Norfolk, Virginia, 1941.

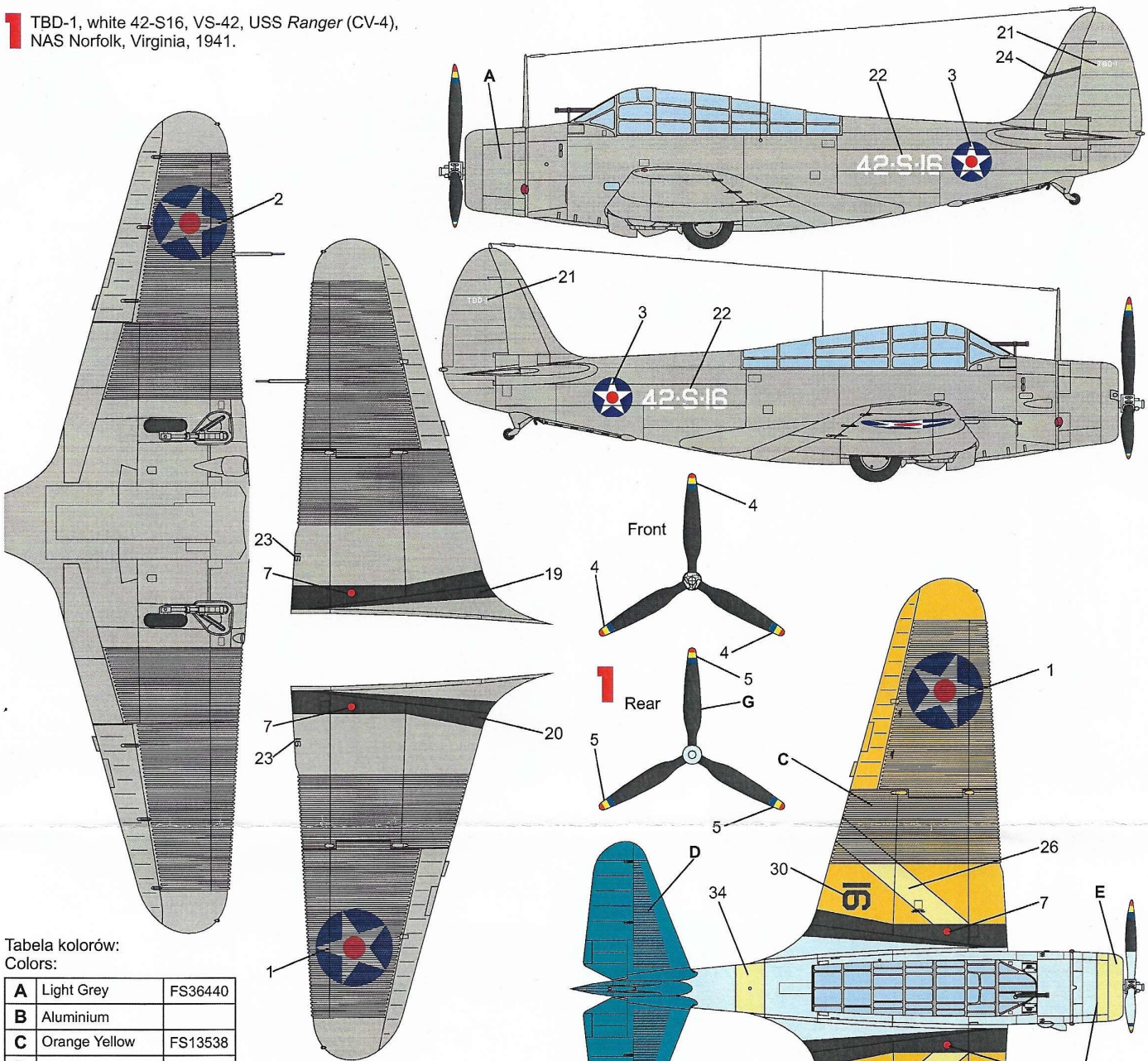

2 TBD-1, Bu.No. 0318, 6-T-16, VT-6, USS *Enterprise*, 1939.

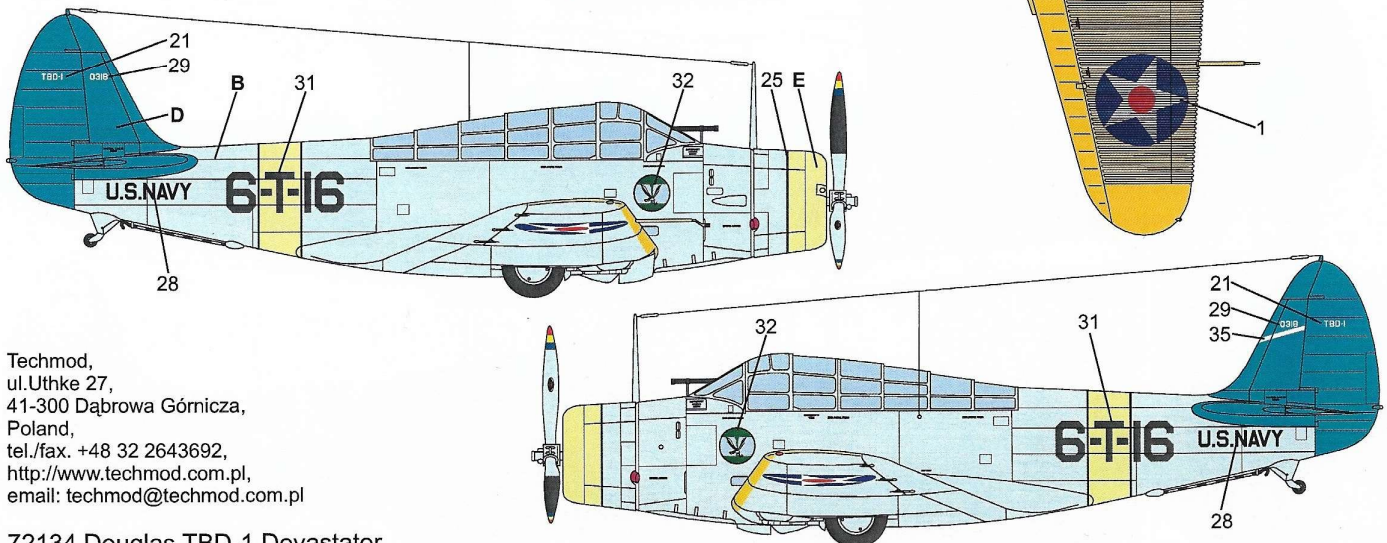

Techmod,
ul. Uthke 27,
41-300 Dąbrowa Górnica,
Poland,
tel./fax. +48 32 2643692,
<http://www.techmod.com.pl>,
email: techmod@techmod.com.pl

72134 Douglas TBD-1 Devastator

3 TBD-1, Bu.No. 0332, 5-T-8, VT-5,
USS Yorktown (CV-5), 1939.

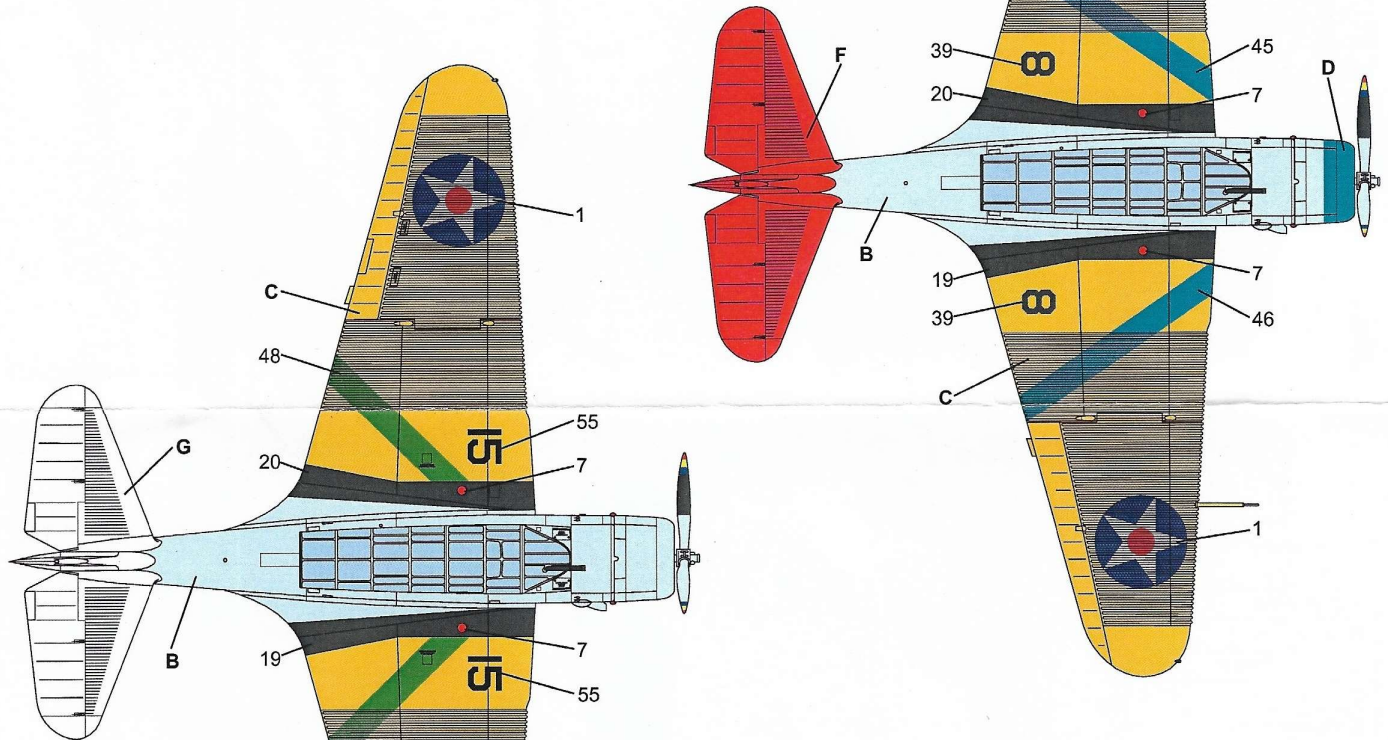
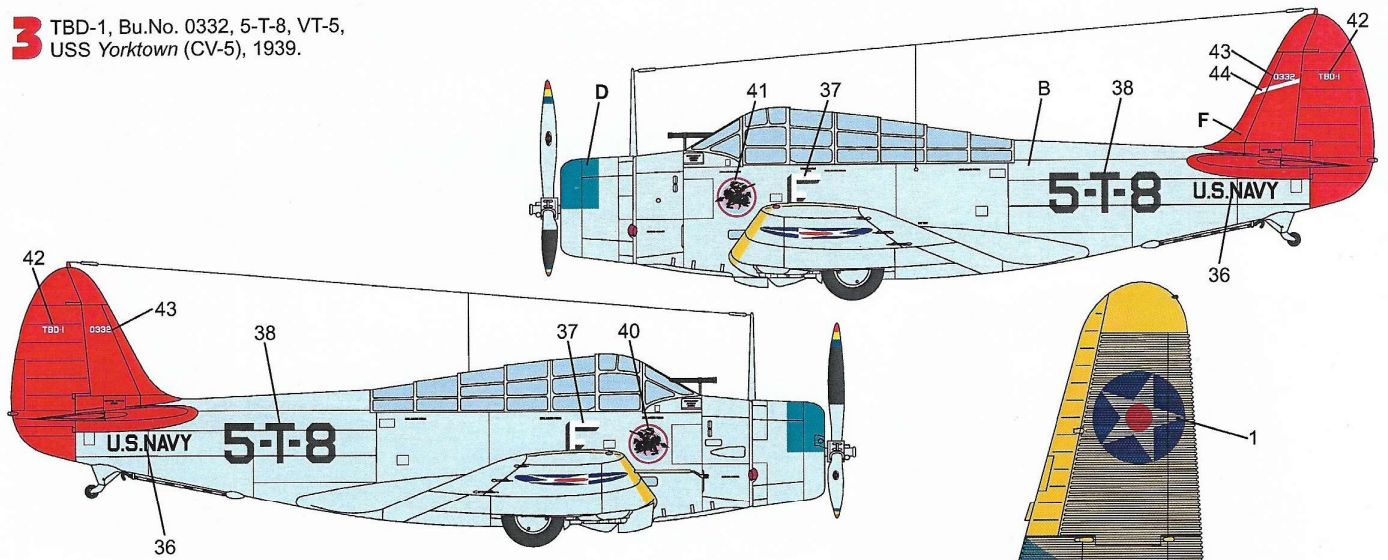

4 TBD-1, Bu.No. 0285, 3-T-15, VT-3, USS Saratoga (CV-3),
NAS North Island, San Diego, California, January 1938.

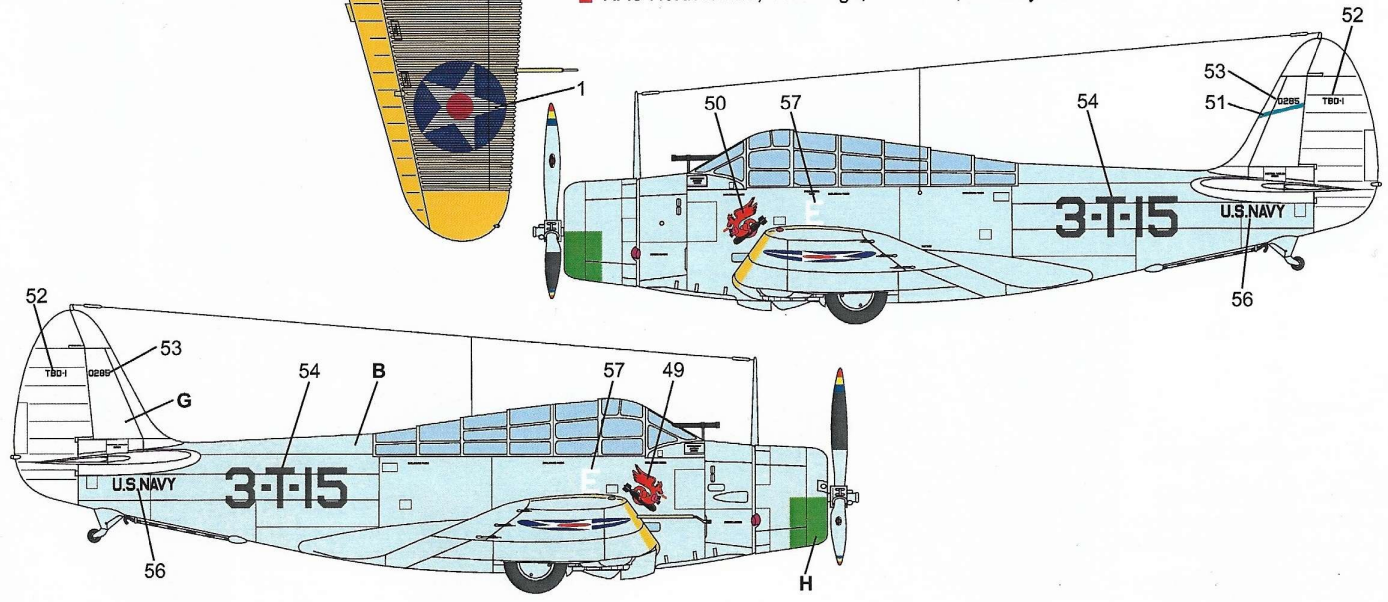

5 TBD-1, Bu.No. 0300, 2-T-1, Lt Cdr W. Sinton CO of VT-2,
USS *Lexington*, San Diego, California, 1938.



Tabela kolorów:
Colors:

A	Light Grey	FS36440
B	Aluminium	
C	Orange Yellow	FS13538
D	True Blue	FS15102
E	Lemon Yellow	FS13655
F	Insignia Red	FS11136
G	Matt Black	FS37038
H	Stainless Steel	



6 TBD-1, Bu.No. 0353, white 82, Naval Air Training Command,
NAS Pensacola, Florida, 1938.

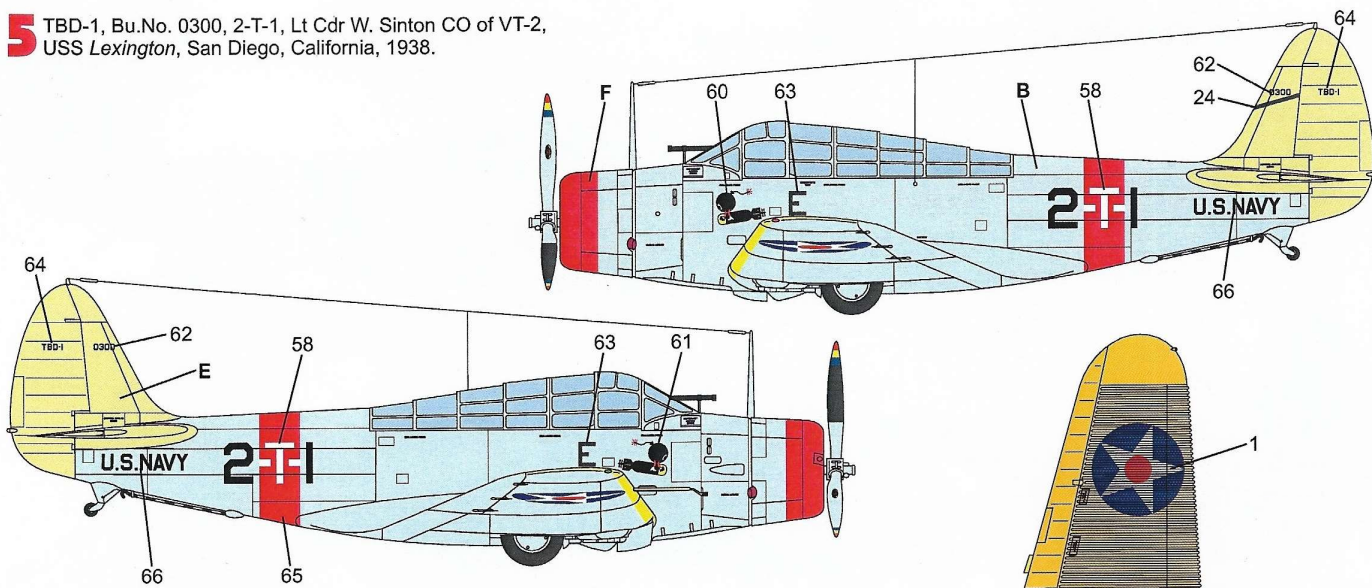
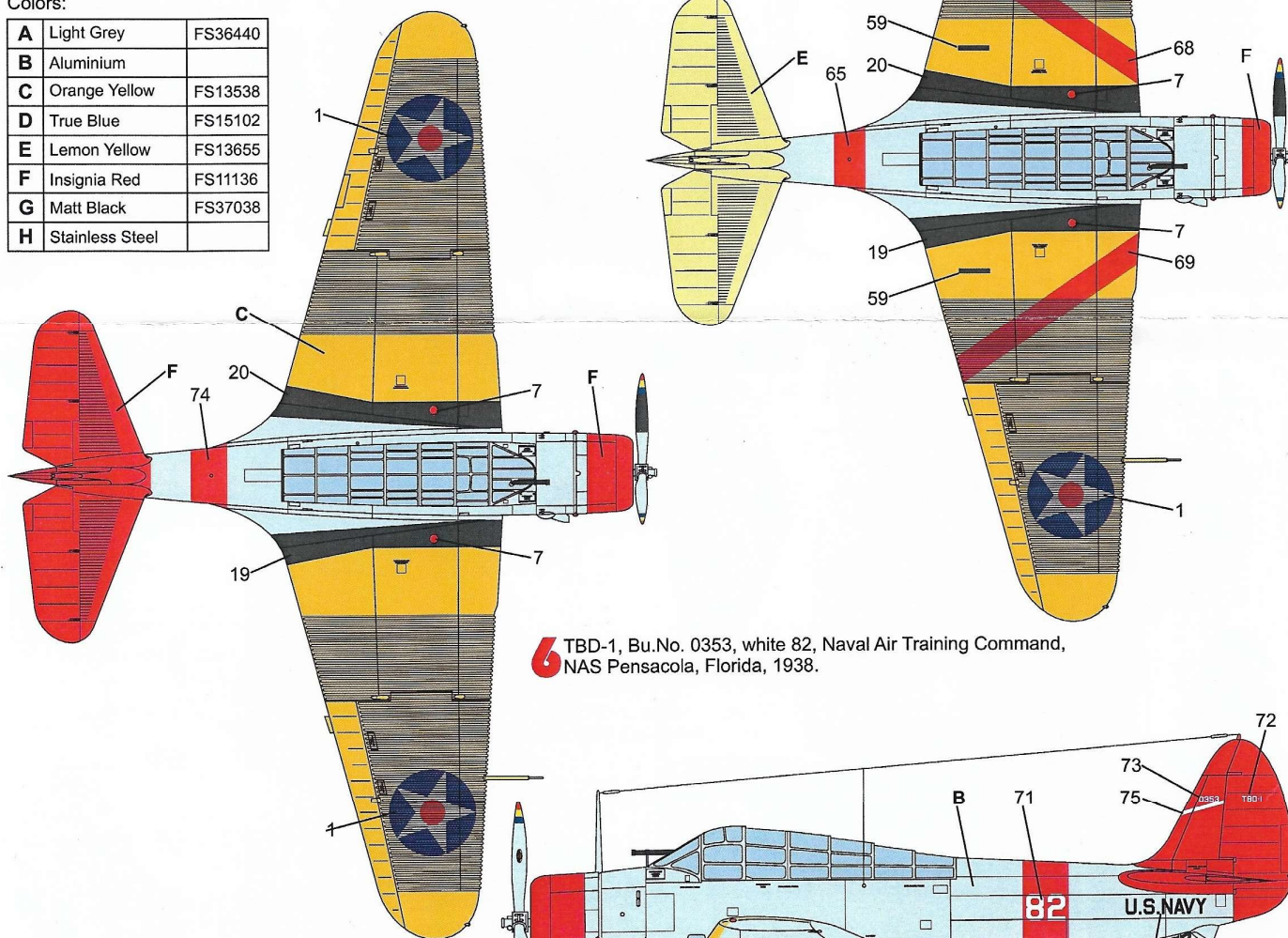
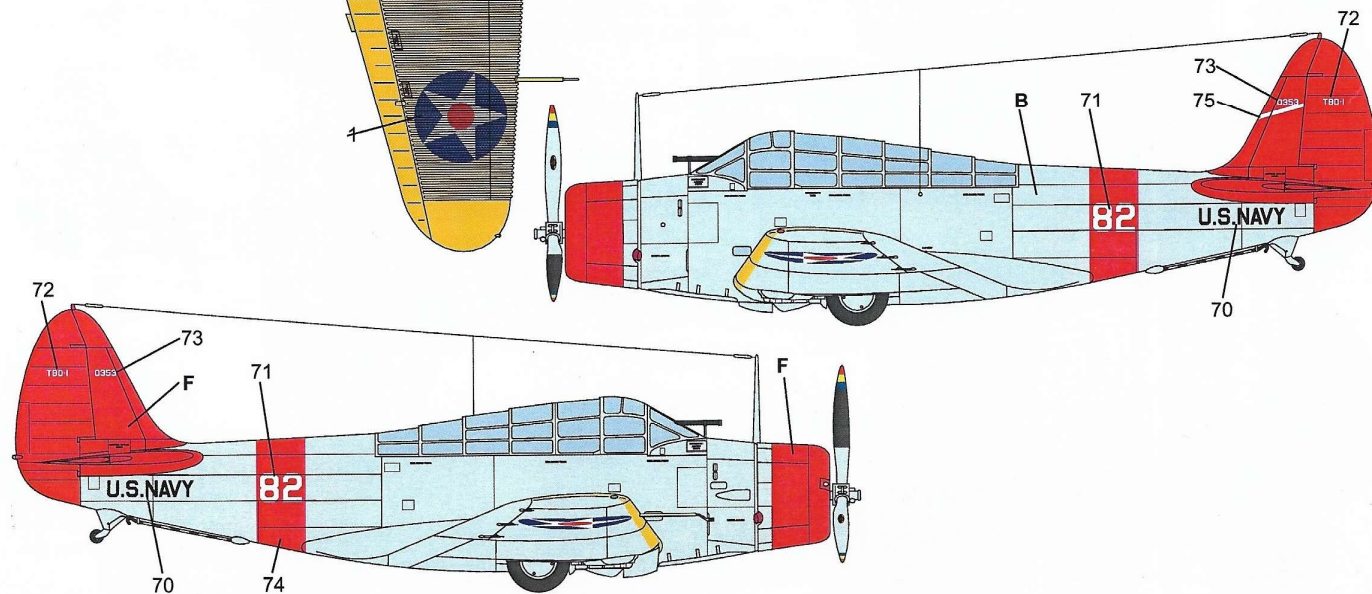

Stenciling details & Masks application

2,3,4,5,6

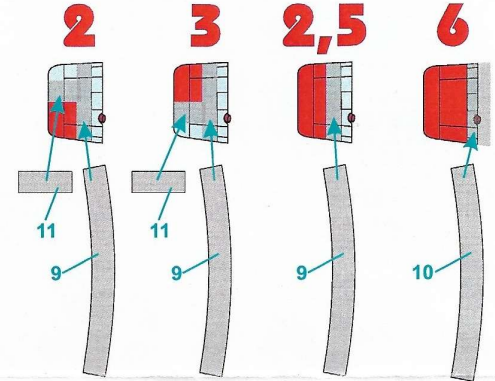
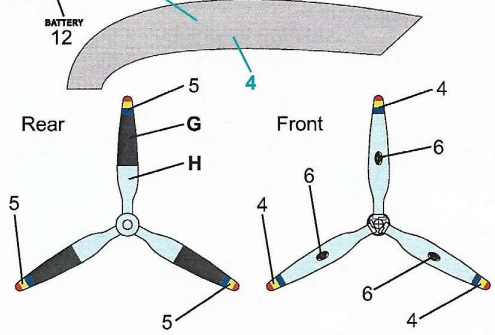
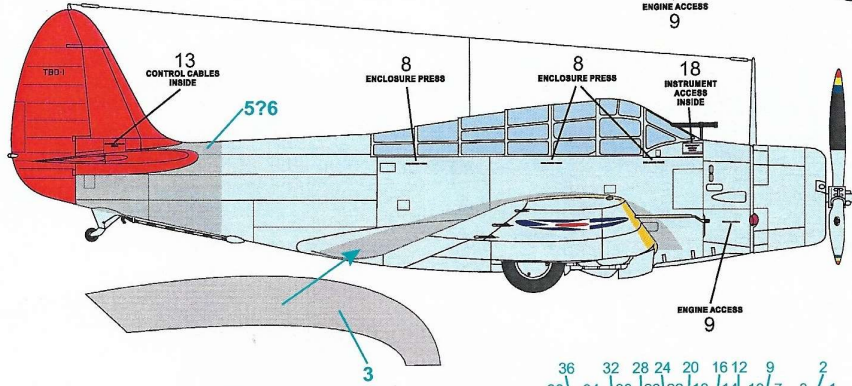
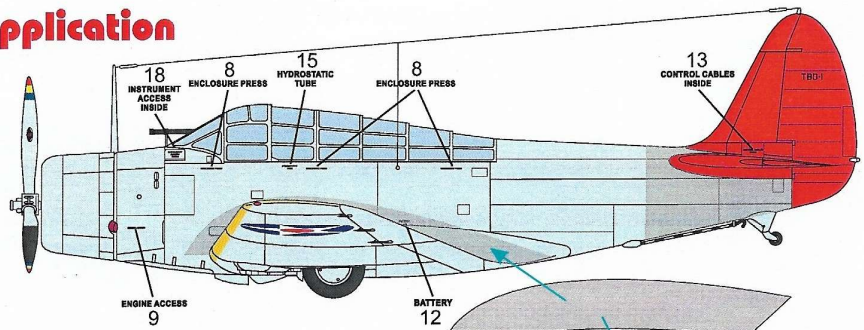

Canopy mask

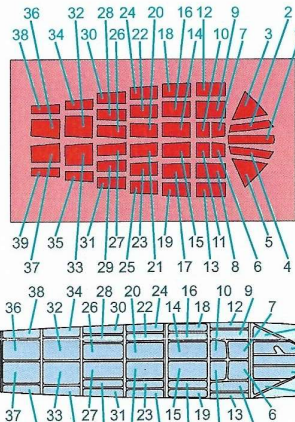

Recommended kit: Valom

2,3,4,5

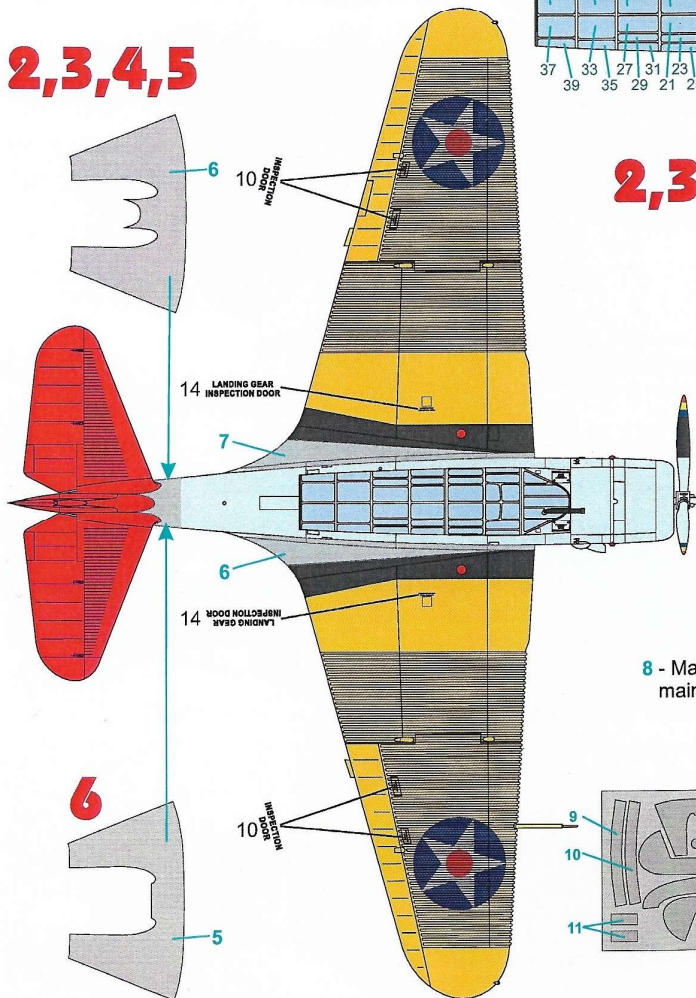

2,3,4,5,6

8 - Masks for wheels main landing gear.

