













# M4 EARLY TYPE PE UPDATE (For TAM 32505)

	切除阴影部分 Cut away		钻孔 Make a Hole
	锉平阴影部分 Rasp away		安装箭头 Install arrow
	填补 Use filler		弯折箭头 Fold arrow
	弧度弯折 Bend		蚀刻片零件标号 Number of PE parts
	根据喜好选择安装 Optional		原套件零件标号 Number of original parts
	另一侧相同制作 Repeat opposite side		被替换的套件标号 Number of replaced parts
	注解一 Note 1		使用圆棒制作 Use ABS rod



## VPE 48006 TAM

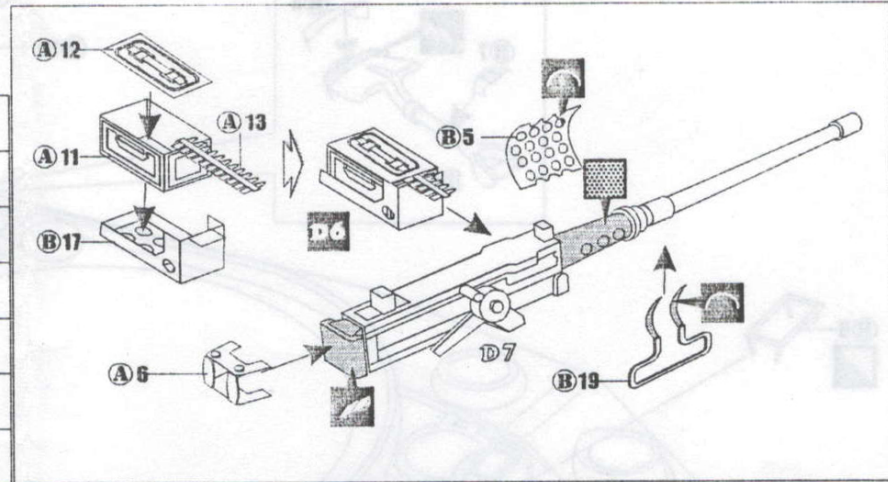
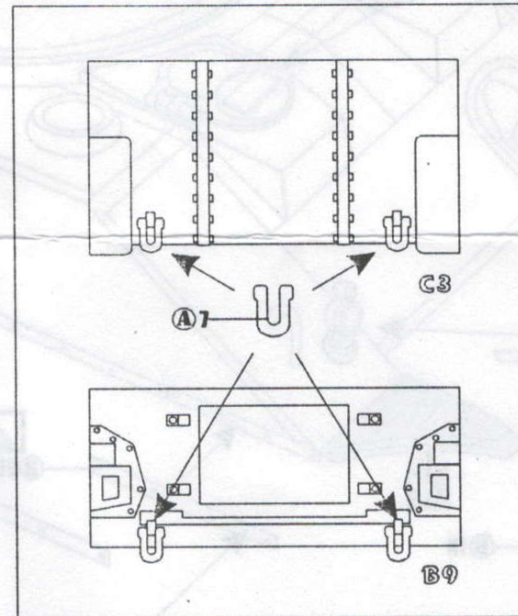
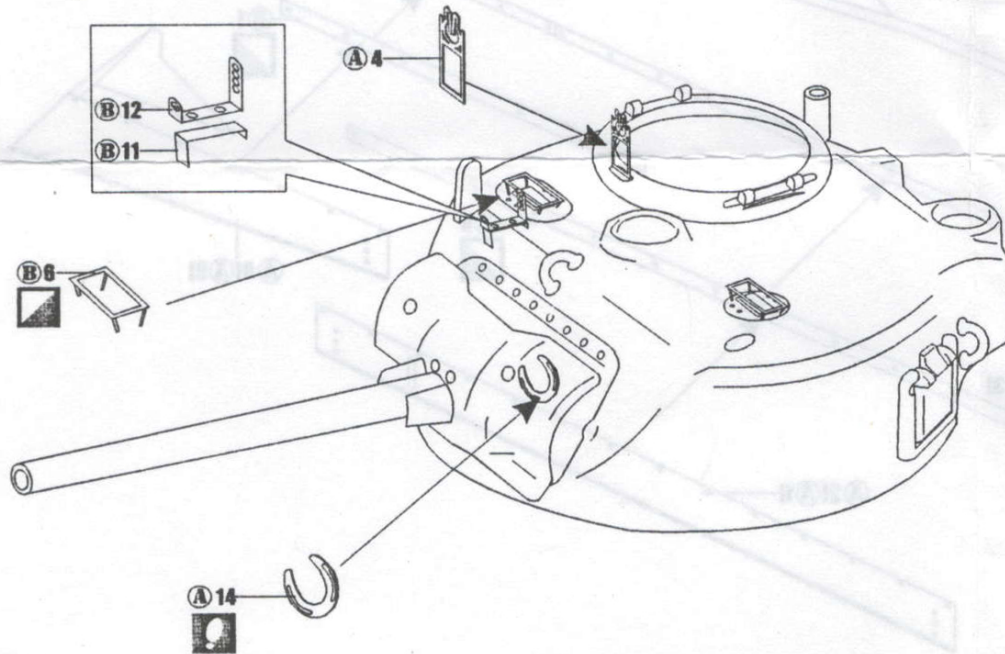

### 注解一: Note 1:

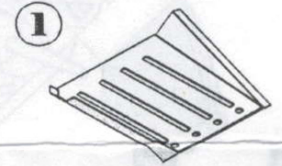

蚀刻片零件内侧面  
PE part Inboard side turn up

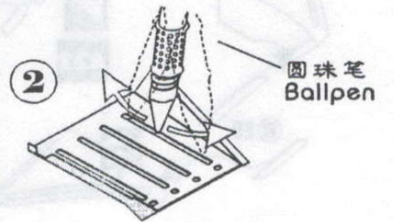

用笔尖在凹槽处挂  
Use penpoint scratch on the flute

