

FROG® F.268 LOCKHEED F-104 STARFIGHTER

How to put your Frog model together / Méthode d'assemblage de votre modèle Frog / Wie stellt man Ihr Frogmodell zusammen / Come

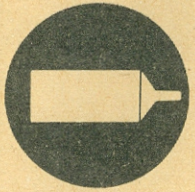

Cement parts together.
Coller les pièces ensemble.
Teile zusammenkleben.
Cementeer de delen samen.
Limma ihop delarna.
Cementare le parti l'una con l'altra.
Osat liimataan yhteen.

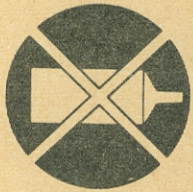

Do not cement together.
Ne pas coller ensemble.
Nicht zusammenkleben.
Cementeer niet samen.
Limma inte ihop delarna.
Non cementare le parti.
Osä ei liimataan yhteen.



Shape with a hot knife.
Former au canif chaud.
Mit einem heißen Messer formen.
Vorm met een heet mes.
Forma med varm kniv.
Modellare con la lama di un coltello, riscaldata.
Muovattaa kuumalla veitsellä.

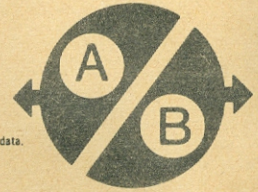

Choice of parts provided.
Choix de pièces fournies.
Mittelleferte Auswahl.
Keuze van beschikbare
Dessa delar medföljer.
Particolari a scelta.
Osien käyttö vaihtoehto.

1

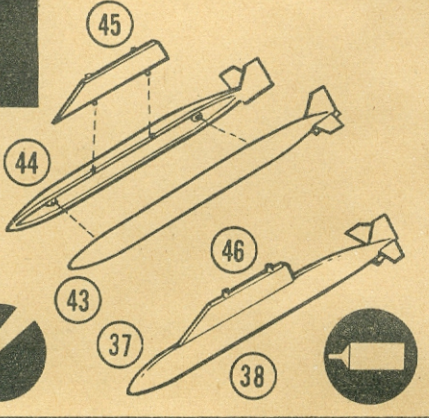

2

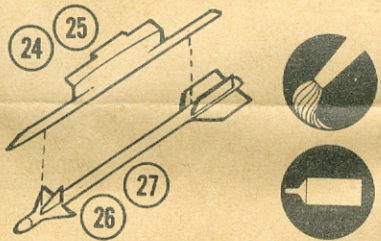

3

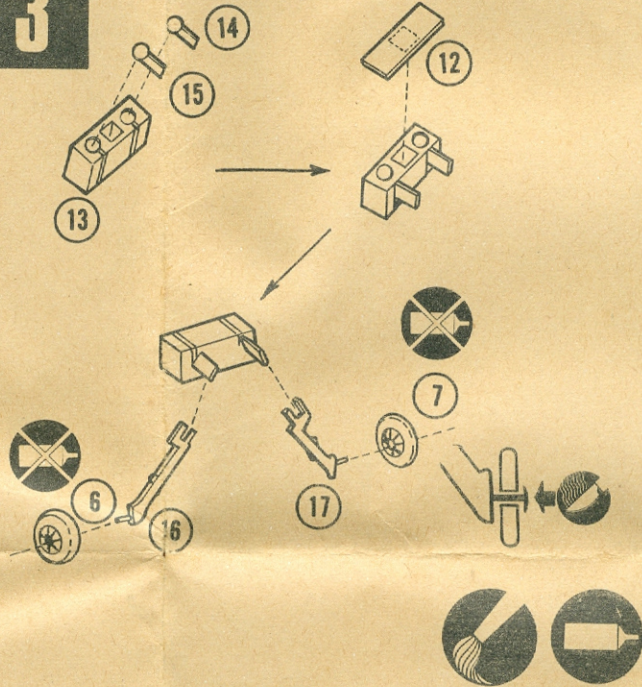

4

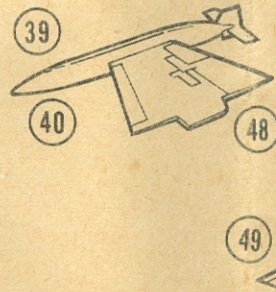

6

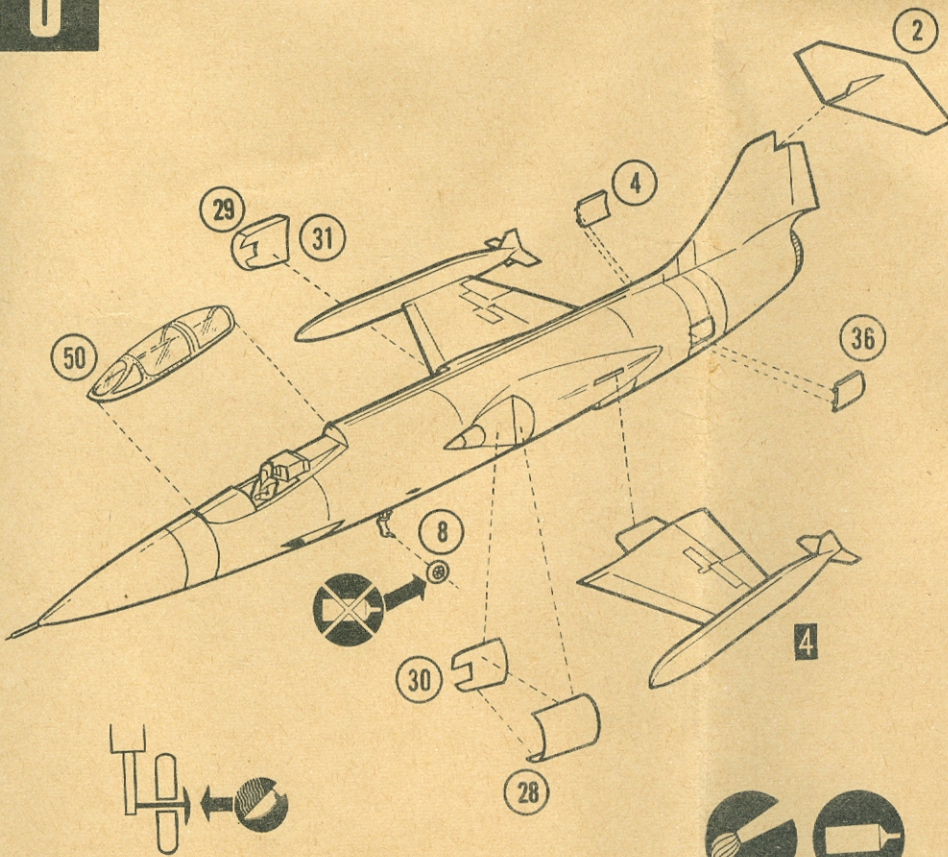

7

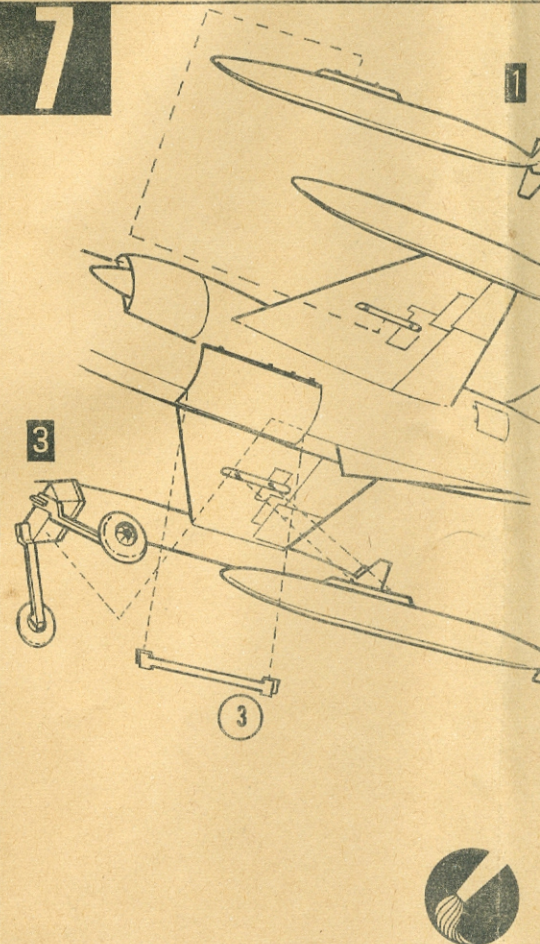

ome montare il modello Frog /Hoe zet ik mijn Frogmodel in elkaar/Hur man sätter ihop Frog-modellen/Kootkaa Frog mallinne näin.

parts provided.
 parts provided.
 Kuvattiin osien.
 osien.
 osien.
 osien.
 osien.
 osien.

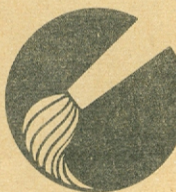

Paint parts before using.
 Peindre les pièces avant l'emploi.
 Die Teile sollen vor Benutzung bemalt werden.
 De onderdelen voor het gebruik schilderen.
 Mäla delarna före användningen.
 Verniciare le parti prima di montarle.
 Maalata osat ennen kokoamista.

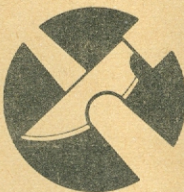

Cut with a sharp knife.
 Couper avec un couteau tranchant.
 Mit einem scharfen messe schneiden.
 Snijd met een scherp mes.
 Skär men en skarp kniv.
 Tagliare con un coltello affilato.
 Leikatkaa terävällä veitsellä.

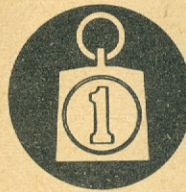

Insert small weight
 Introduire le petit contrepois.
 Das kleine Gewicht soll eingesteckt werden.
 Een klein gewichtje invoegen.
 Stick in en liten tyngd.
 Introdurre il piccolo peso
 Liittää pieni paino.

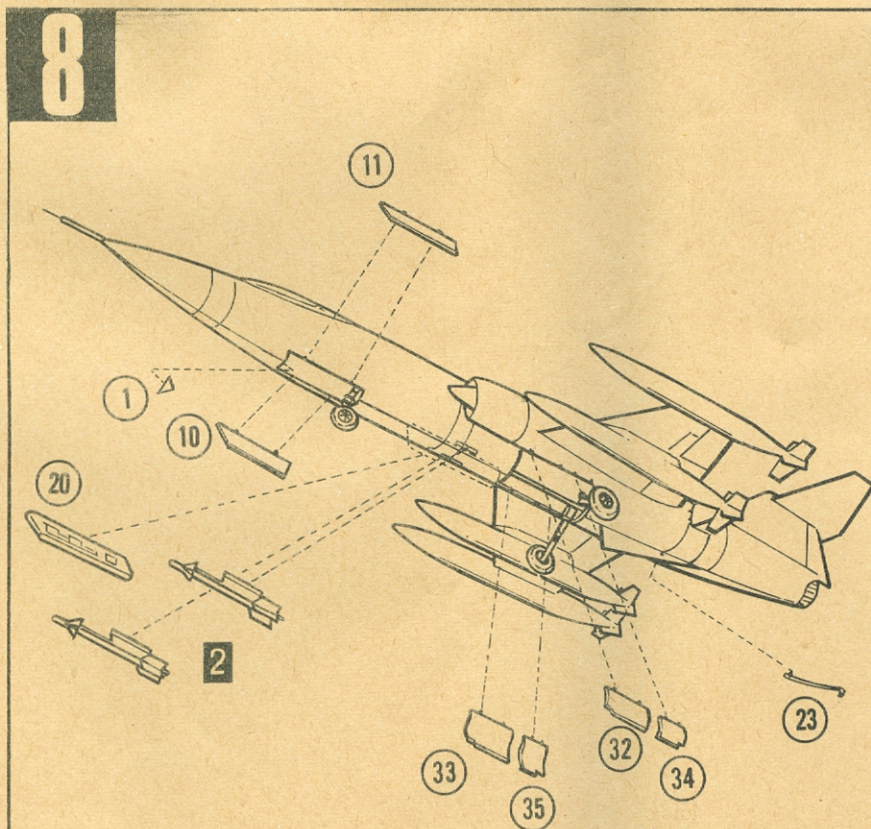
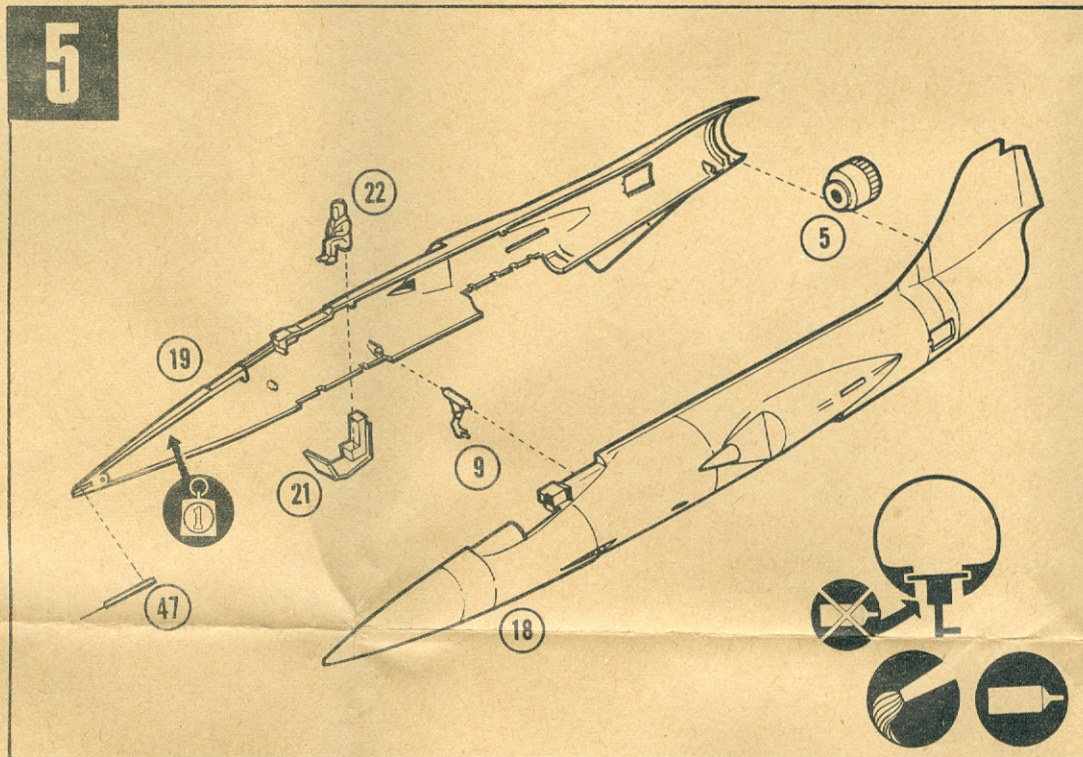
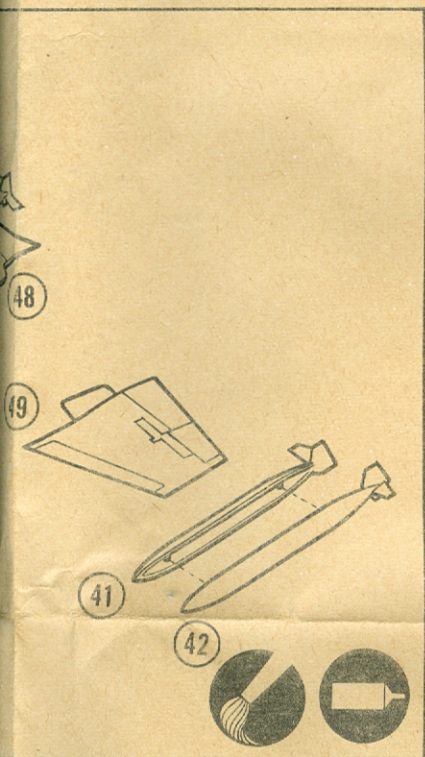

Name and Number of Kit.....

No. of Part.....

PLEASE USE BLOCK LETTERS

Name

Address.....

Every precaution has been taken to ensure that your kit will reach you complete. If however you find any part is faulty or missing please fill in the details opposite in block letters and return the slip to:

Rovex Triang Limited,
 Service Department,
 Westwood, Margate,
 Kent, England.

Please give the Number of the Part shown in the exploded assembly diagram in this instruction leaflet.