

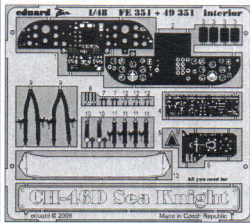

# CH-46D Sea Knight interior

**FE351**

1/48 scale detail set for ACADEMY/MRC kit • sada detailů pro model ACADEMY/MRC 1/48



- |  |   |                 |
|--|---|-----------------|
| APPLY EXPRESS MASK AND PAINT BEFORE GLUING<br>POUŽIT EXPRESS MASK NABARVIT PŘED SLEPENÍM | SYMMETRICAL ASSEMBLY<br>SYMETRICKÁ MONTÁŽ | BEND<br>OHNOUT  |
| REMOVE<br>ODSTRANIT  | GRIND<br>OBROUSIT                         | OPTION<br>VOLBA |
| DRILL HOLE<br>VRTAT OTVOR  | REPLACE<br>NAHRADIT                       |                 |

 ORIGINAL KIT PARTS  
PŮVODNÍ DÍLY STAVEBNICE

 PHOTO-ETCHED PARTS  
LEPTANÉ DÍLY

 PARTS TO BE REMOVED  
DÍLY K ODSTRANĚNÍ

 FILL  
TMELIT

## REFERENCES:

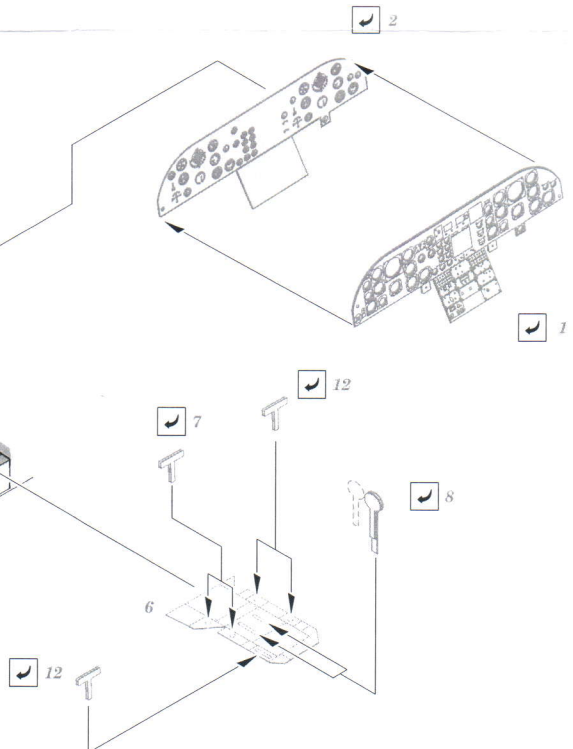
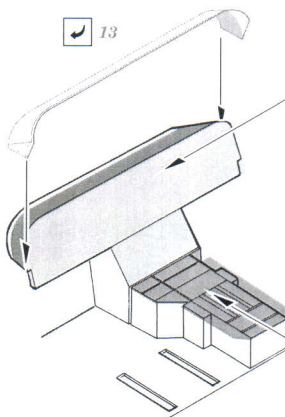
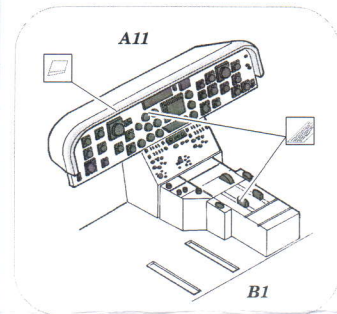
[www//helicopterwalk.czweb.org/rounds](http://www/helicopterwalk.czweb.org/rounds)

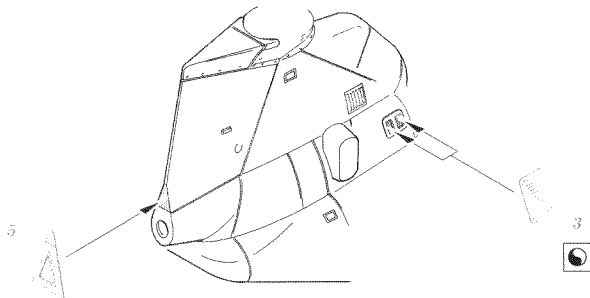
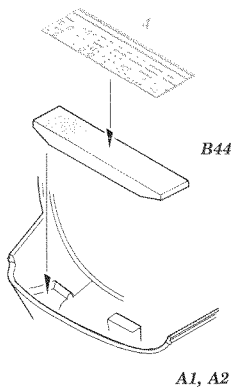
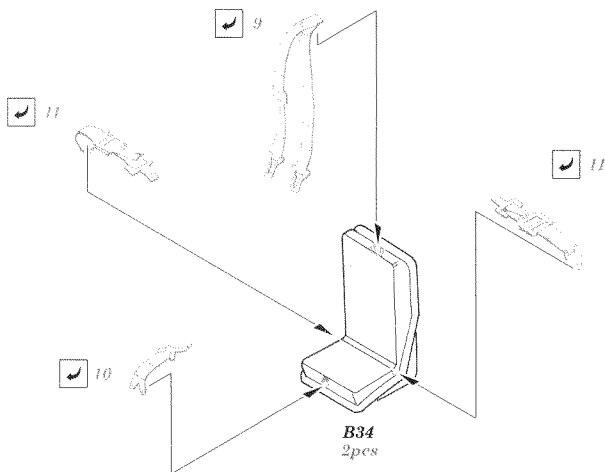

For further detail sets look for **eduard** 49 351 for HH-46D  
 ( not included in this set)

