

1/35 MILITARY MINIATURE VEHICLE UPGRADE SERIES PE35244









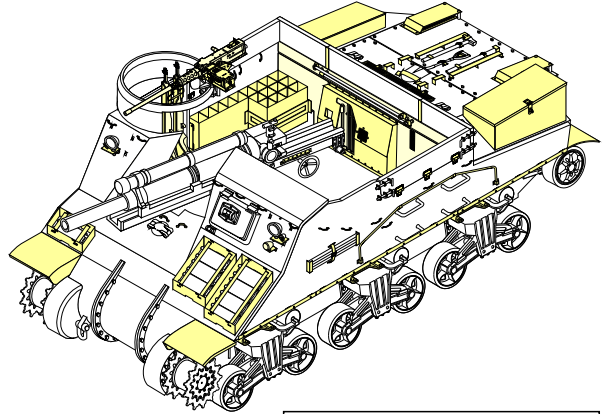
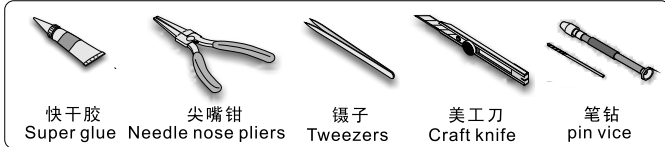

# WWII US Army M7 "Priest"

## 二战美国M7"牧师"自行榴弹炮改造件

[For ACADEMY 13210]

### 推荐使用工具 RECOMMENDED TOOLS



-   
 安装  
install
-   
 折叠  
bend
- A1**  
 改造件零件编号  
PE/resin part number
- B12**  
 原零件编号  
kit part number
- C22**  
 被替换的原零件编号  
replaced kit part number
-   
 另一侧相同制作  
repeat on opposite side
-   
 切除  
remove
-   
 打磨  
grind off
-   
 弧度卷曲  
radial bending
-   
 制作若干组  
multiple assembly
-   
 选择安装  
alternative
-   
 钻孔  
drill
-   
 用胶棒制作  
make from plastic rod

  
 用尖端在凹槽处冲压  
use penpoint to press on the dent

蚀刻片零件内侧面向上  
Put the part upside down  
 用笔尖在凹槽处刺  
Use penpoint to press on the dent

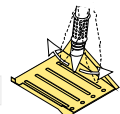

∅0.3  
x4

**C20**

上车体改造  
detailing upper hull

树脂件  
Resin part

D23    **D35 x2**

树脂件  
Resin part

A22[A22]    A26[A26]    A1[A1]

0.3mmx4.0mm    **C51C61**

**B28, B8**  
**B36, B35**

**C11**  
**B42**

**G4**

D1    **C8**  
0.5mmx1.0mm    **x6**

1/35 MILITARY MINIATURE VEHICLE UPGRADE SERIES PE35244

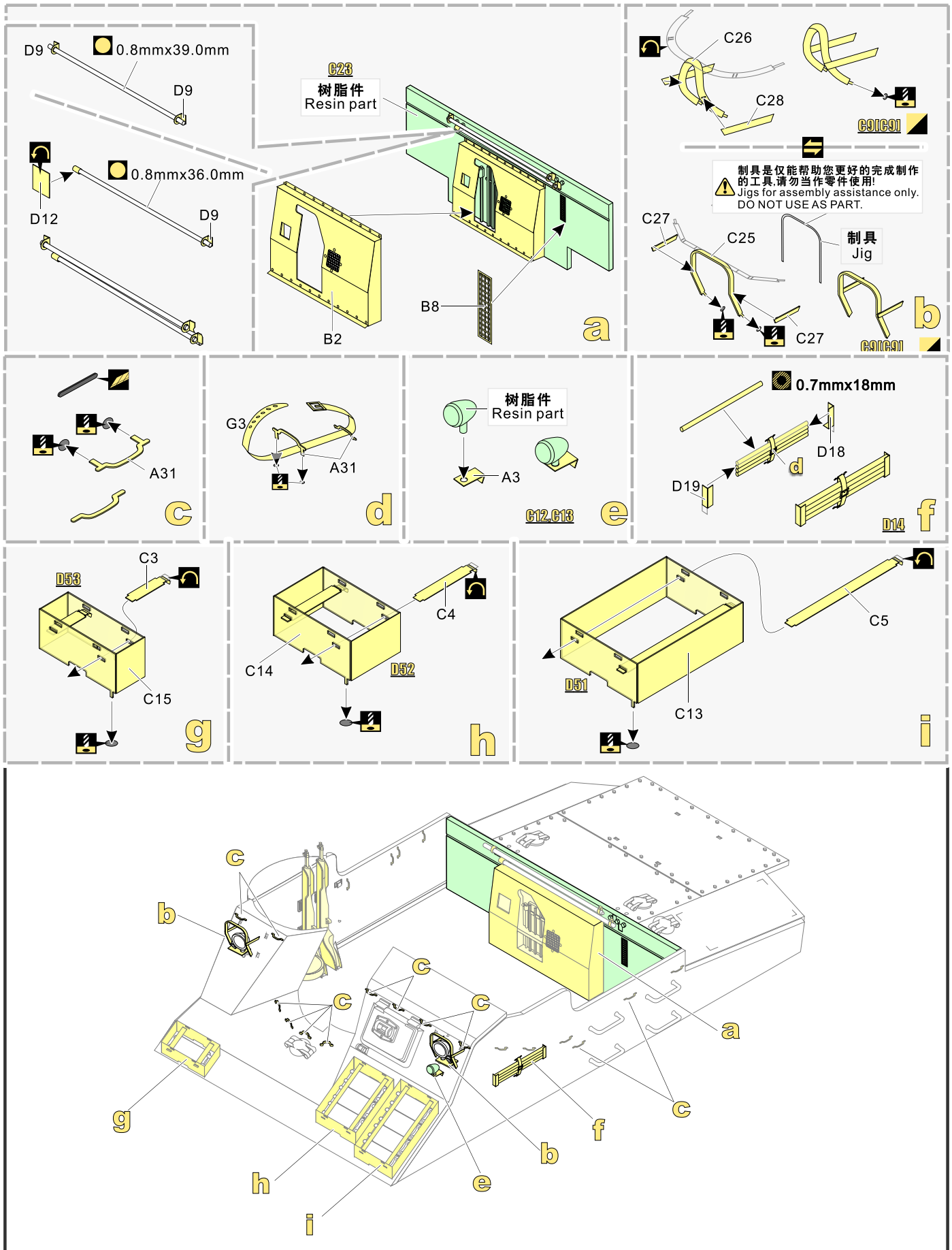

1/35 MILITARY MINIATURE VEHICLE UPGRADE SERIES PE35244

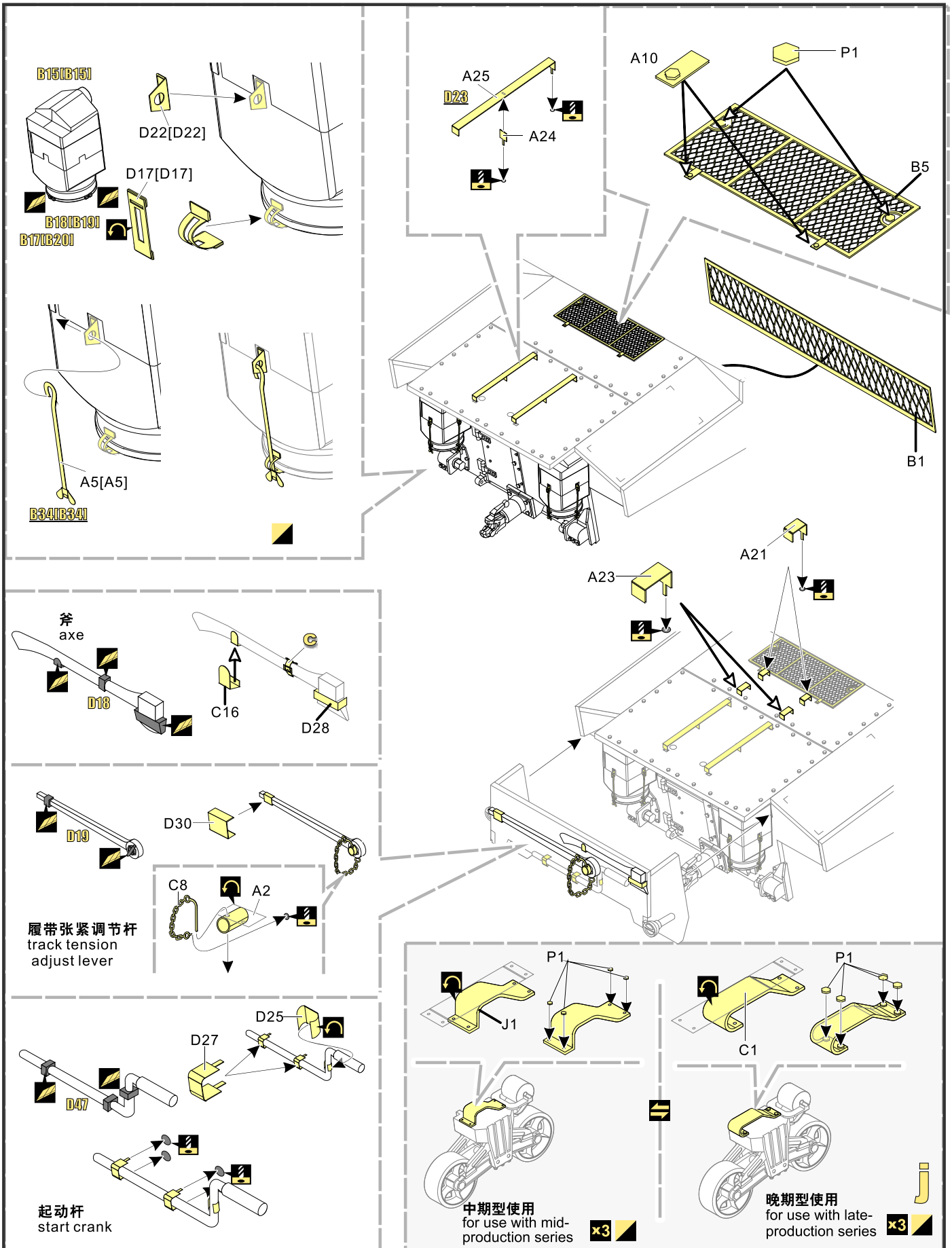

1/35 MILITARY MINIATURE VEHICLE UPGRADE SERIES PE35244

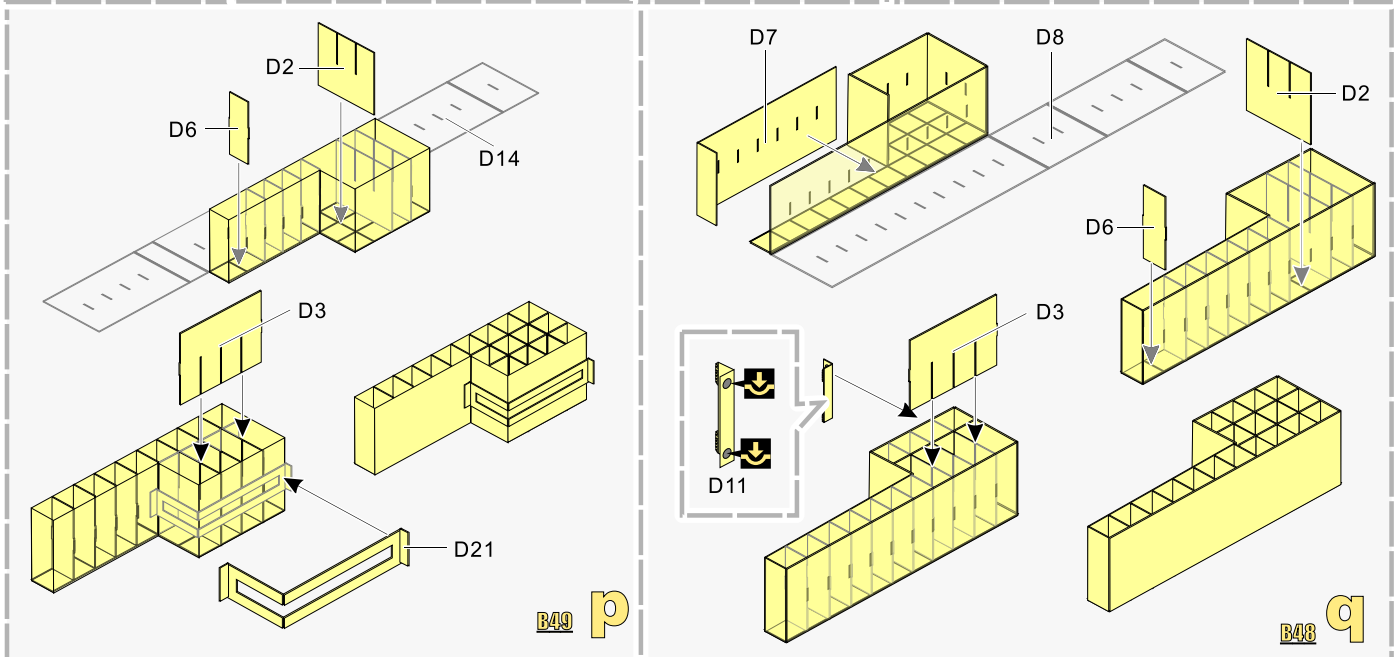
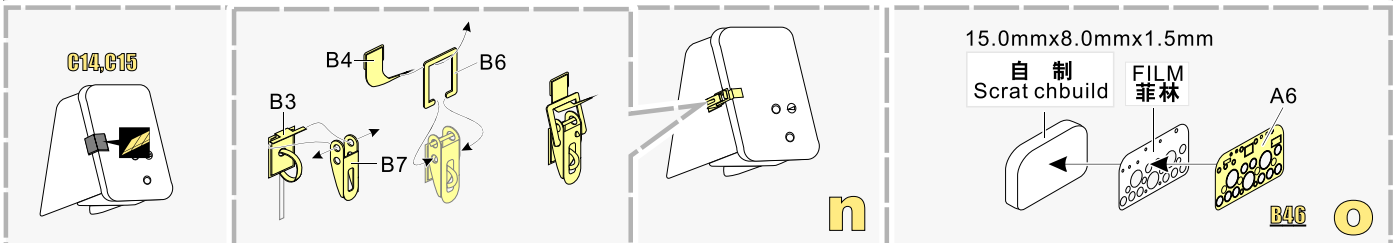
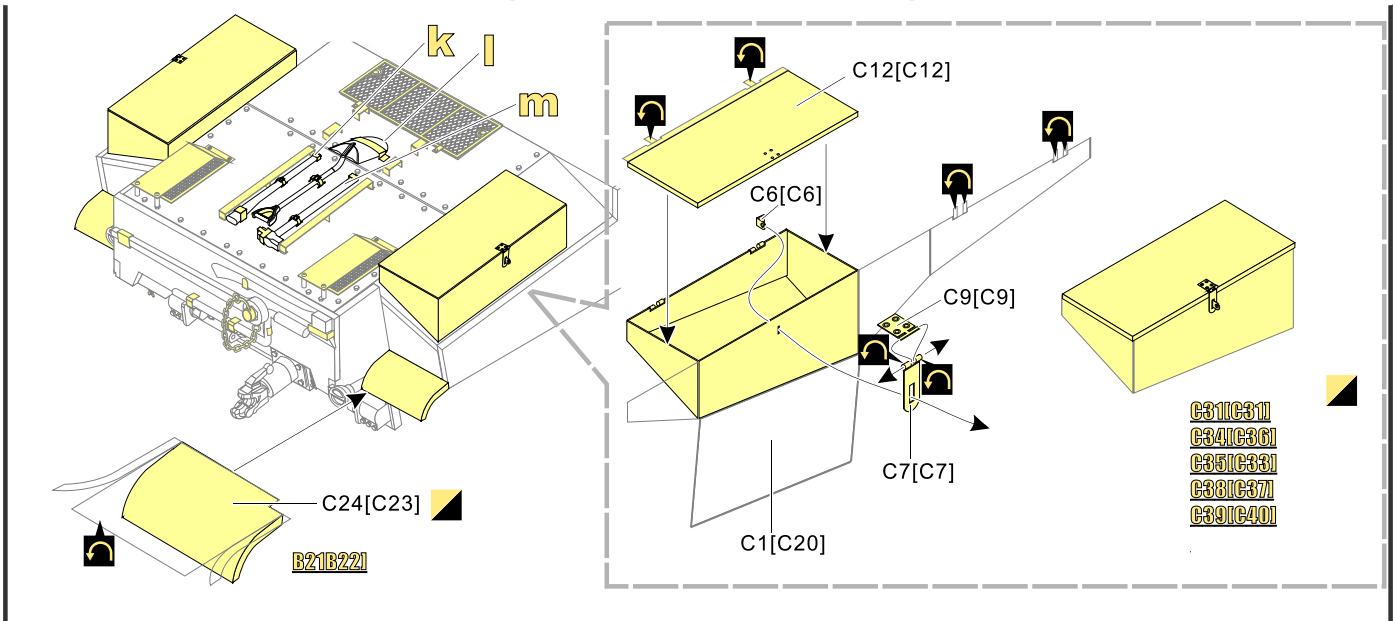
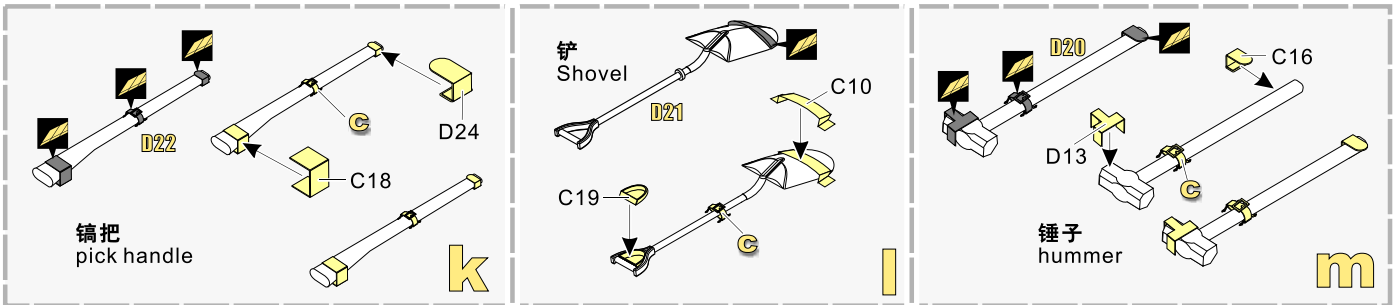

1/35 MILITARY MINIATURE VEHICLE UPGRADE SERIES PE35244

利用此3模板用1mm胶版自制装甲  
use these three templates and  
1mm plastic fabricate armour plate

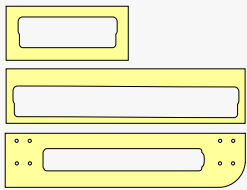

自制完成后  
completed result

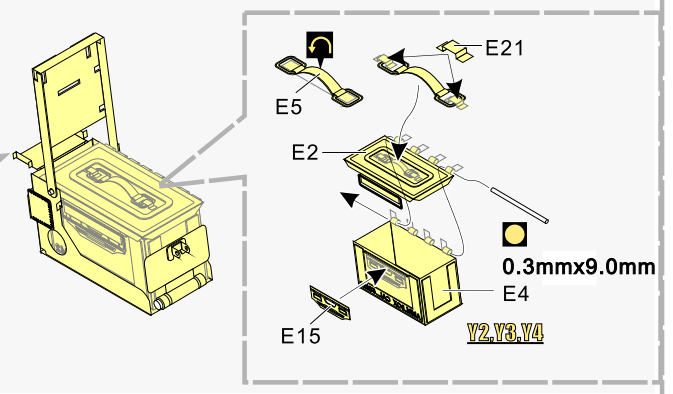
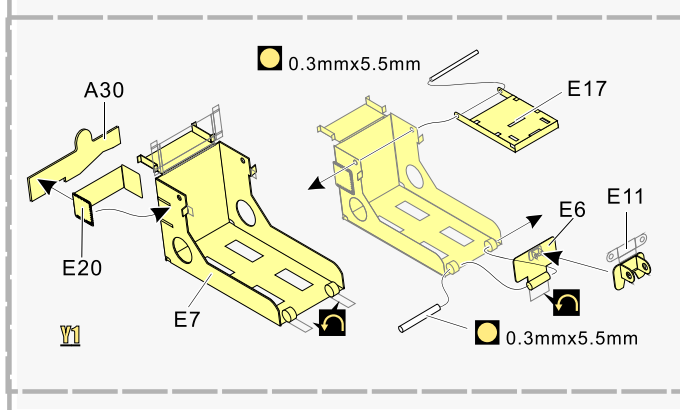
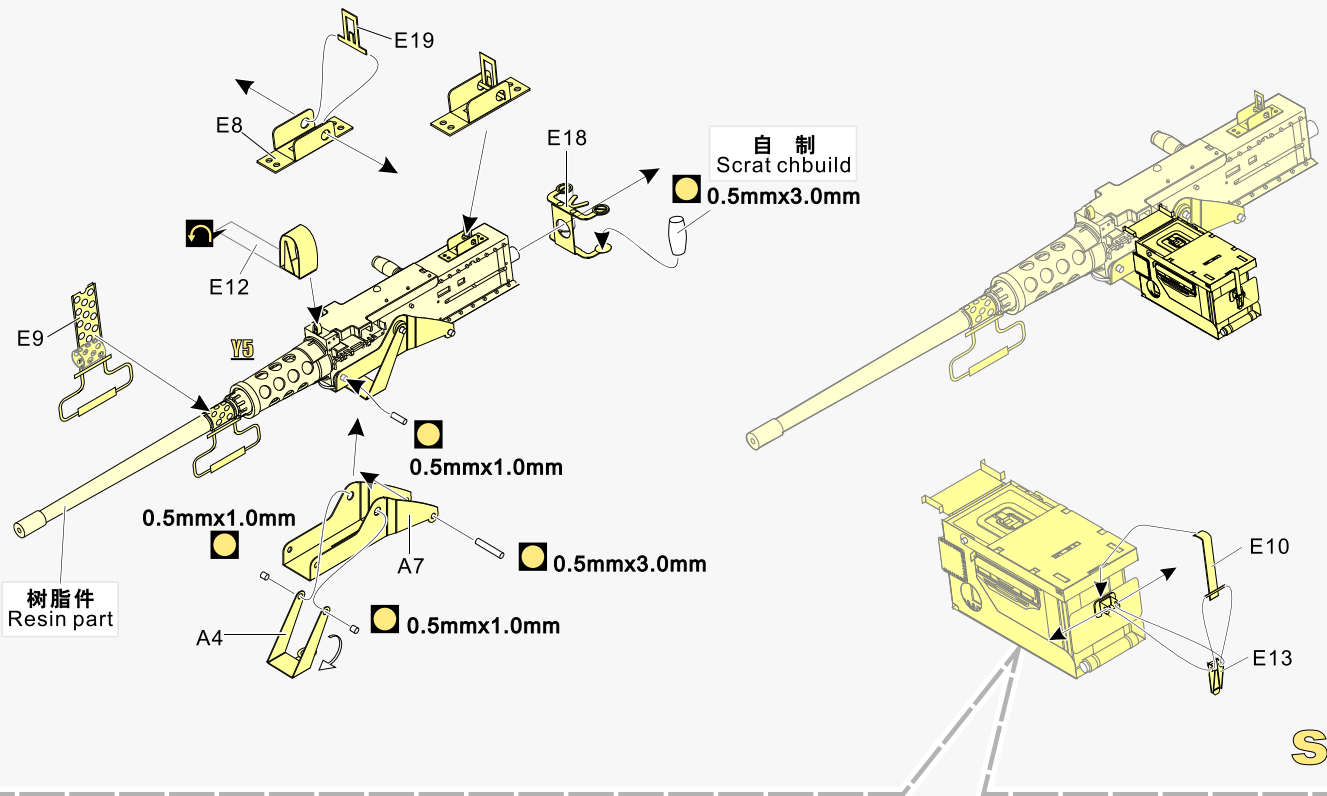
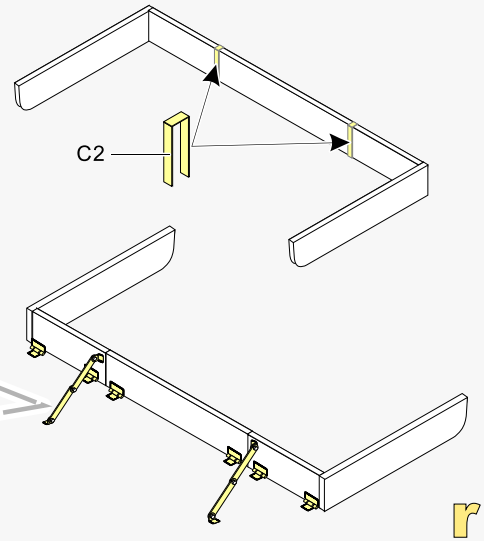
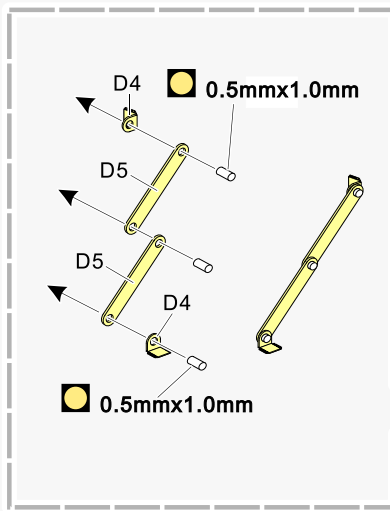
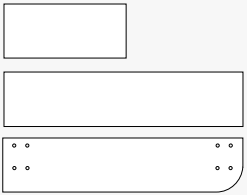

1/35 MILITARY MINIATURE VEHICLE UPGRADE SERIES PE35244

树脂件  
Resin part

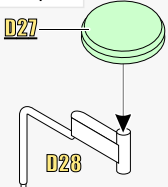

⚠  
安装指示参考套件  
说明书  
Refer to kit instruction  
for installation

t

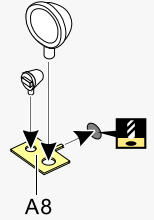

A8

u

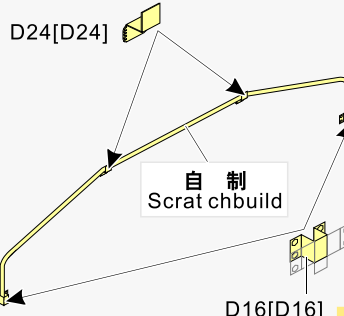

自制  
Scrat chbuild

D16[D16]

v

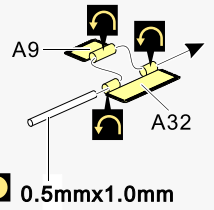

0.5mmx1.0mm

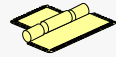

w

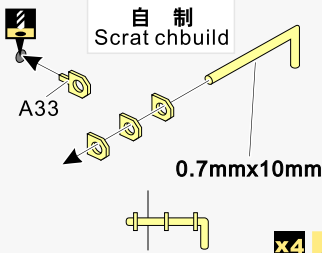

自制  
Scrat chbuild

A33

0.7mmx10mm

x4 X

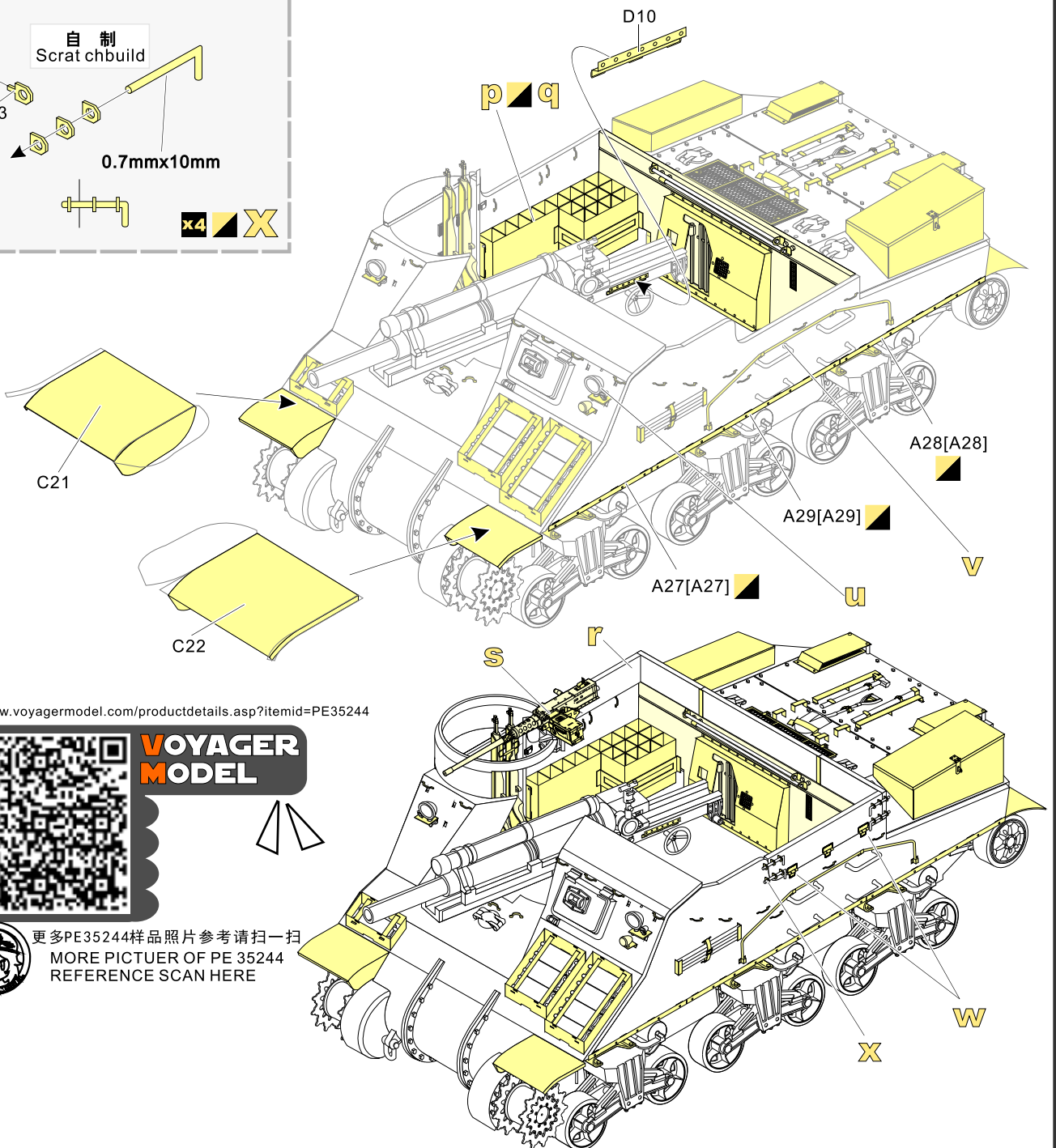

[Http://www.voyagermodel.com/productdetails.asp?itemid=PE35244](http://www.voyagermodel.com/productdetails.asp?itemid=PE35244)



**VOYAGER  
MODEL**



更多PE35244样品照片参考请扫一扫  
MORE PICTUER OF PE 35244  
REFERENCE SCAN HERE