

# 648 638 Tempest Mk.II gun bays

for Eduard / Special Hobby kit - pro stavěbnici Eduard / Special Hobby

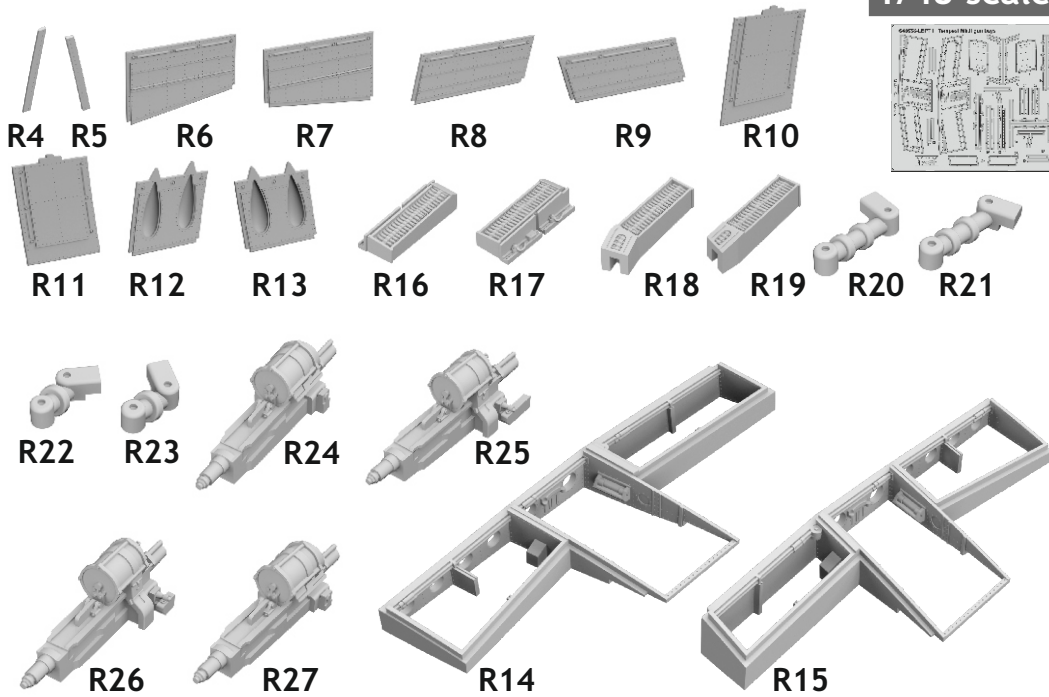

1/48 scale



### COLOURS

GSI Creos (GUNZE)			Mr.METAL COLOR	
AQUEOUS	Mr.COLOR			
H 8	C 8	SILVER	MC213	STAINLESS
			MC214	DARK IRON
			MC219	BRASS

This product contains metal and resin detail parts for upgrading scale plastic models. When selecting this set make sure that it is for the kit mentioned in product name as these sets are made specifically for that kit. When upgrading the model some cutting or corrections may be necessary for parts to fit accurately. **WARNING!** This set contains small and sharp parts. Work carefully in a ventilated and well-lit room. Safety glasses are recommended. This product is not suitable for children below 14 years of age.

Tento výrobek obsahuje leptané a odlévané detaily pro úpravu a vylepšení plastického modelu. Při výběru sady kovových detailů zkontrolujte, zda je určena pro model, který chcete upravit. Model, pro který je sada určena, je uveden u názvu výrobku. Pro přesnou aplikaci kovových a odlévaných dílů může být zapotřebí upravit díly upravovaného modelu. **POZOR!** Sada obsahuje malé ostré díly. Pracujte ve větrané a dobře osvětlené místnosti. Doporučujeme použití ochranných brýlí. Tento výrobek není vhodný pro děti mladší 14 let.

**eduard**  
435 21 Obrnice 170  
Czech Republic  
www.eduard.com

www.eduard.com  
24,95



# 648 638 Tempest Mk.II gun bays

for Eduard / Special Hobby kit - pro stavěbnici Eduard / Special Hobby

1/48

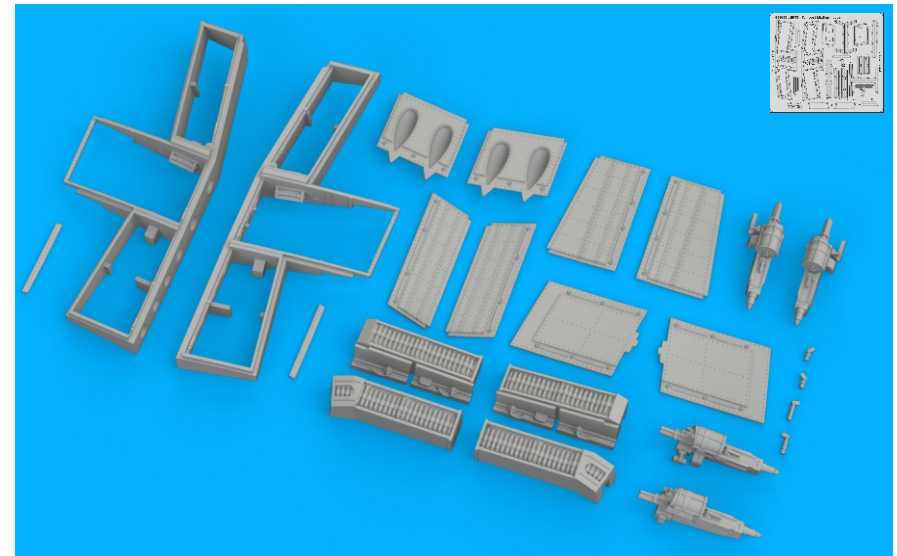
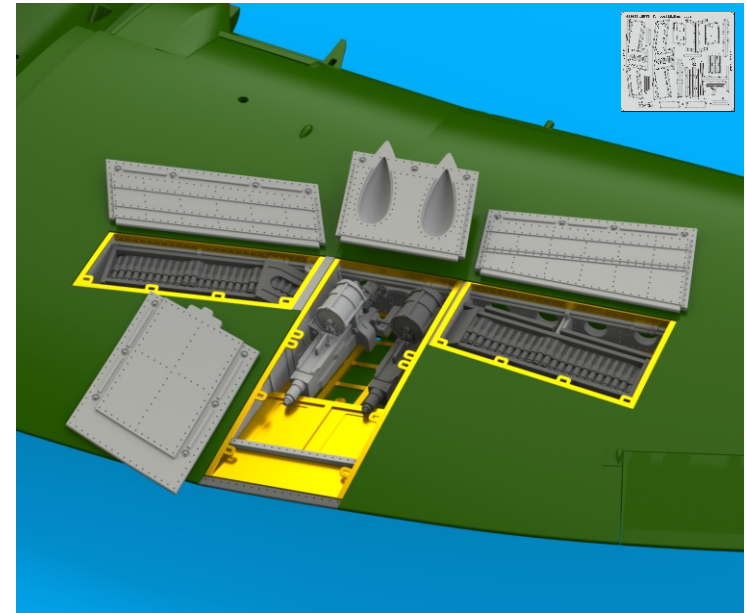

**BEST ~~BRASS~~ RESIN AROUND!**

1

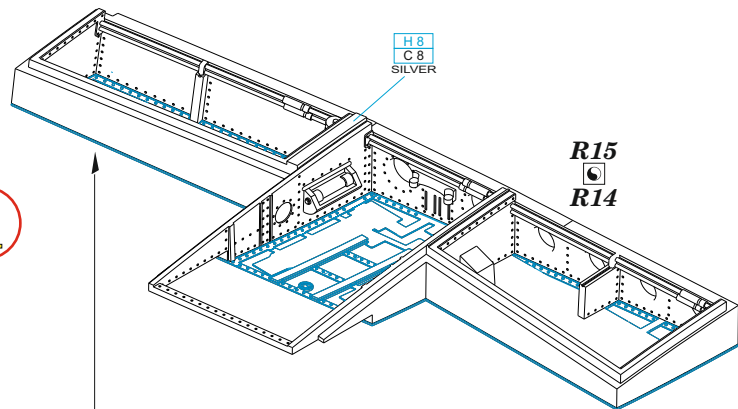

2

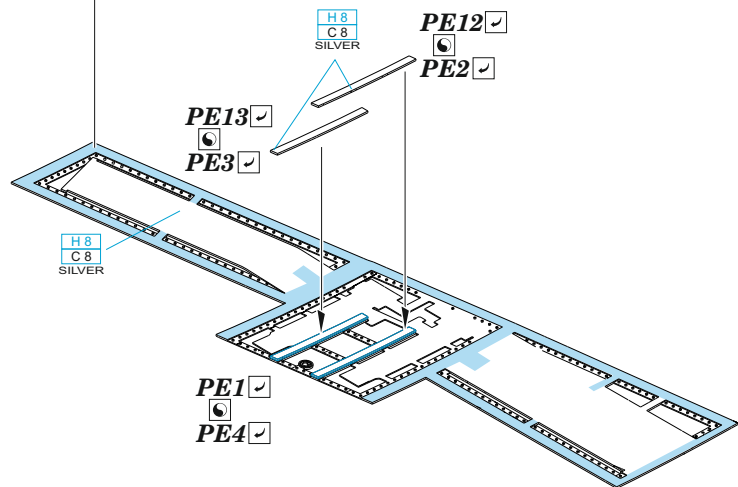
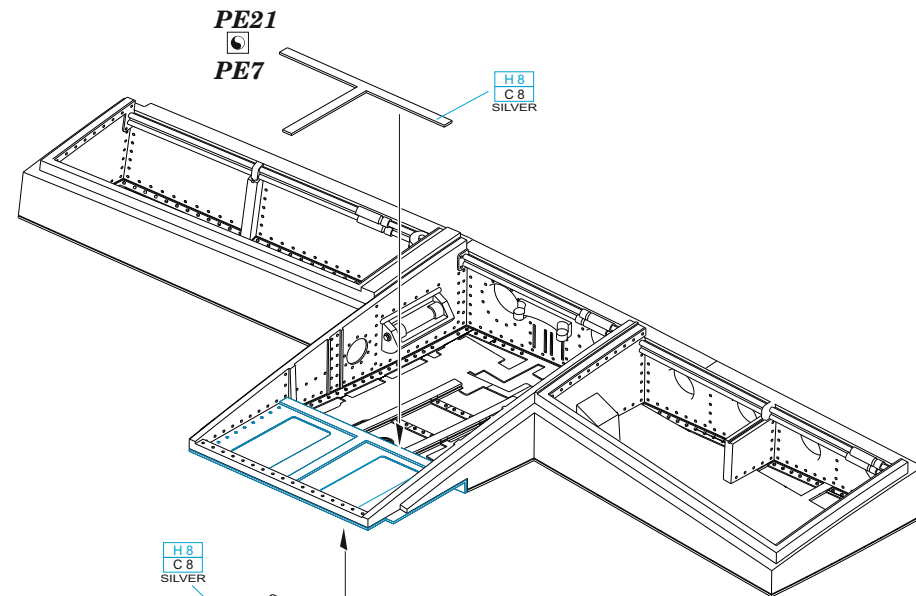

3

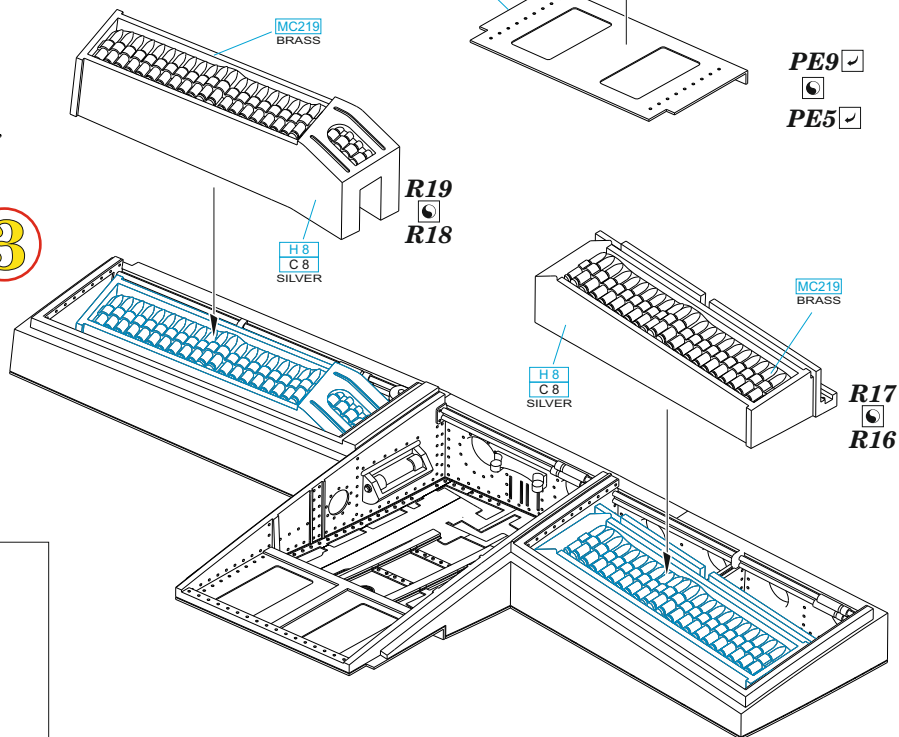

**RIGHT SIDE:** R5, R7, R9, R11, R13, R15, R17, R19, R23, R25, R27, PE1, PE8, PE9, PE12, PE13, PE14, PE15, PE16, PE17, PE20, PE21, PE24, PE25

**LEFT SIDE:** R4, R6, R8, R10, R12, R14, R16, R18, R21, R20, R22, R24, R26, PE2, PE3, PE4, PE5, PE6, PE7, PE10, PE11, PE18, PE19, PE22, PE23, PE26

**!** Do not use parts PE25, PE26, R5, R4 if PE Set Cat.No. 481064 is used.

	REMOVE ODSTRANIT		BEND OHNOUT
	GRIND OBROUSIT		OPTION VOLBA
	DRILL HOLE VRTAT OTVOR		REPLACE NAHRADIT
	SYMMETRICAL ASSEMBLY SYMETRICKÁ MONTÁŽ		
	SCRIBE THE PANEL AND HOLES RYTI		
	REVERSE SIDE OTOČIT		

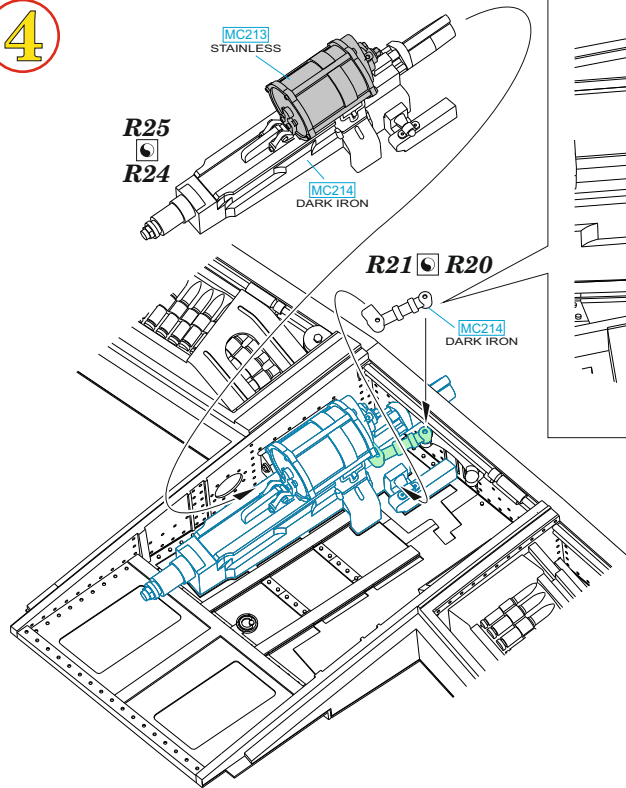

4



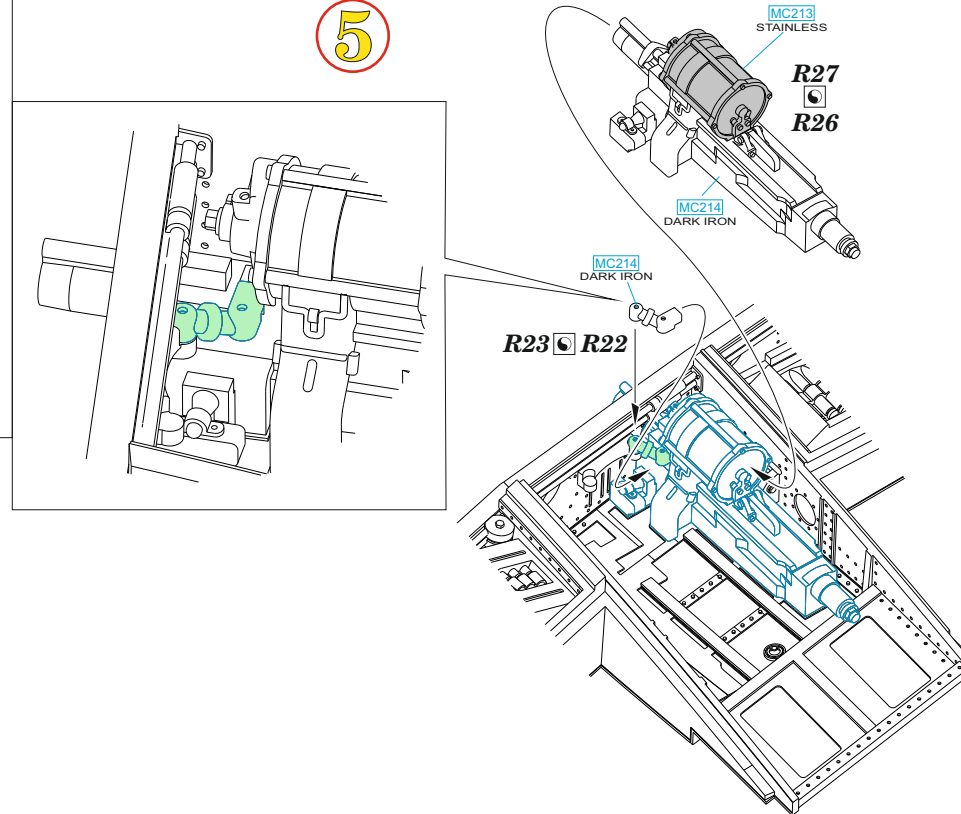

5

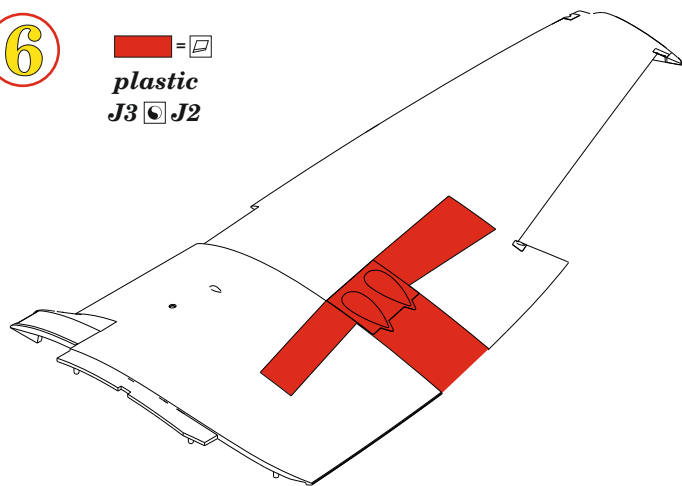

6

 =   
 plastic  
 J3 J2



 =   
 plastic  
 J1

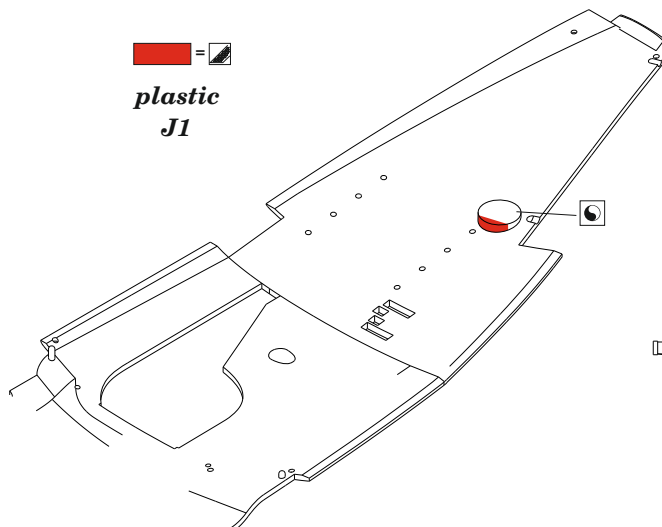

 If Brassin set Cat.No. 648641 or plastic rockets are used together with this set.

 = 

 1 mm

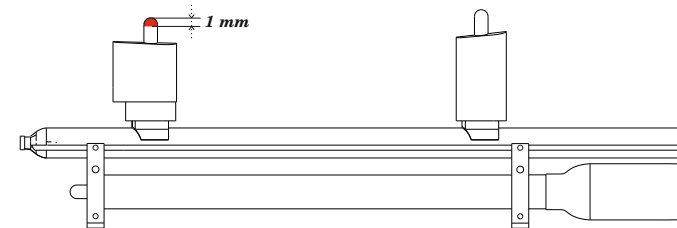

7

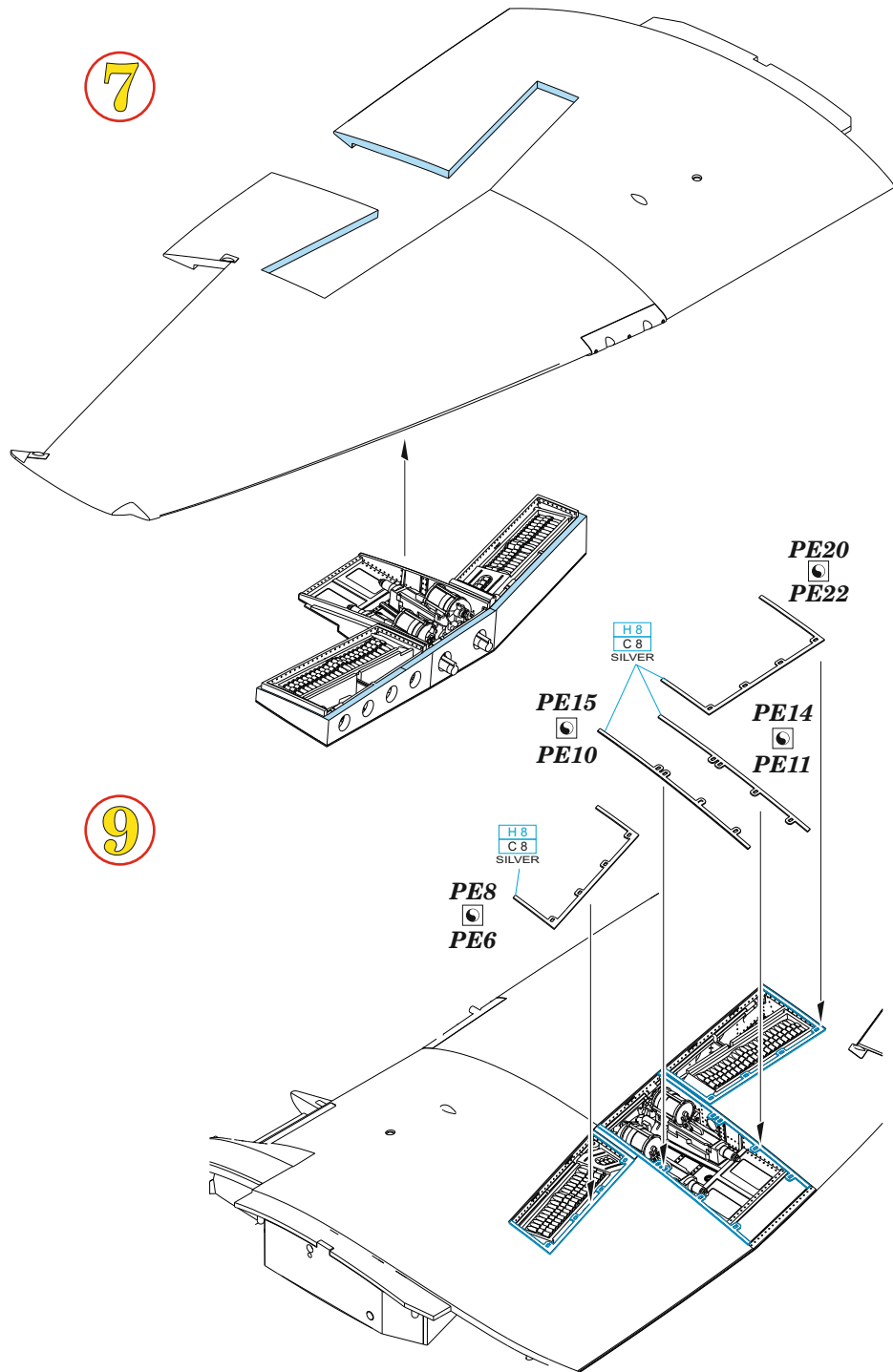

9

8

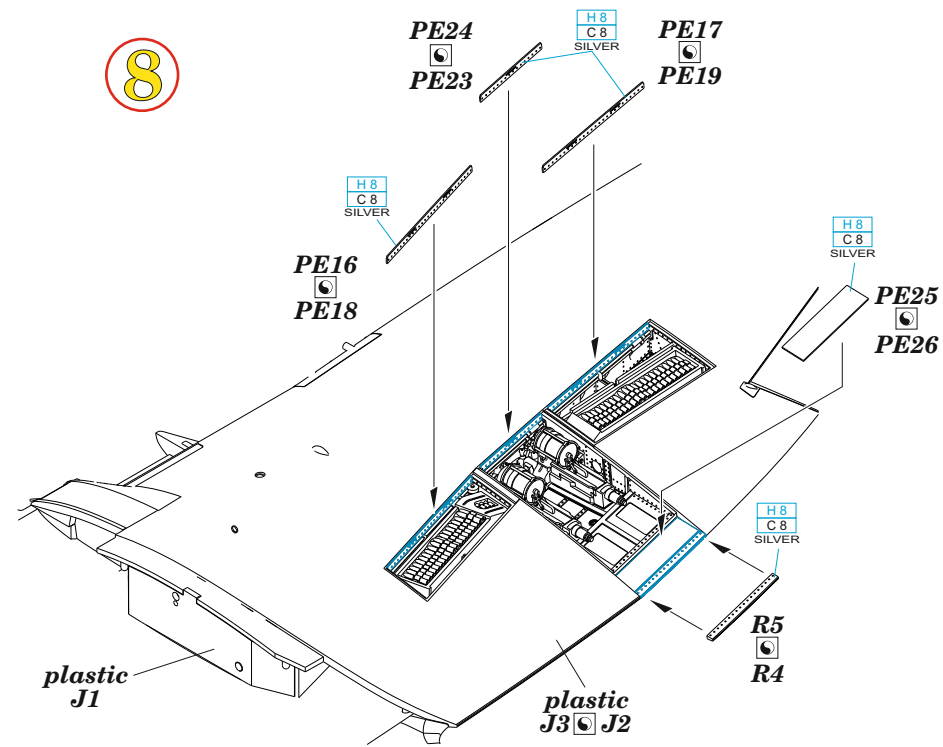

INNER SURFACE OF THE GUN BAY COVERS

