

**eduard**  
**Express Mask**

# TORNADO

The die-cut mask for accurate canopy frame painting of the  
*Italeri 1/48 KIT*

## XF 082

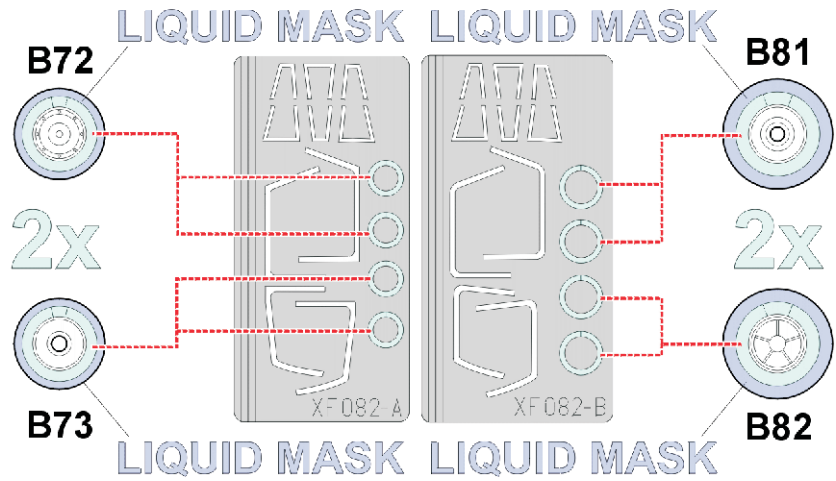
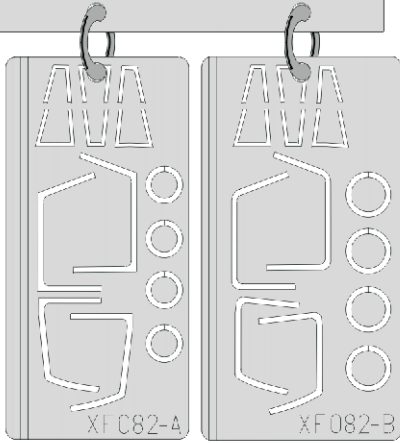

1.) D55

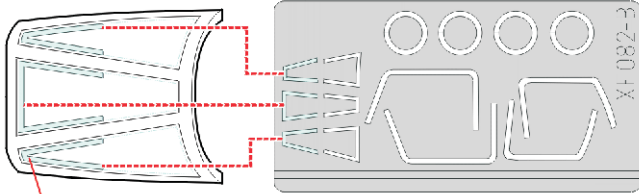

2.)

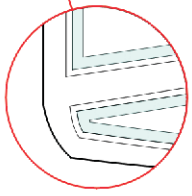
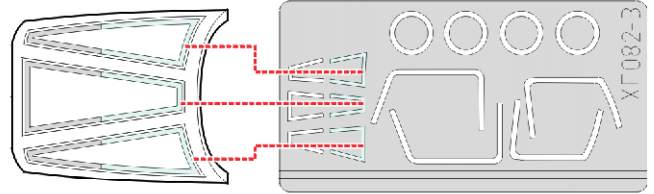

3.) INTERIOR COLOR

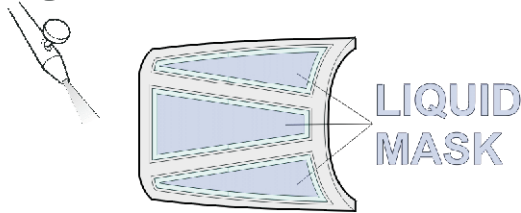

4.) RUBBER COLOR

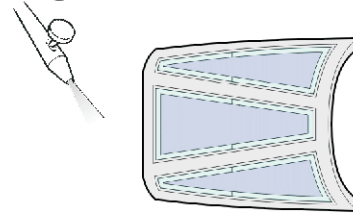

5.)

REMOVE MASK

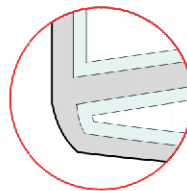

6.)

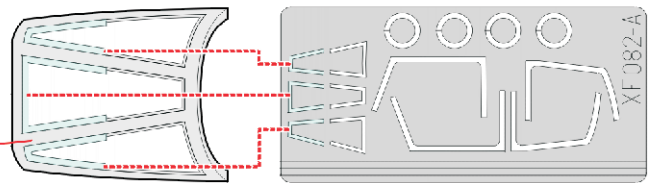

7.)

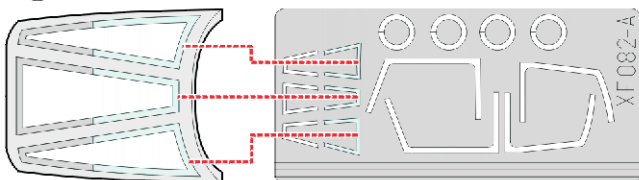

8.)

CAMOUFLAGE COLOR

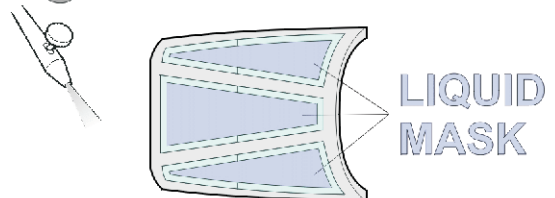

1.) D54

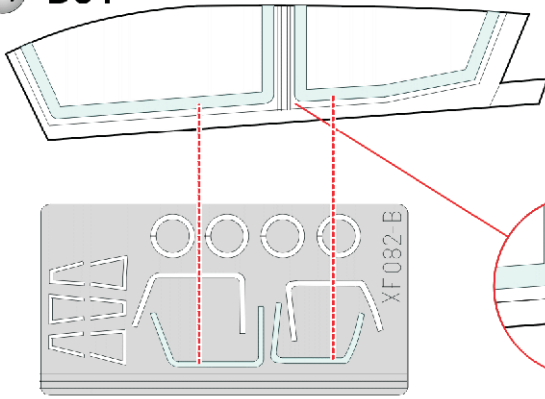

2.)

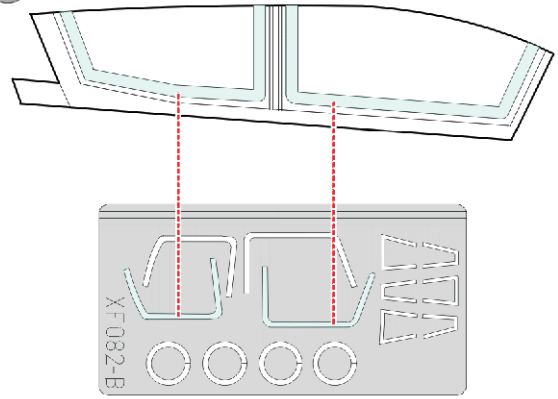

3.) INTERIOR COLOR

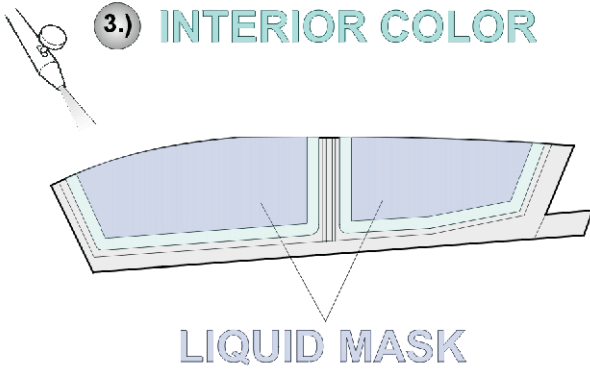

4.) RUBBER COLOR

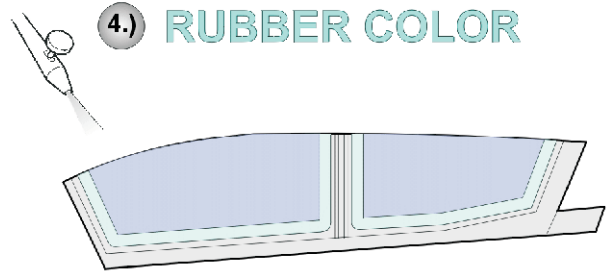

5.) REMOVE MASK

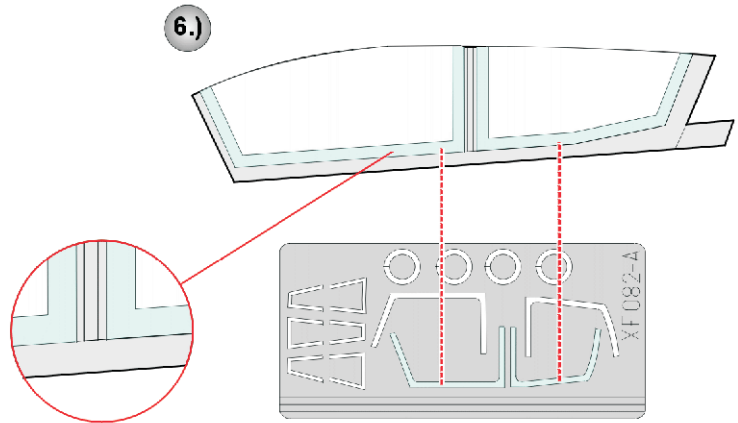

7.)

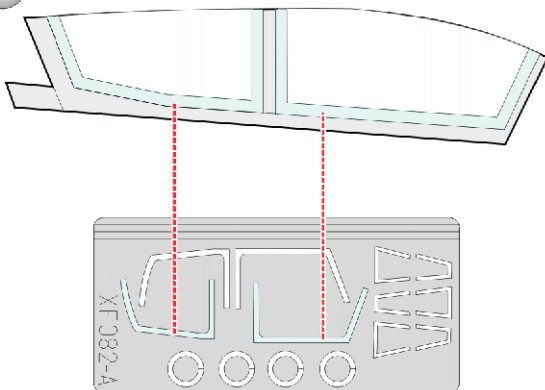

8.) CAMOUFLAGE COLOR

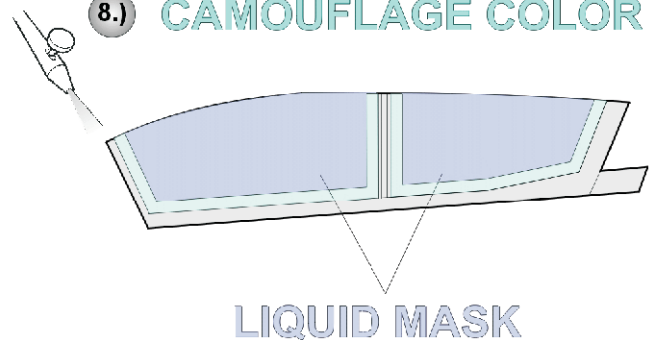

**REFERENCES:** Replic #105 / Mai 2000  
 Aeroguide #21; #24  
 Verlinden Lock On #12