

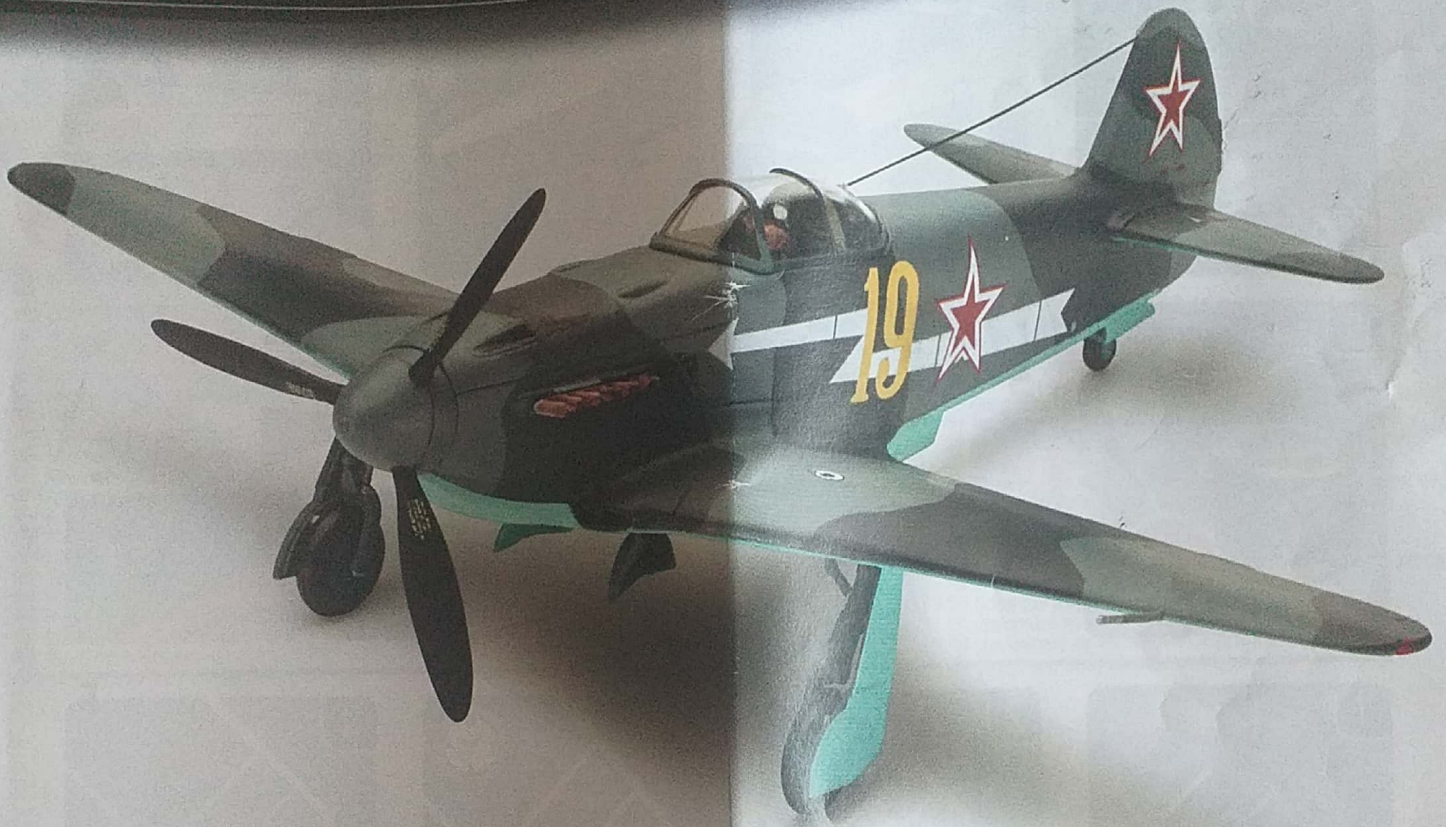

03894-0379

LEVEL 3  
1 2 3 4 5

# Yakovlev Yak-3

Beiliegenden Sicherheitstext beachten / Please note the enclosed safety advice

- DE Beiliegenden Sicherheitstext beachten und nachschlagbereit halten.
- GB Please note the enclosed safety advice and keep safe for later reference.
- FR Respecter les consignes de sécurité ci-jointes et les conserver à portée de main.
- NE Houdt u aan de bijgaande veiligheidsinstructies en hou deze steeds bij de hand.
- IT Seguire le avvertenze di sicurezza allegate e tenerle a portata di mano.
- ES Observar y siempre tener a disposición este texto de seguridad adjunto.
- PT Ter em atenção o texto de segurança anexo e guardá-lo para consulta.

- DK Overhold vedlagte sikkerhedsanvisninger og hav dem liggende i nærheden.
- NO Ha alltid vedlagt sikkerhetstext klar til bruk.
- BE Beakta bifogad säkerhetstext och håll den i beredskap.
- H Huomioi ja säilytä oheiset varoitukset.
- RU Соблюдать технику безопасности, сохранить инструкцию для дальнейших обращений.
- PL Przestrzegać załączanego tekstu dotyczącego bezpieczeństwa i mieć go zawsze pod ręką.
- CZ Dodržujte tento příložený bezpečnostní text a mějte ho po ruce.
- HU A mellékelt biztonsági szöveget vegye figyelembe és tartson a közelében.

- SK Rešpektujte priložený bezpečnostný text a uchovajte ho pre budúce použitie.
- RO Respectați textul de siguranță atașat și păstrați-l la îndemână.
- BG Спазвайте приложението текст за безопасност и го дръжте под ръка за справки.
- SI Prilolena varnostna navodila izvajajte in jih hranite na vsem dostopnem mestu.
- GR Λάβετε υπόψη σας το συννημένο κείμενο ασφαλείας και φυλάξτε το ώστε να ανατρέχετε σε αυτό όποτε χρειάζεται.
- TR Ekteki güvenlik talimatlarını dikkate alıp, bakabileceğiniz bir şekilde muafaza ediniz.

# Benötigte Farben / Required colours

- FR Peintures nécessaires
- NL Benodigde kleuren
- IT Colori necessari
- ES Colores necesarios
- PT Cores necessárias
- DK Nødvendige farver
- NO Nødvendige farger
- SE Erforderliga färger
- FI Tarvittavat värit
- RU Необходимые краски
- PL Potrzebne kolory
- CZ Potřebné barvy
- SZ Szükséges színek
- HU Požadované farby
- RO Culori necesare
- BG Необходими цветове
- SI Potrebne barve
- GR Απαιτούμενα χρώματα
- TR Gerekli renkler

57 **A**

- DE Grau matt
- GB Grey matt
- FR Gris mat
- NL Grijs mat
- IT Grigio opaco
- ES Gris mate
- PT Cinzento mate
- DK Grå mat
- NO Grå matt
- SE Grå matt
- FI Harmaa matta
- RU Серый матовый
- PL Szary matowy
- CZ Seda matný
- SZ Sürke, fénytelen
- HU Szürke, fénytelen
- RO Siva matny
- BG Гри мат
- SI Sivo matovo
- GR Siva mat
- TR Gri mat

74 **B**

- DE Geschützgrau matt
- GB Battleship grey matt
- FR Gris canon mat
- NL Kanongrijs mat
- IT Grigio cannone opaco
- ES Gris acero mate
- PT Cinza aço mate
- DK Militærgrå mat
- NO Militærgrå matt
- SE Militærgrå matt
- FI Kanongrii matta
- RU Сополно-серый матовый
- PL Szary bazaltowy matowy
- CZ Oloveně sedivá matný
- SZ Agyi szürke, fénytelen
- HU Delovo siva matny
- RO Gri-tun mat
- BG Оръжейносиво матово
- SI Topovsko-siva mat
- GR Μολυβί ανοιχτό ματ
- TR Koyu metal griisi mat

20%

05

**C**

55

80%

- DE Weiß matt
- GB White matt
- FR Blanc mat
- NL Wit mat
- IT Bianco opaco
- ES Blanco mate
- PT Branco mate
- DK Hvid mat
- NO Hvit matt
- SE Vit matt
- FI Valkoinen matta
- RU Белый матовый
- PL Biały matowy
- CZ Bílá matný
- HU Fehér, fénytelen
- SZ Biela matný
- RO Alb mat
- BG Бяло матово
- SI Bela mat
- GR Απρό ματ
- TR Beyaz mat

+

- DE Lichtgrün matt
- GB Light green matt
- FR Vert clair mat
- NL Lichtgroen mat
- IT Verde chiaro opaco
- ES Verde claro mate
- PT Verde claro mate
- DK Lysegrøn mat
- NO Lys grønn matt
- SE Ljusgrön matt
- FI Vaaleanvihreä matta
- RU Светло-зелёный матовый
- PL Rozświetlony zielony matowy
- CZ Světla zelená matný
- HU Halványzöld, fénytelen
- SZ Svetlo zelená matný
- RO Verde-deschis mat
- BG Лъчистозелено матово
- SI Svetlo-zelena mat
- GR Πράσινο ανοιχτό ματ
- TR Açık yeşil mat

09 **D**

- DE Anthrazit matt
- GB Anthracite matt
- FR Anthracite mat
- NL Antraciet mat
- IT Antracite opaco
- ES Antracita mate
- PT Antracite mate
- DK Antracitgrå mat
- NO Antrasitt matt
- SE Antracitgrå matt
- FI Antrasitinharmaa matta
- RU Антрацит матовый
- PL Antracyt matowy
- CZ Antracitová Seda matný
- HU Antracit, fénytelen
- SZ Čierna uhľová matný
- RO Antracit mat
- BG Антрацит матово
- SI Antracit mat
- GR Γκρι ανθρακί ματ
- TR Antrazit mat

83 **E**

- DE Rost matt
- GB Rust matt
- FR Rouille mat
- NL Roest mat
- IT Ruggine opaco
- ES óxido mate
- PT Ferrugem mate
- DK Rust mat
- NO Rust matt
- SE Rost matt
- FI Ruoste matta
- RU Ржавый матовый
- PL Rdzawy matowy
- CZ Rezavá matný
- HU Rozsdaszínú, fénytelen
- SZ Hrdzavá matný
- RO Ruginiu mat
- BG Ръжда матово
- SI Rjasta mat
- GR Χρώμα σκουριάς ματ
- TR Pas rengi mat

362 **F**

- DE Schilfgrün seidenmatt
- GB Greyish green silk matt
- FR Vert jonc satiné mat
- NL Rietgroen zijdemat
- IT Verde canna opaco satinato
- ES Verde grisáceo mate satinado
- PT Verde cinza mate sedoso
- DK Grågrøn silkematt
- NO Grågrønn silkematt
- SE Grågrön sidenmatt
- FI Harmaanvihreä silkimatta
- RU Зелёный тростник шелковисто-матовый
- PL Zielony trzciniowy jedwabście matowy
- CZ Sedivozelená jemně matný
- HU Nádzöld, fakóselymes
- SZ Sivozelená hodvábné matný
- RO Verde-trestie satinat
- BG Тръстиковозелено коприненоматово
- SI Trstje-zelena svilenomat
- GR Πράσινο-υκρί σατινέ
- TR Gri yeşil ipeksi mat

48 **G**

- DE Seegrün matt
- GB Sea green matt
- FR Vert mer mat
- NL Zeegroen mat
- IT Verde mare opaco
- ES Verde mar mate
- PT Verde mar mate
- DK Havgrøn mat
- NO Sjøgrønn matt
- SE Havsgrün matt
- FI Merenvihreä matta
- RU Морская волна матовый
- PL Morska zielen matowy
- CZ Mořská zelená matný
- HU Tengerzöld, fénytelen
- SZ Morska zelená matný
- RO Verde-marin mat
- BG Морскозелено матово
- SI Jezersko-zelena mat
- GR Πράσινο θαλά ματ
- TR Deniz yeşili mat

35 **H**

- DE Hautfarbe matt
- GB Flesh matt
- FR Couleur chair mate
- NL Huidkleur mat
- IT Color pelle opaco
- ES Carne mate
- PT Cor da pele mate
- DK Hudfarvet mat
- NO Hudfarge matt
- SE Hudfärg matt
- FI Ihonväri matta
- RU Телесный матовый
- PL Cielisty matowy
- CZ Kůže matný
- HU Bőrszínú, fénytelen
- SZ Culoarea pielii mat
- RO Telesen cвят матово
- SI Kožne-barve mat
- GR Χρώμα δέρματος ματ
- TR Ten rengi mat

86 **I**

- DE Khakibraun matt
- GB Khaki brown matt
- FR Kaki mat
- NL Khaki mat
- IT Marrone cachi opaco
- ES Caqui mate
- PT Castanho caqui mate
- DK Khakibrun mat
- NO Khakibrun matt
- SE Khakibrun matt
- FI Oliivinvruskea matta
- RU Коричневый хаки матовый
- PL Khaki matowy
- CZ Olivová hnědá matný
- HU Kekiszínú, fénytelen
- SZ Olivová hnědá matný
- RO Maro măsliniu mat
- BG Каки матово
- SI Kaki-rjava mat
- GR Καφέ-λαδί ματ
- TR Zeytin kahvesi mat

36 **J**

- DE Karminrot matt
- GB Carmine red matt
- FR Rouge carmin mat
- NL Karminrood mat
- IT Rosso carminio opaco
- ES Rojo carmin mate
- PT Vermelho carmim mate
- DK Karminrød mat
- NO Karminrød matt
- SE Karminrød matt
- FI Karmininpunainen matta
- RU Карминный матовый
- PL Karminowa czerwien matowy
- CZ Karminová červená matný
- HU Karminpiros, fénytelen
- SZ Karminovo červená matný
- RO Rosu-carmin mat
- BG Карминовочервено матово
- SI Karminsko-rdeča mat
- GR Αλκό κόκκινο ματ
- TR Karmen kırmızısı mat

89 **K**

- DE Beige matt
- GB Beige matt
- FR Beige mat
- NL Beige mat
- IT Beige opaco
- ES Beige mate
- PT Beige mate
- DK Beige mat
- NO Beige matt
- SE Beige matt
- FI Beige matta
- RU Бежевый матовый
- PL Beżowy matowy
- CZ Běžová matný
- HU Bézs, fénytelen
- SZ Běžová matný
- RO Bej mat
- BG Бежово матово
- SI Bež mat
- GR Μπεζ ματ
- TR Bej mat

95% 5%

19x 1x

DE Beispiel: mischen  
GB Example: mixing  
FR Exemple: mélanger  
NL Voorbeeld: mengen  
IT Esempio: mescolare  
ES Ejemplo: mezclar  
PT Exemplo: misturar  
DK Eksempel: blanding  
NO Eksempel: blanding  
SE Exempel: blanda  
FI Esimerkki: sekoittaminen

RU Пример: смешивание  
PL Przykład: mieszać  
CZ Příklad: míchat  
HU Példa: keverés  
SK Příklad: miešanie  
RO Exemplu: amestecare  
BG Пример: смесване  
SI Primer: mešanje  
GR Παράδειγμα: αναμείγν  
TR Örnek: karıştırma

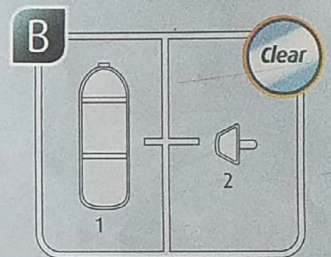
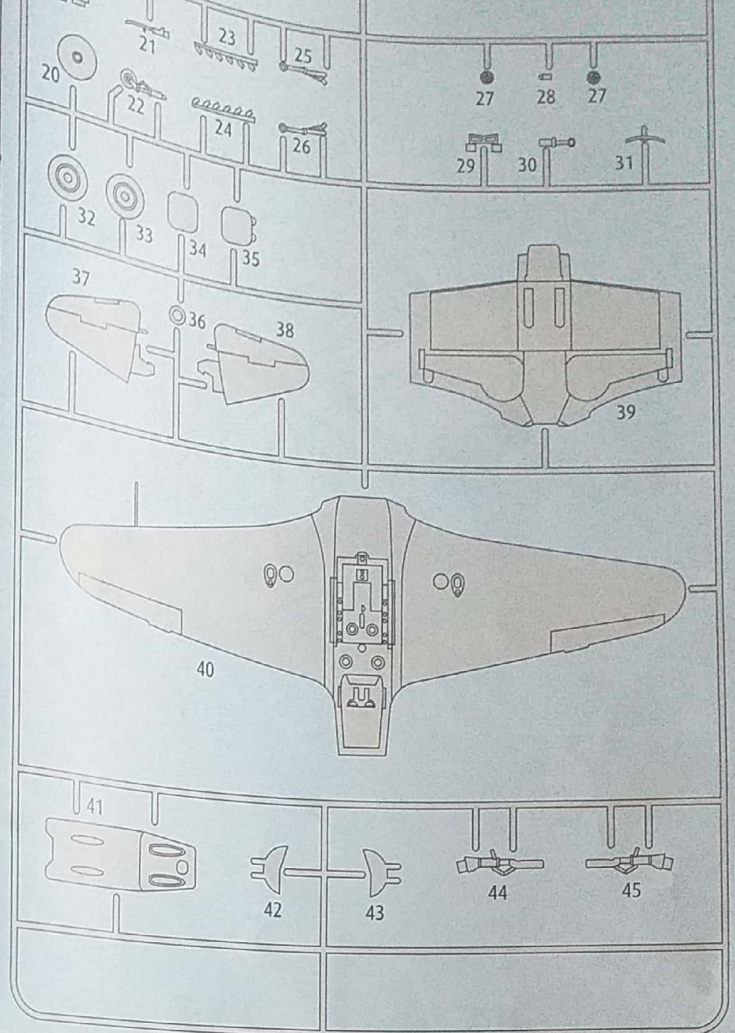
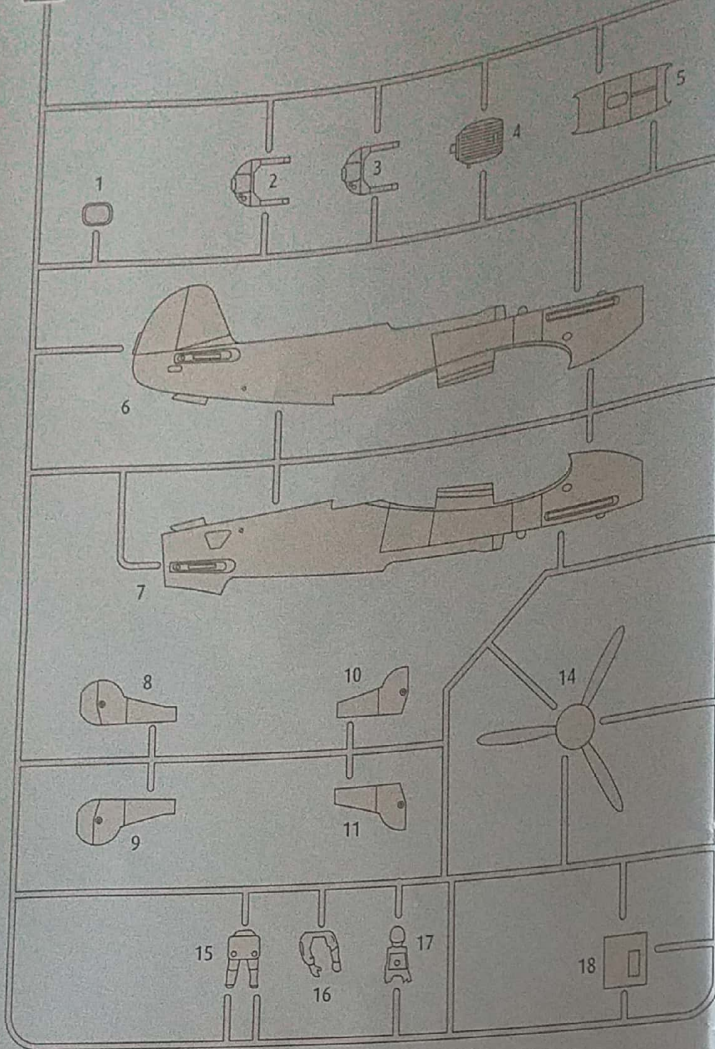

### Ersatzteile benötigt?

Kein Problem. Einfach den Revell-Service mit Angabe von Artikel- und Teilenummer kontaktieren. Entweder unter [service@revell.de](mailto:service@revell.de) oder Revell GmbH, Abteilung X, Henschelstr. 20-30, 32257 Bünde.\*

\*Wir bitten um Verständnis, dass eine Gewährleistung nur bei aktuellen Artikeln, die im Zeitraum der letzten 24 Monate erworben wurden, übernommen werden kann. Mit der Ersatzteil-Bestellung können Kosten z.B. für Verpackung und Versand entstehen. Ob diese Kosten anfallen wird im Vorfeld schriftlich durch unseren Service mitgeteilt. Das Angebot kann dann angenommen oder abgelehnt werden. Unfrei eingesandte Ersatzteil-Bestellungen werden von uns nicht angenommen! Dieser Direktservice gilt für die Länder Deutschland, Benelux, Österreich, Frankreich, Großbritannien. Ersatzteil-Bestellungen aus den übrigen Ländern werden über die jeweiligen Distributeure abgewickelt. Bitte kontaktieren Sie Ihren Händler.

### Besoin de pièces de rechange ?

Il vous suffit de contacter le service Revell et d'indiquer la référence de l'article et de la pièce. Soit en écrivant par mail à [france@revell.de](mailto:france@revell.de) (uniquement pour la France) ou par courrier à Revell GmbH, Département X, Henschelstr. 20-30, 32257 Bünde.\*

\*La garantie s'applique pour les articles présents au catalogue et achetés au cours des 24 derniers mois. Merci de votre compréhension. La commande de pièces de rechange peut donner lieu à des frais supplémentaires, par ex. pour l'emballage et le port. Notre service client vous en informera au préalable par écrit. Vous pourrez accepter ou refuser le devis. Nous n'acceptons pas les commandes de pièces de rechange envoyées sans affranchissement ! Ce service direct est valable pour les pays suivants : Allemagne, Benelux, Autriche, France, Grande-Bretagne. Les commandes de pièces en provenance d'autres pays sont traitées par les distributeurs correspondants. Veuillez contacter votre revendeur local.

### Need spare parts?

No problem. Contact Revell Service with the item number and part numbers you need: [service@revell.de](mailto:service@revell.de) or Revell GmbH, Unit 10, Old Airfield Industrial Estate, Cheddington Lane, Tring, Herts, HP23 4QR, Great Britain.\*

\*We request your understanding that a warranty can only be accepted for current articles which have been purchased in the last 24 months. Orders for spare parts may also be subject to costs for packaging and shipping. You will be notified in advance by our Service department if such costs are incurred. The offer can then be accepted or rejected. We will not be able to process any postal requests unless correct postage has been applied to mailing! This direct service applies to the countries: Germany, Benelux, Austria, France, and the United Kingdom. Spare part orders from other countries are processed by the local distributors. Please contact your dealer.

### Hebt u reserveonderdelen nodig?

Geen probleem! Neem eenvoudig contact op met de klantenservice van Revell en geef ons het artikel- en onderdeelnummer door. U kunt ons bereiken op [service@revell.de](mailto:service@revell.de) of per post: Revell GmbH, Afdeling X, Henschelstr. 20-30, 32257 Bünde.\*

\*Wij vragen uw begrip voor de omstandigheid, dat er alleen garantie kan worden geboden voor actuele artikelen, die in de afgelopen 24 maanden zijn gekocht. Met het bestellen van reserveonderdelen kunnen kosten gemoeid zijn, bijv. voor verpakking en verzending. U wordt vooraf schriftelijk door onze klantenservice op de hoogte gesteld als er kosten zouden ontstaan. Het aanbod kan dan worden aanvaard of afgewezen. Wij nemen geen ongefrankeerde bestellingen van reserveonderdelen aan! Deze rechtstreekse service wordt verleend in de landen: Duitsland, Benelux, Oostenrijk, Frankrijk en Groot-Brittannië. Bestellingen van andere landen worden afgehandeld via de betreffende distributeurs. Gelieve contact te nemen met uw verkoper.

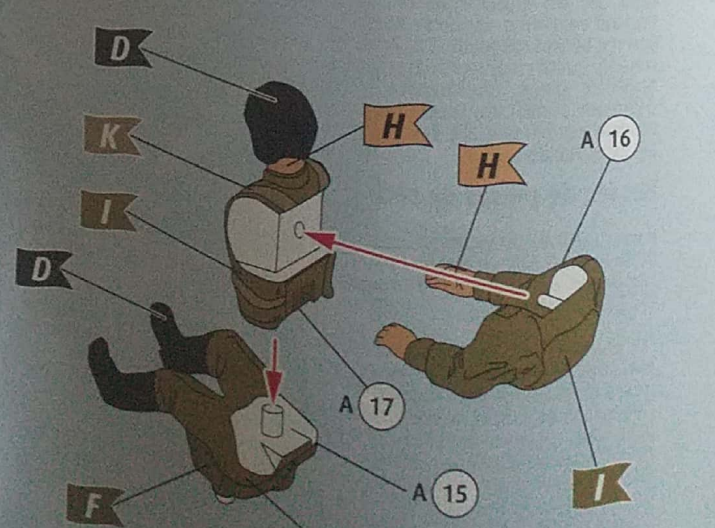
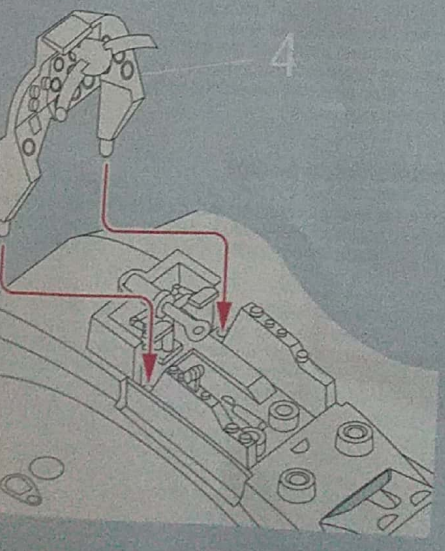
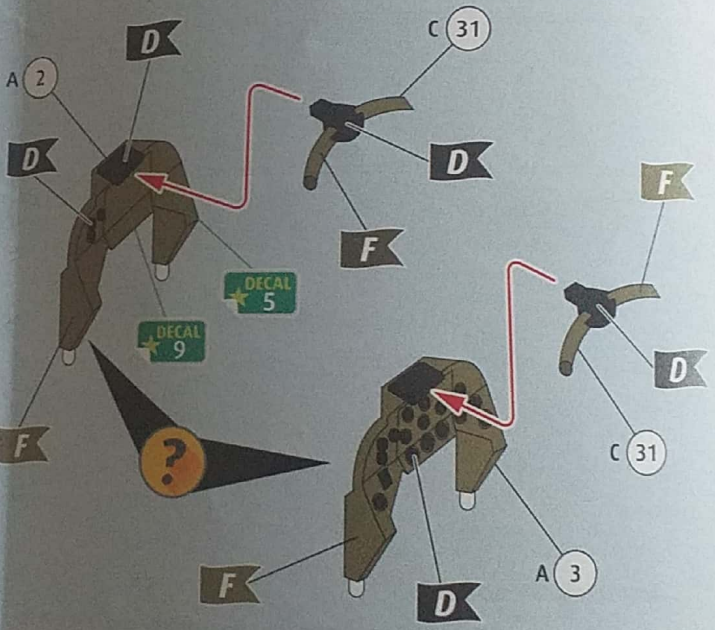
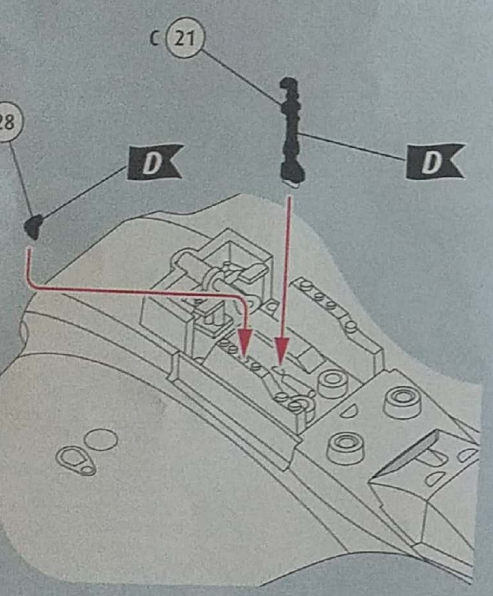
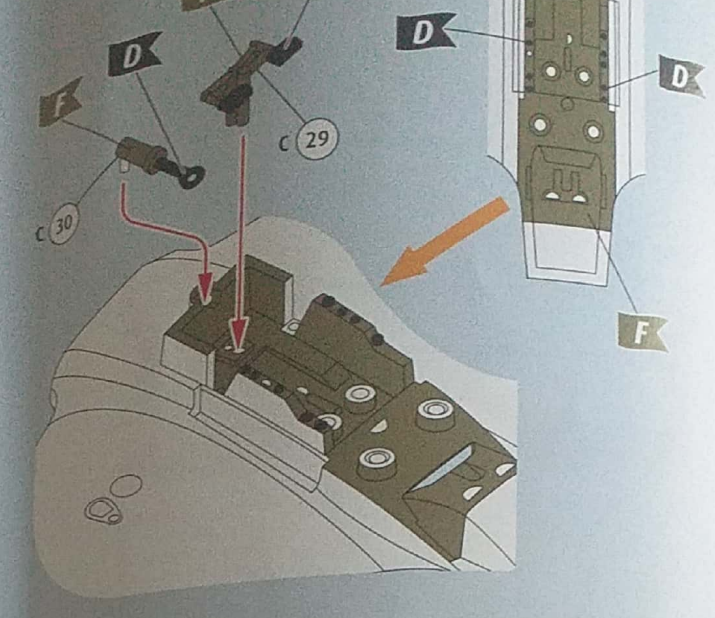
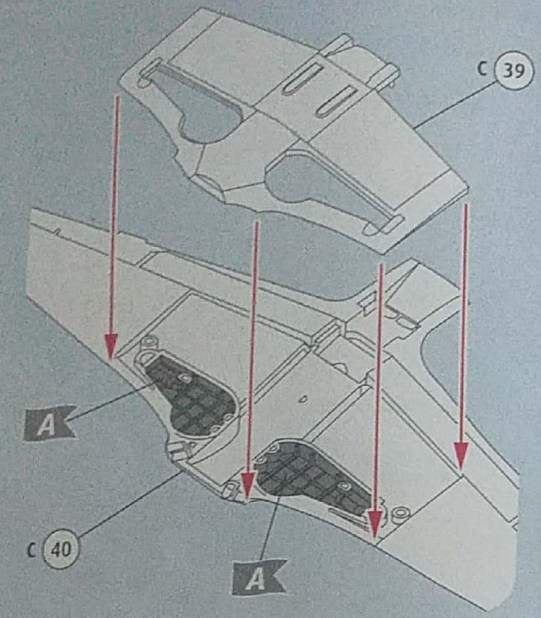

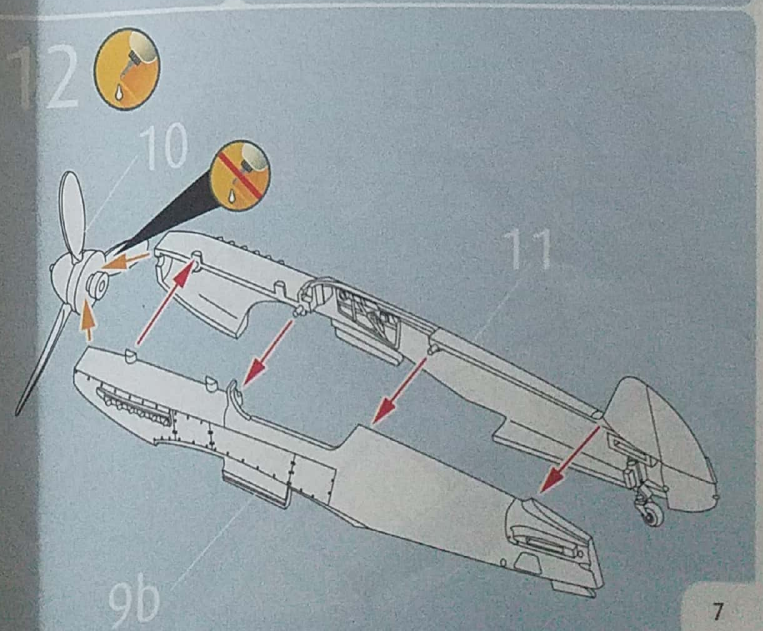
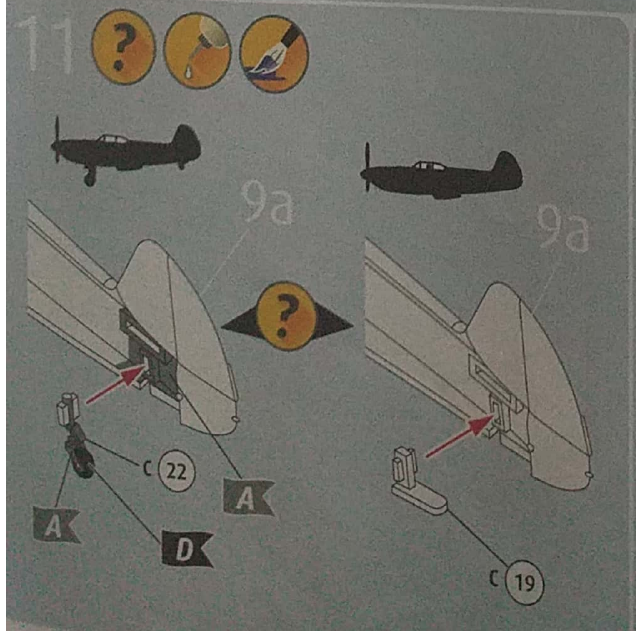
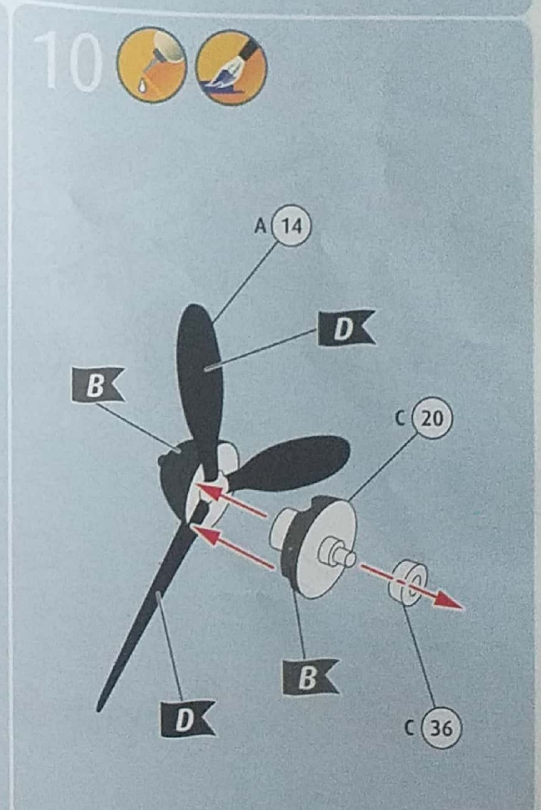
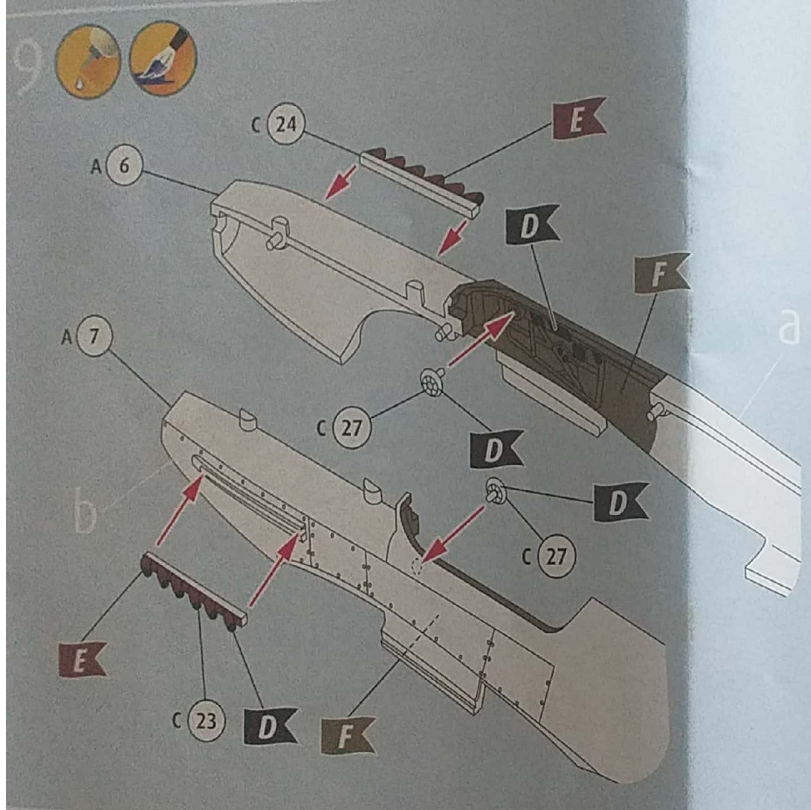
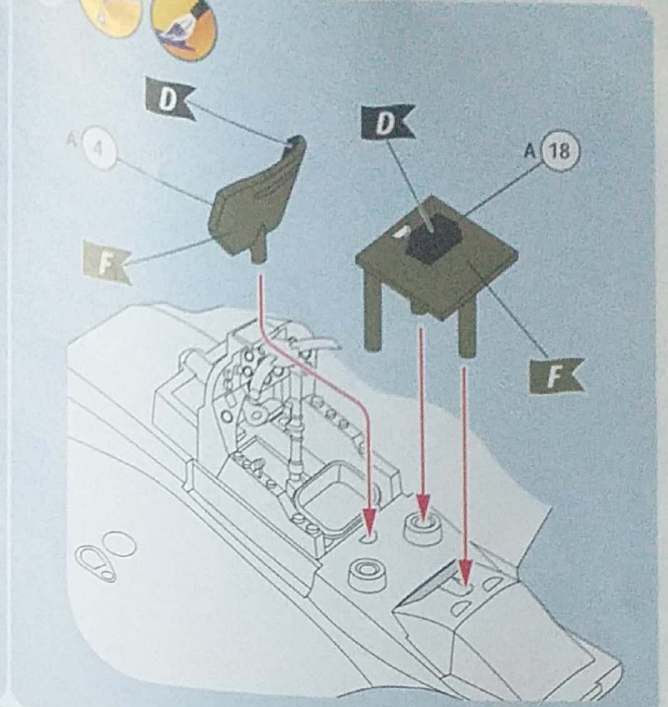
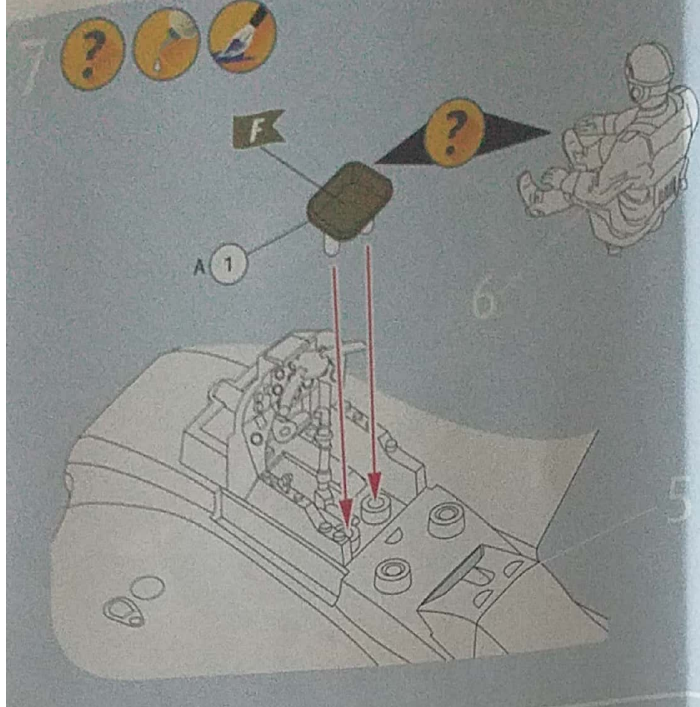

13 

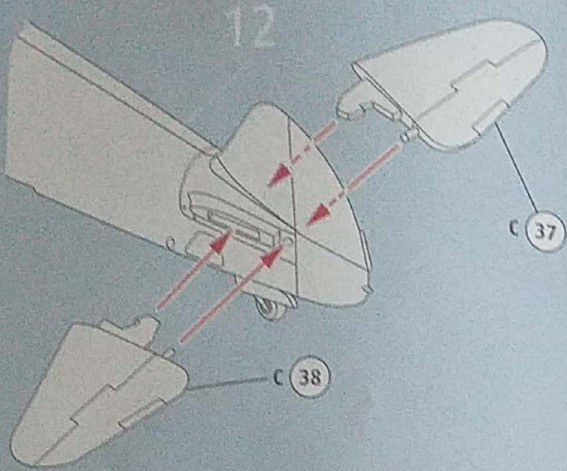

14 

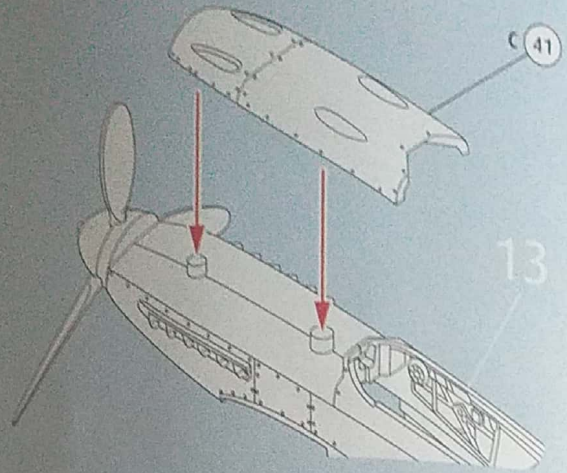

15 

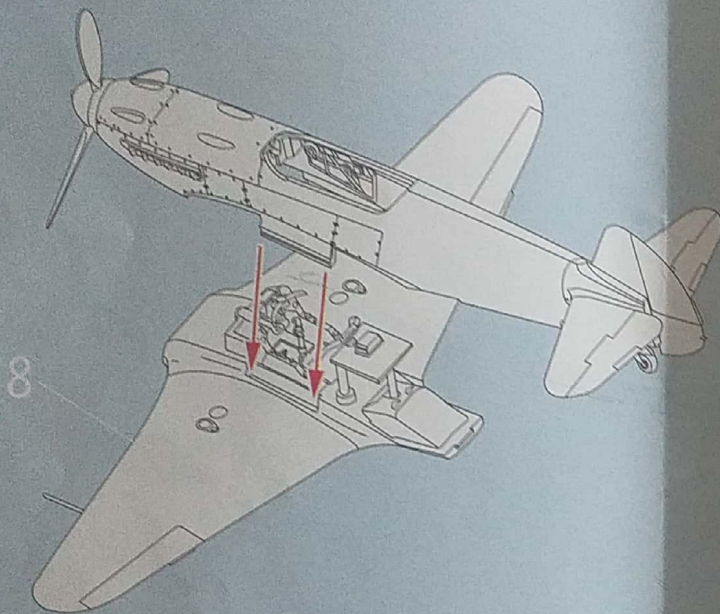

16 

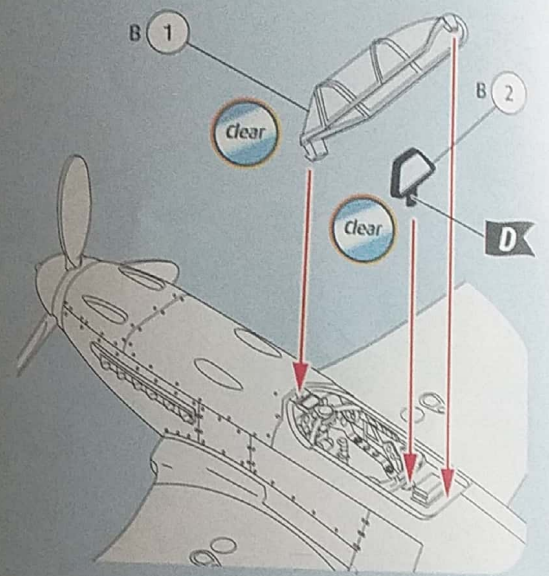

17 

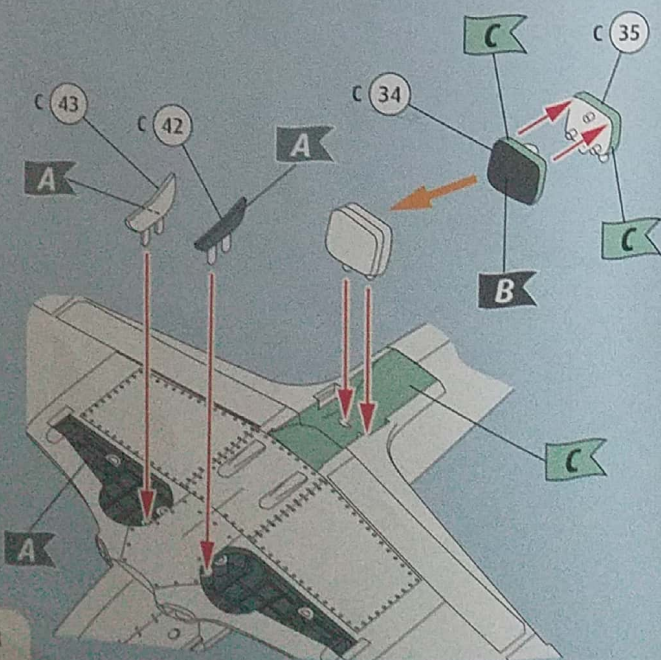

18 

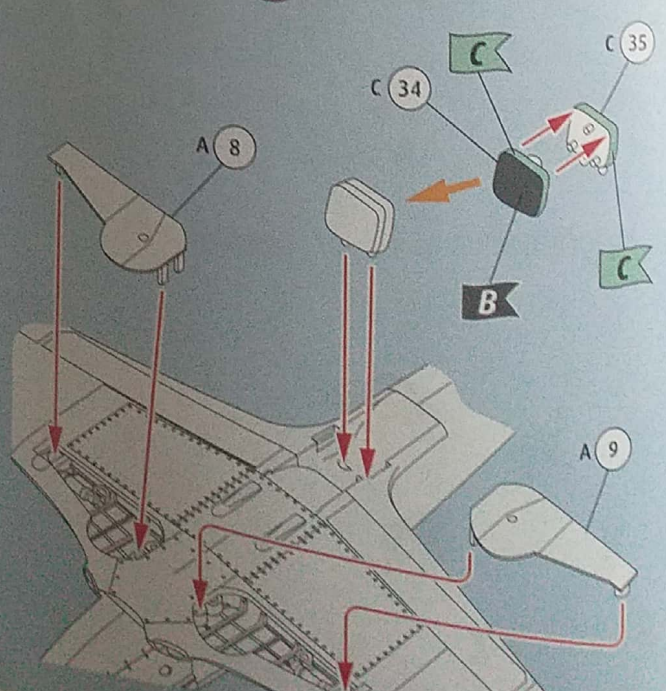

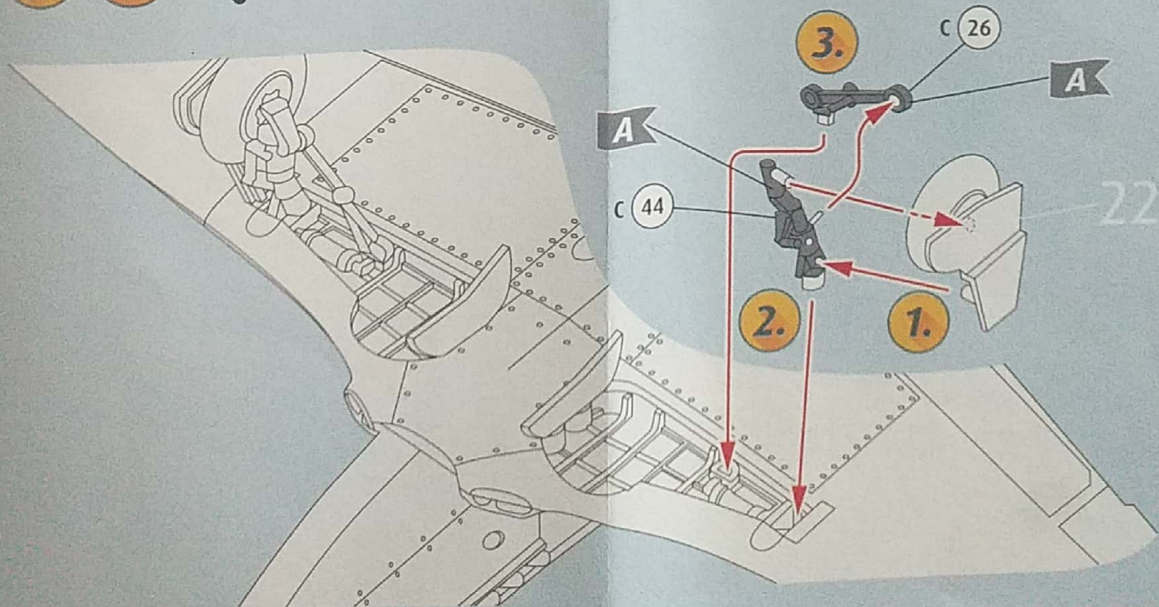
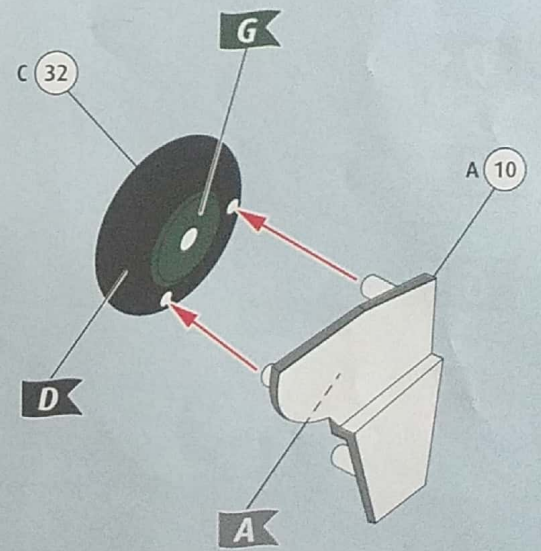
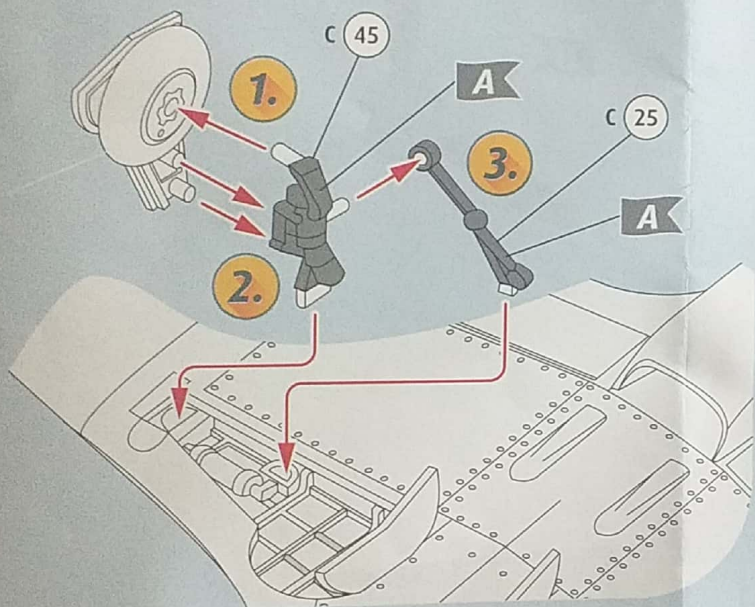
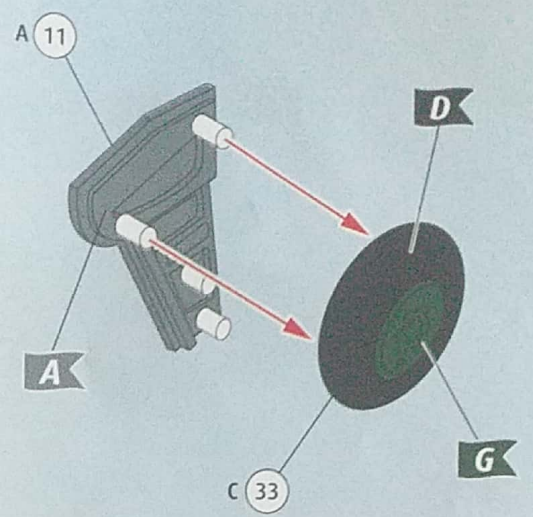
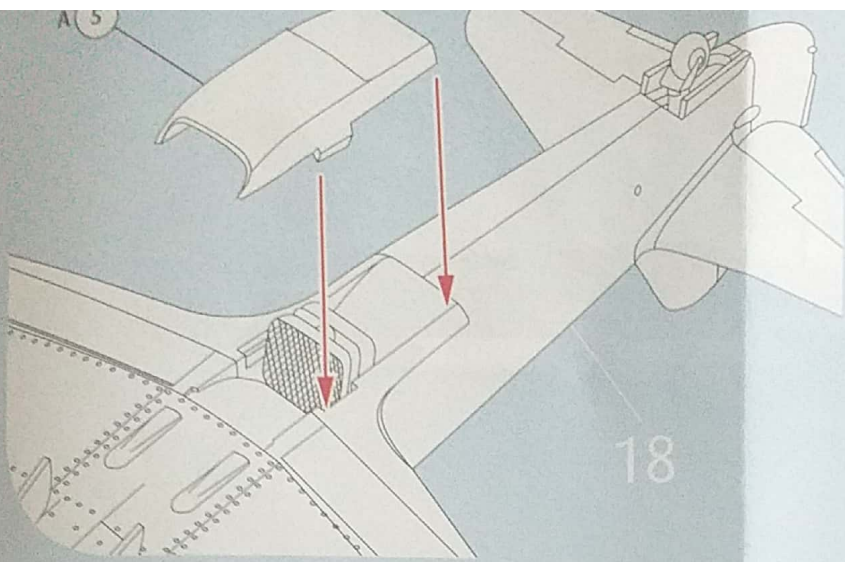



- A
- B
- C
- D
- E
- G
- J

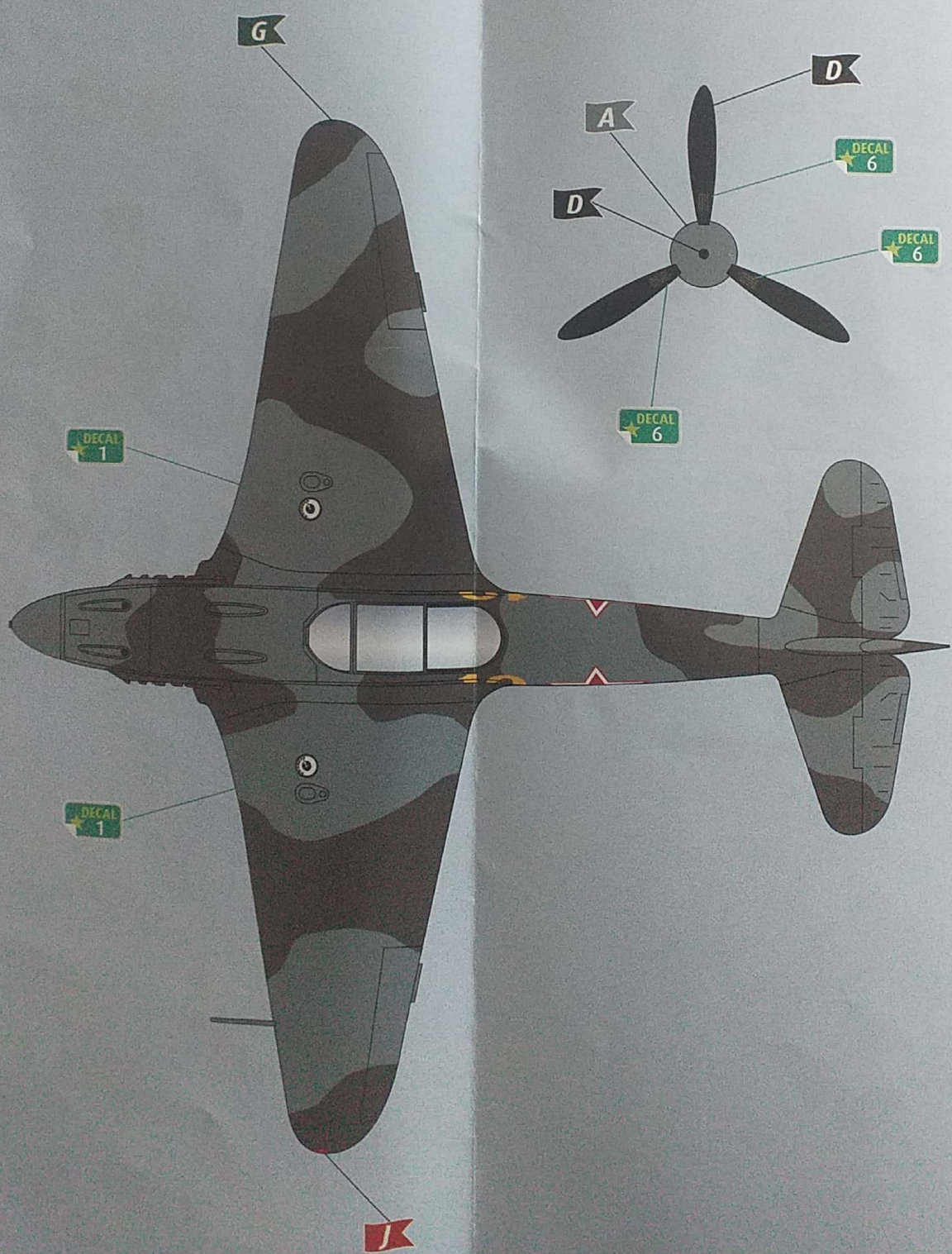





- A
- B
- C
- D
- E
- G
- J

