

1/48 P-38J/L Lightning

Download full guide from www.uprise-decal.ru

A.

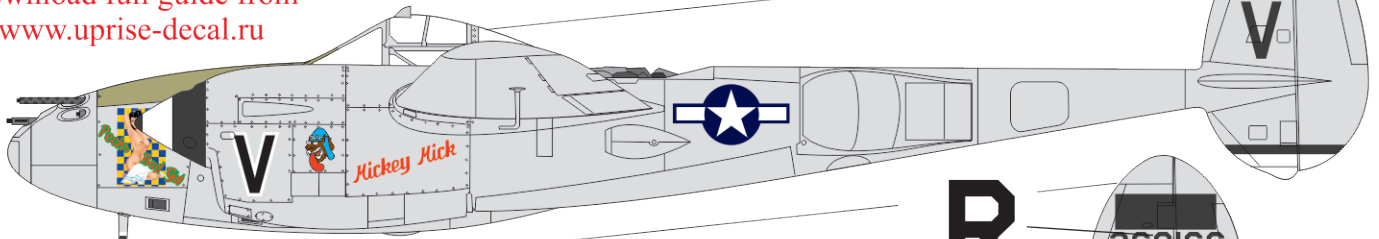

B.

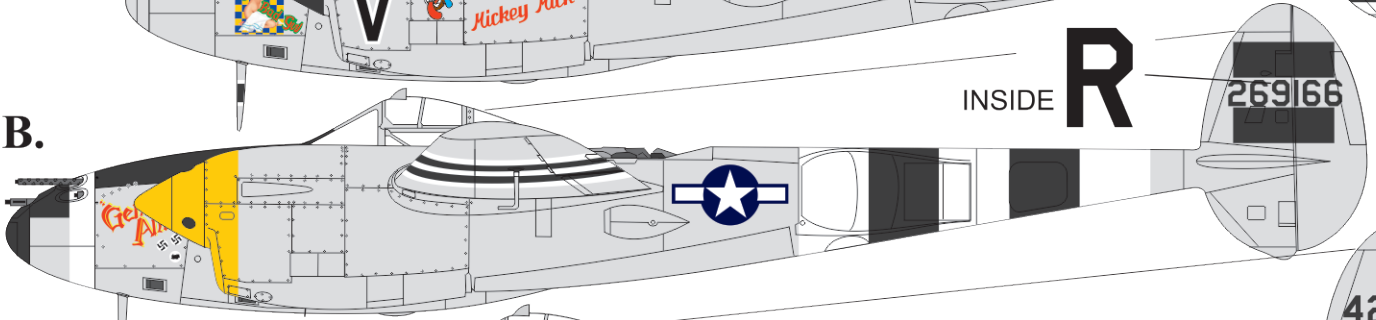

C.

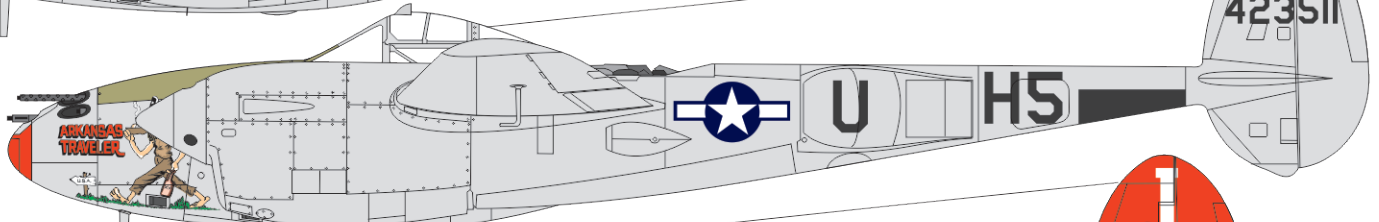

D.

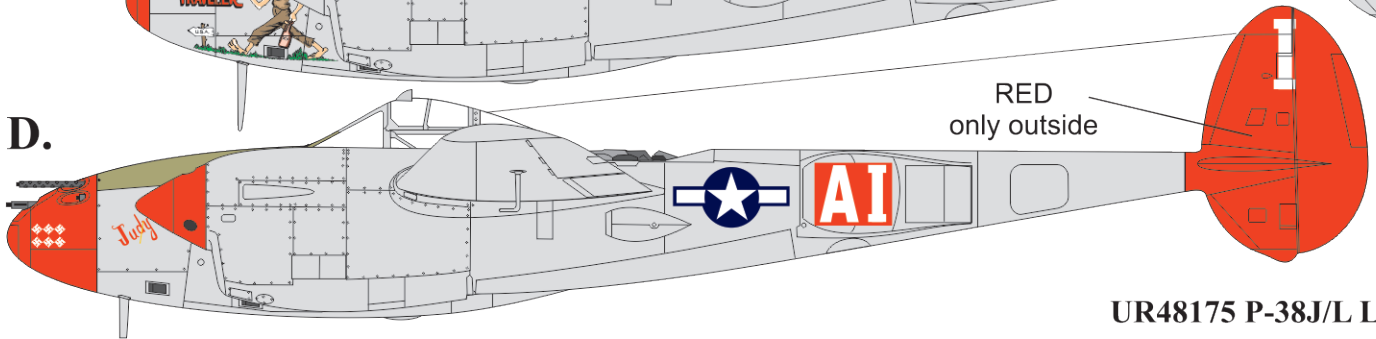

UR48175 P-38J/L Lightning

E.

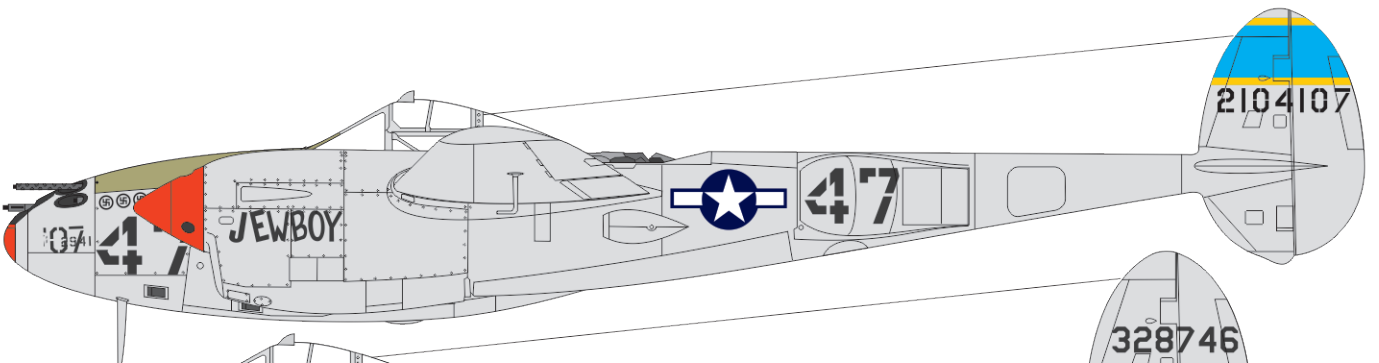

F.

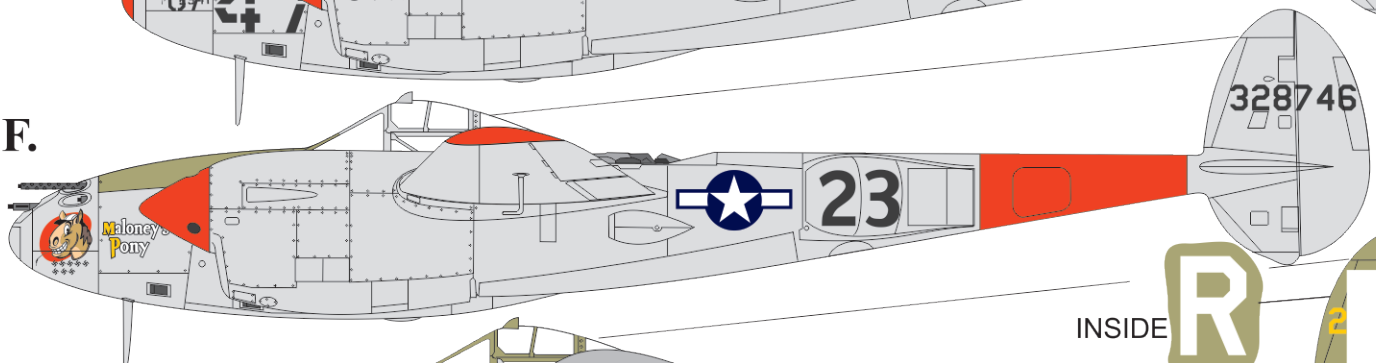

G.

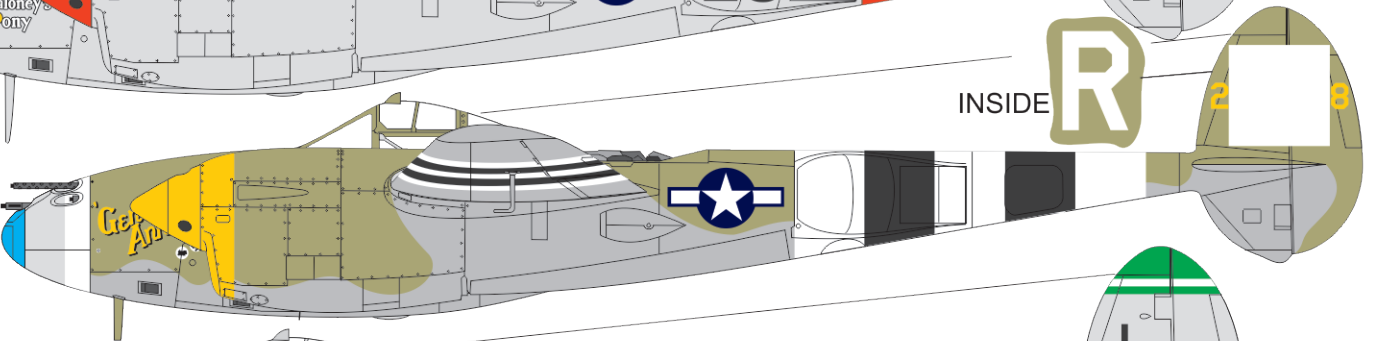

H.

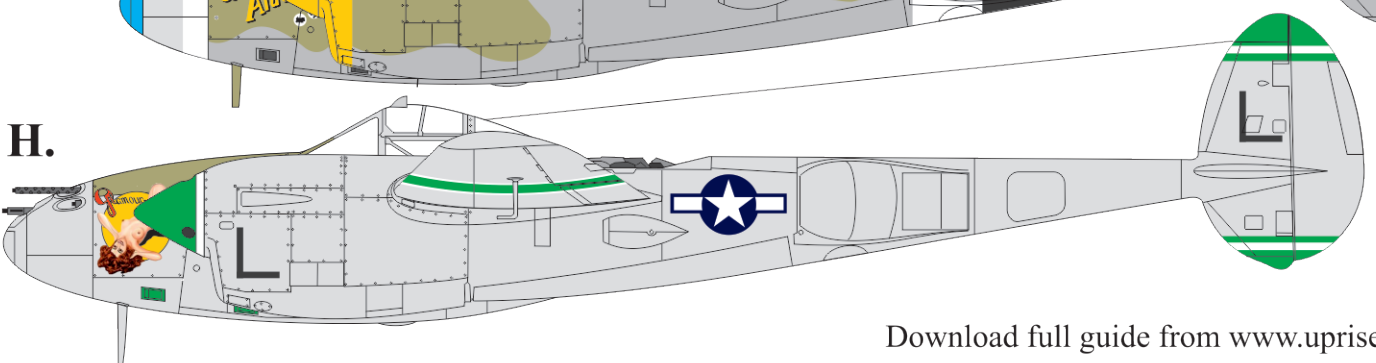

Download full guide from www.uprise-decal.ru

A. P-38L-5-LO "Peck's Bad Girl"

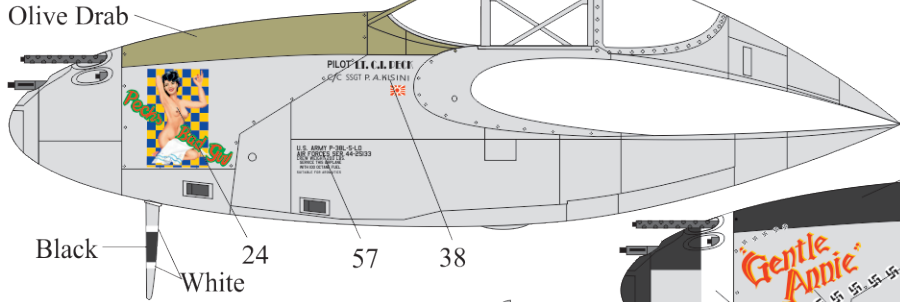

B. P-38J-15-LO "Gentle Annie"

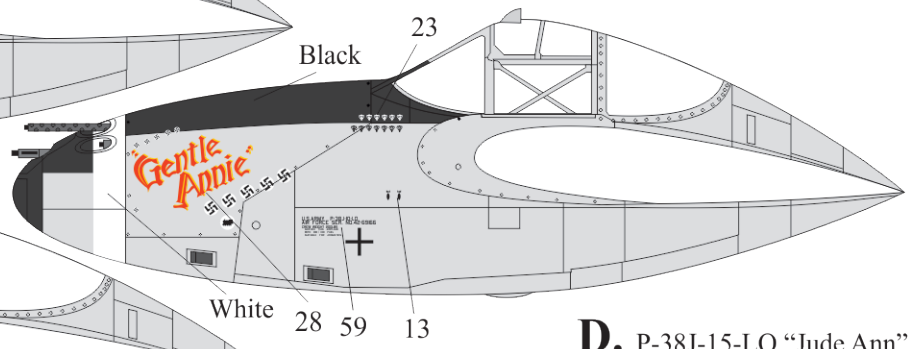

C. P-38J-20-LO "Arkansas Traveler"

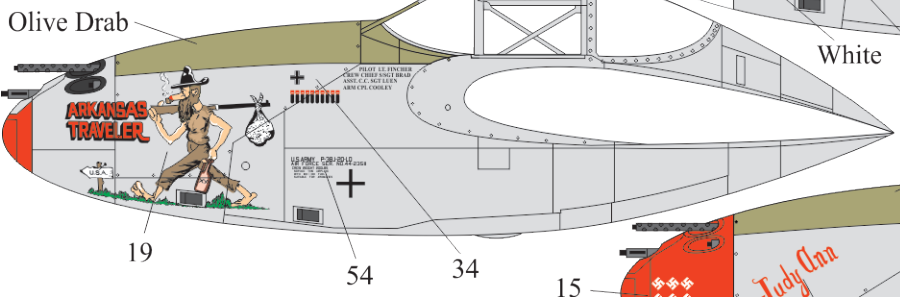

D. P-38J-15-LO "Jude Ann"

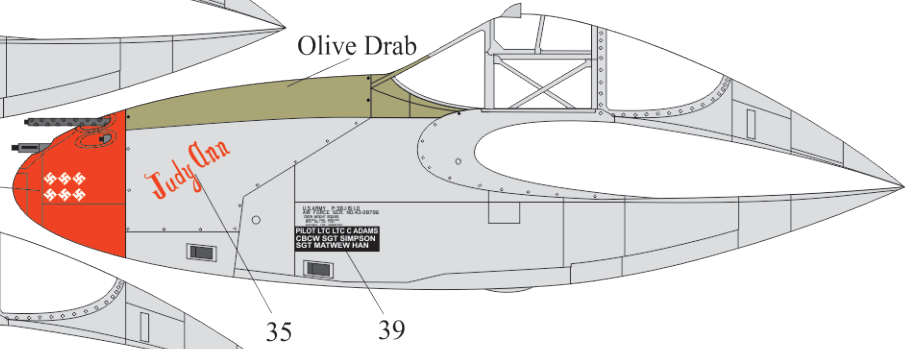

E. P-38J-15-LO "JewBoy"

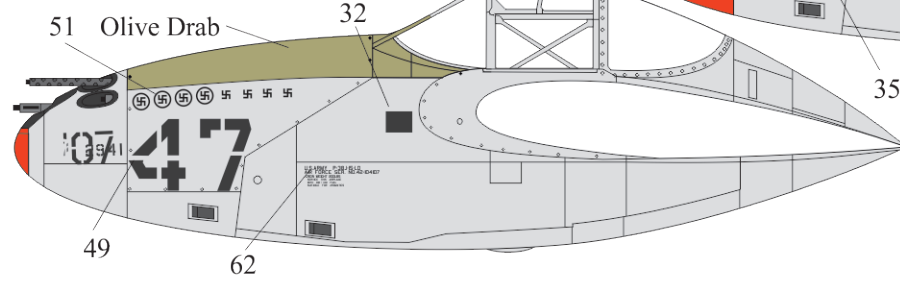

F. P-38J-15-LO Maloney's Pony

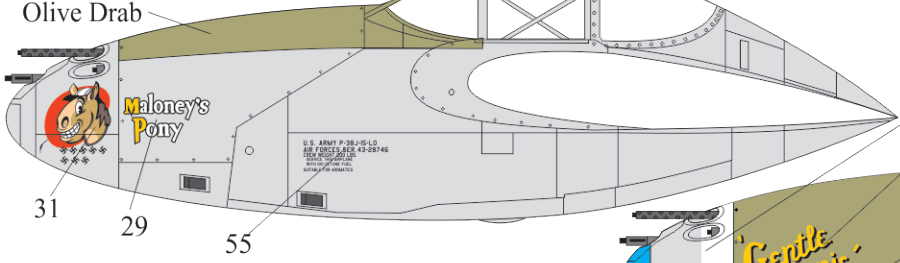

G. P-38J-15-LO "Jude Ann"

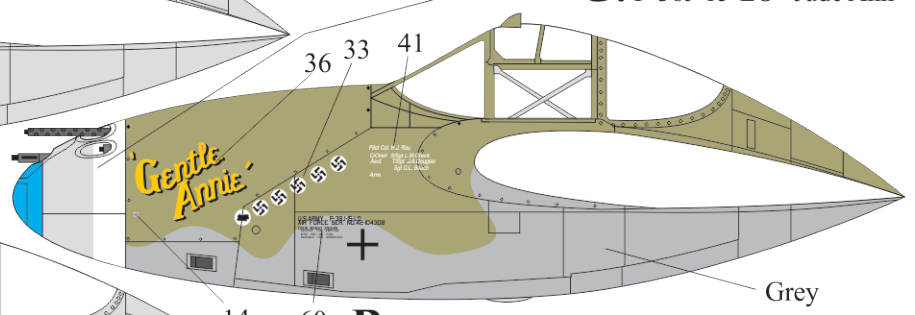

H. P-38L-5-LO "Glamour Puss II"

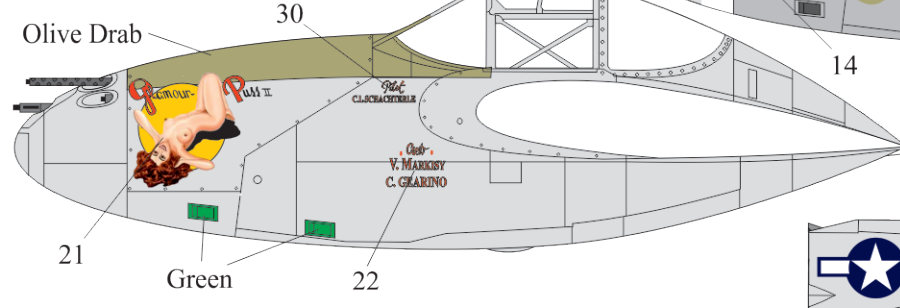

B. Second variant without invasion stripes.

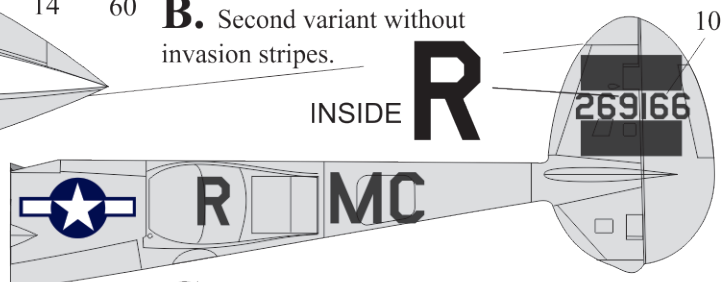

D. Second variant.

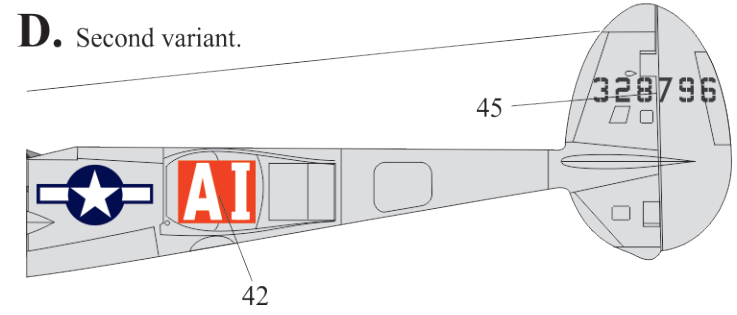

G. Second variant without invasion stripes.

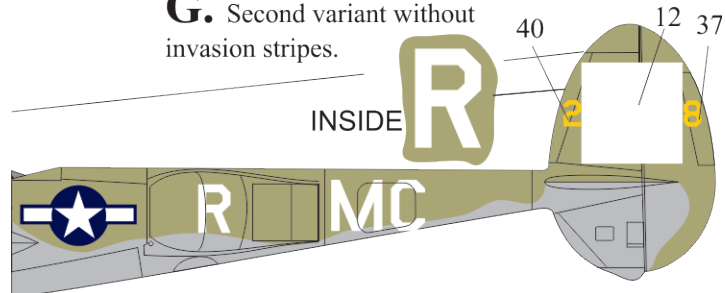

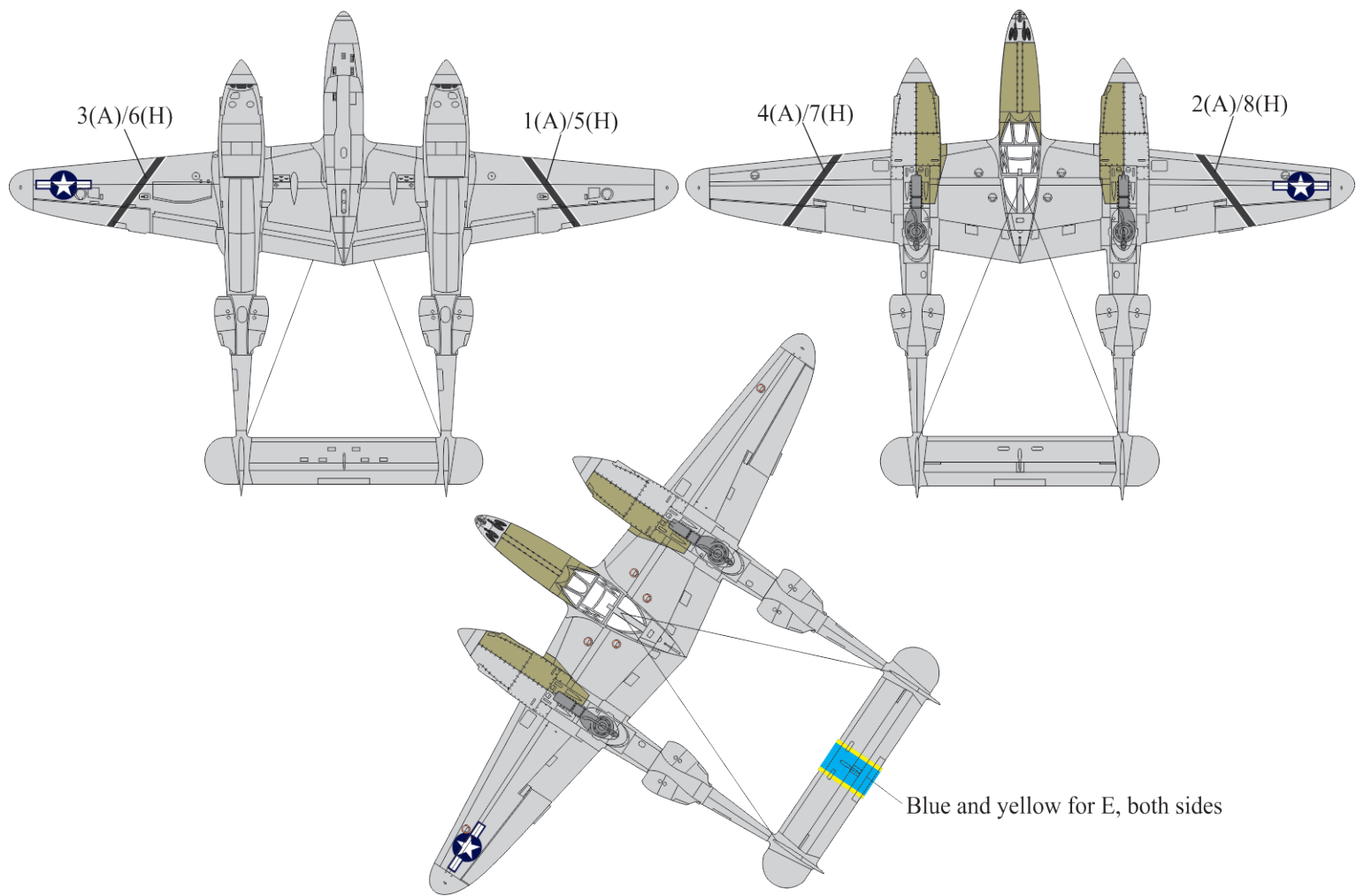

- 1:24
- 1:32
- 1:48
- 1:72

P-38 Lightning stencils

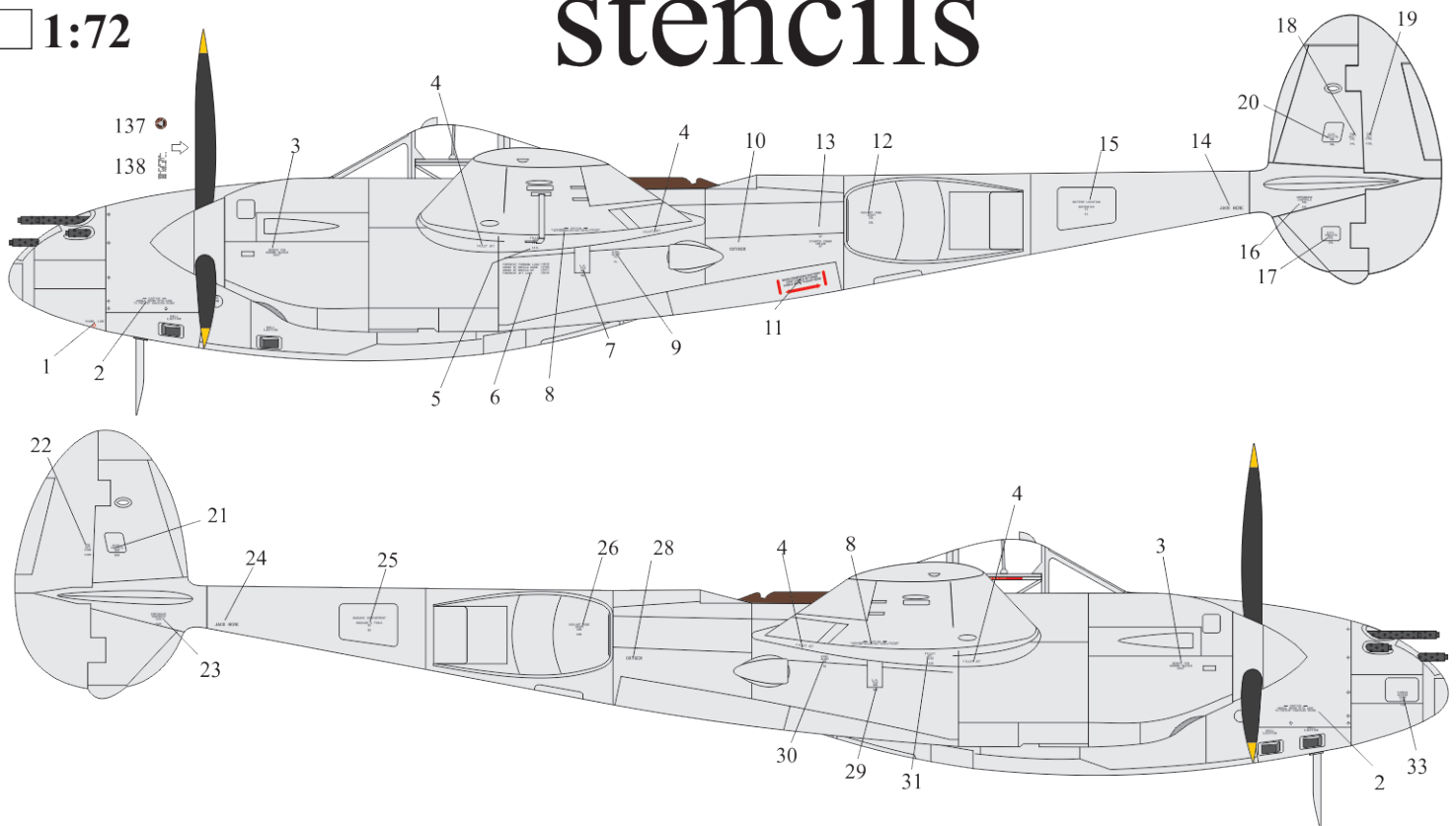

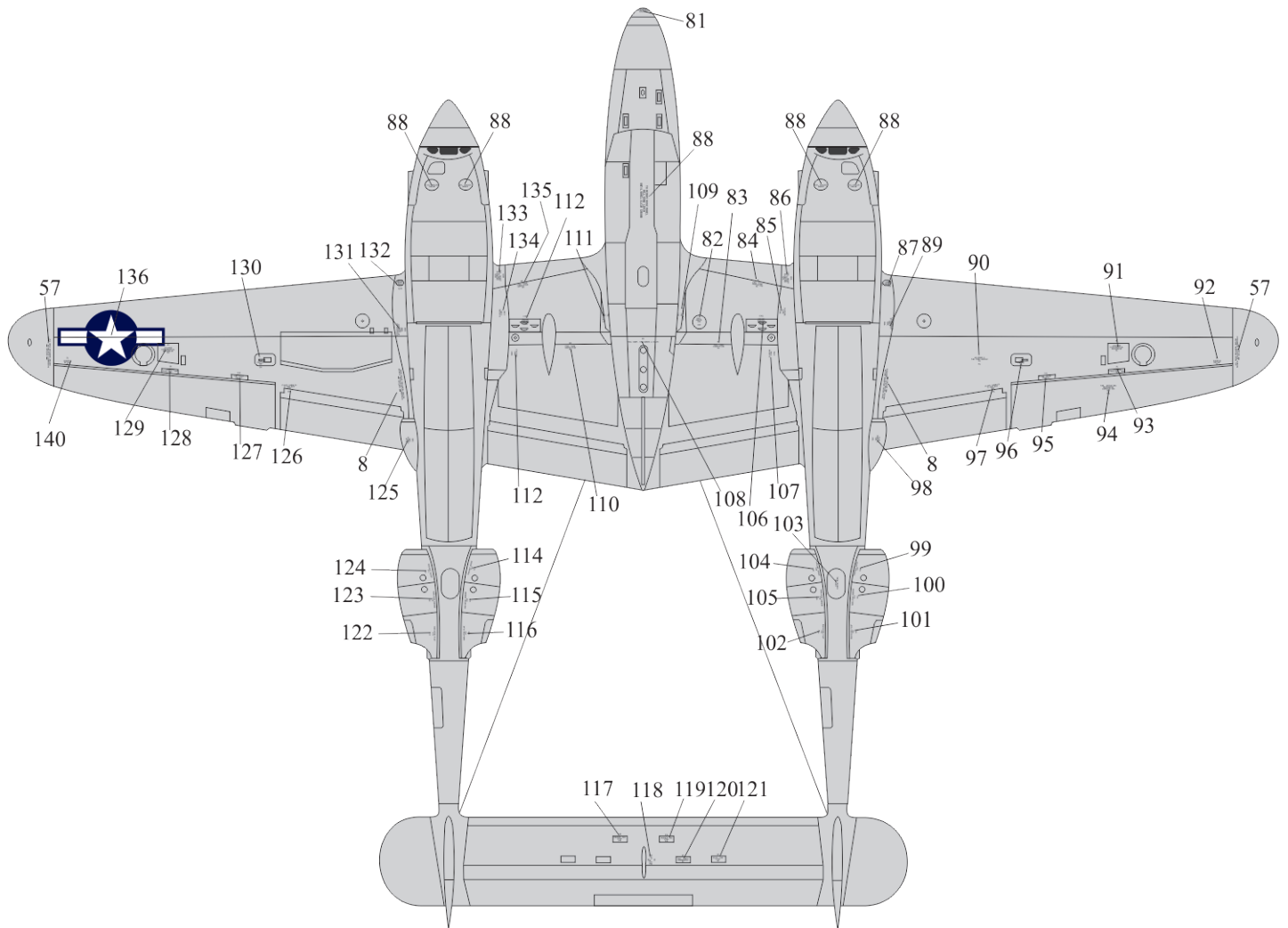
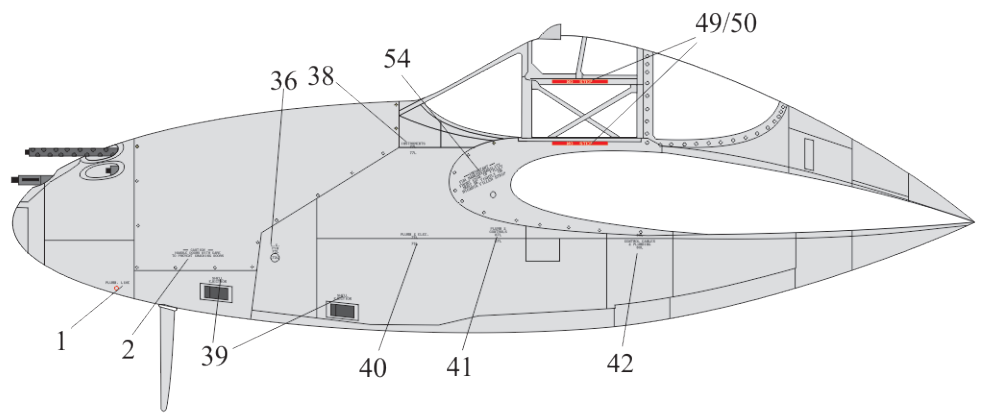
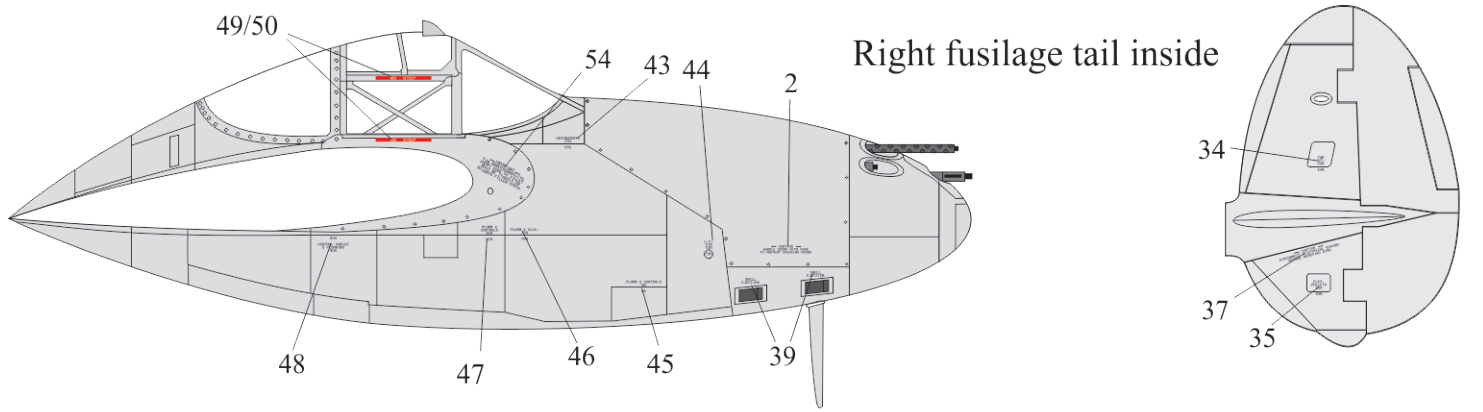

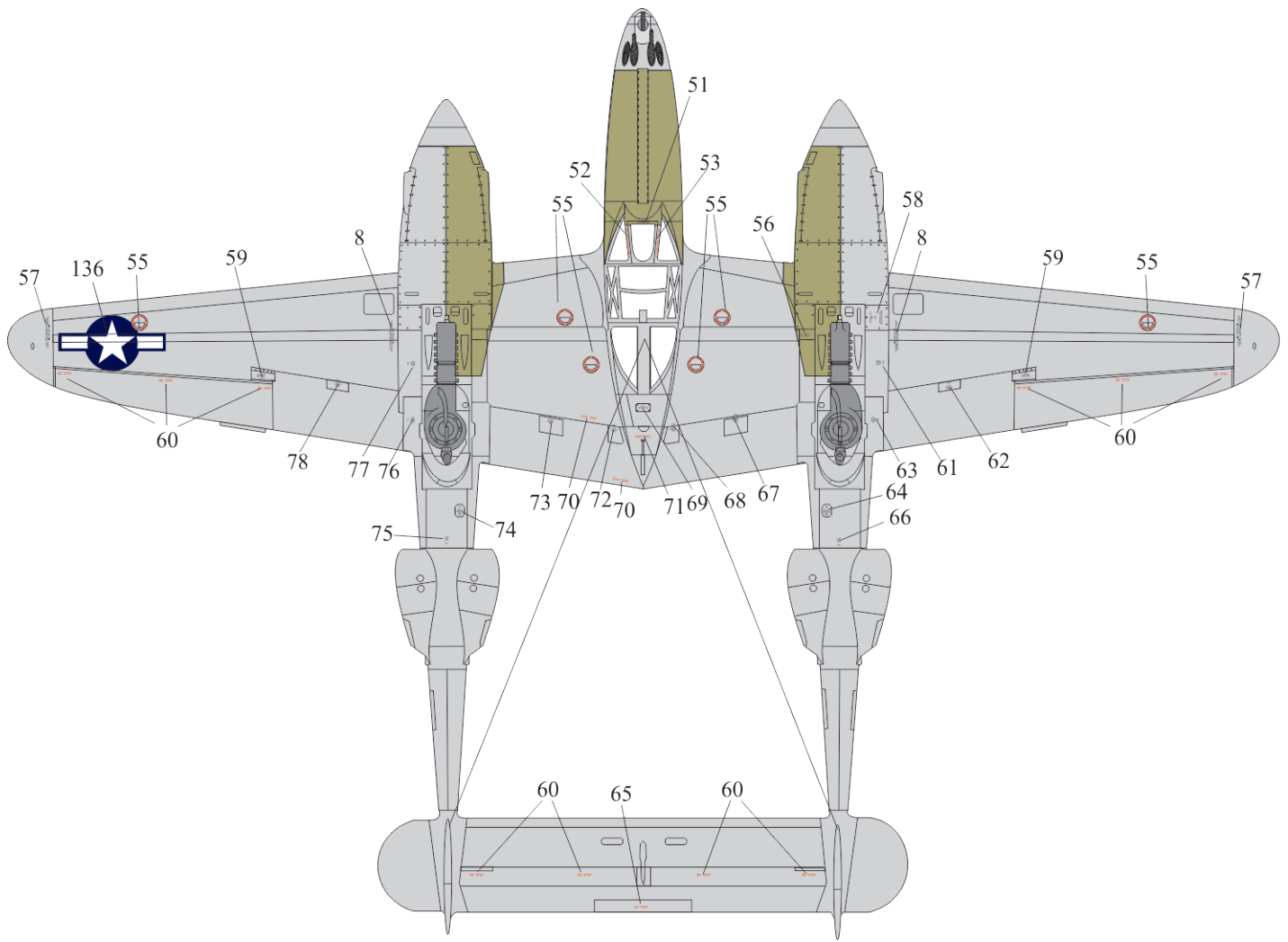

Vizit to www.uprise-decal.ru for more decal sets.
 Поемуме саїм www.uprise-decal.ru.



P-51D Mustang George Preddy

P-51D-30NT, present time. Ultra shine silver.
 Painted as George Preddy's
 P-51D-5NA at August 1944.

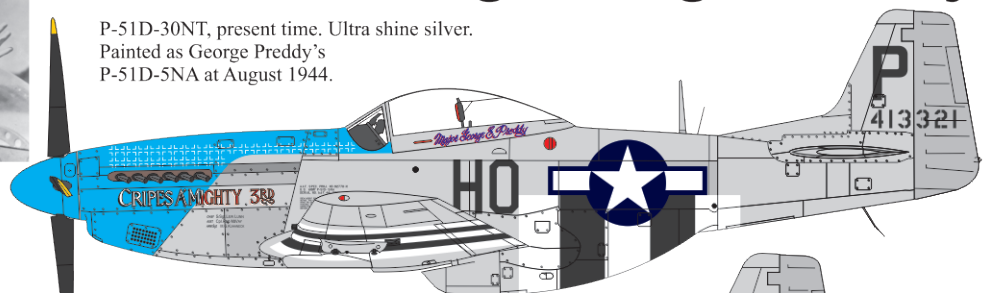

P-51D-5NA, July 1944.
 487 FS, 352 FG,
 8 AF, USAAF,
 Bodney UK
 invasion stripes
 only on bottom

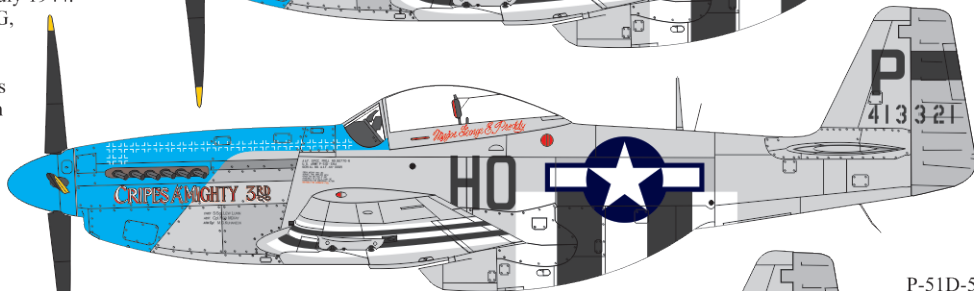

P-51D-5NA, June 1944.
 487 FS, 352 FG, 8 AF,
 USAAF, Bodney UK
 invasion stripes
 over the wing and fuselage.

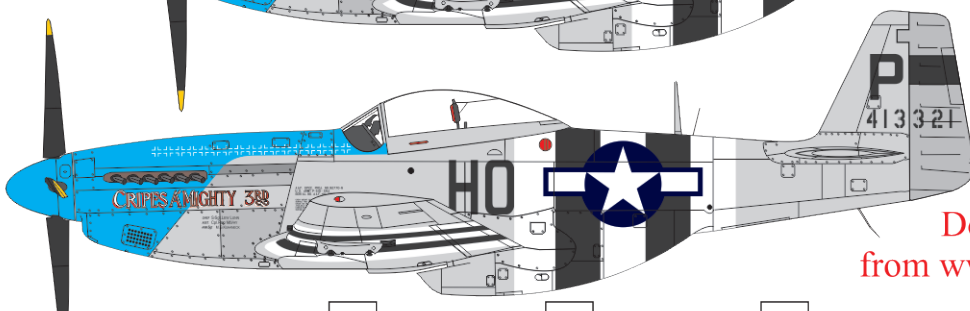

Download full guide
 from www.uprise-decal.ru

UR14436 UR7236 UR4836 UR3236 UR2436

P-51D-25 Mustang Iwo Jima, 1945

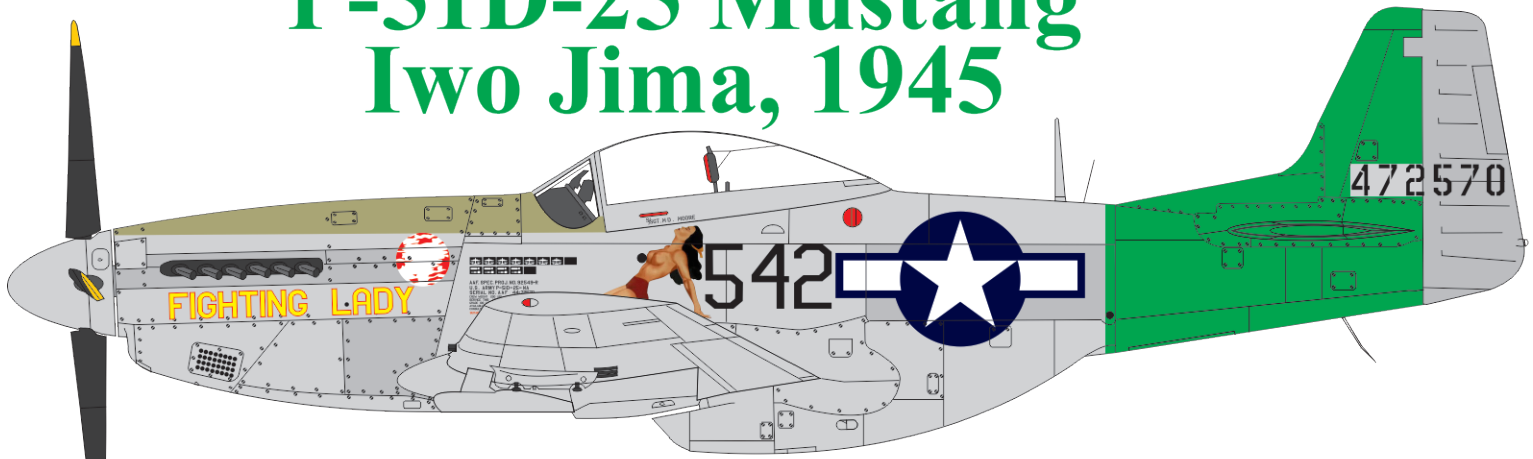

Download full guide from www.uprise-decal.ru



UR144128 UR72128 UR48128 UR32128 UR24128

P-51B/C Mustang *Blue Nose Bastards*

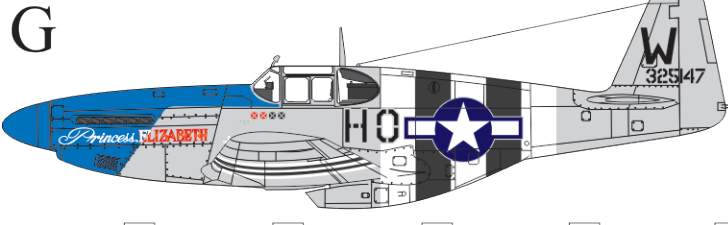
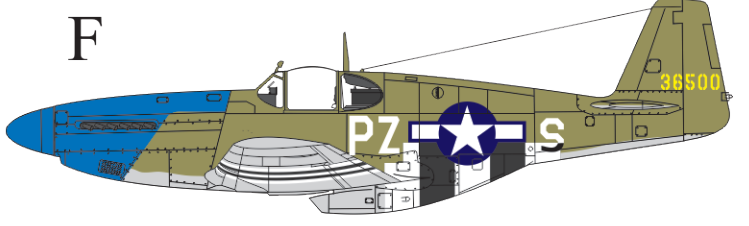
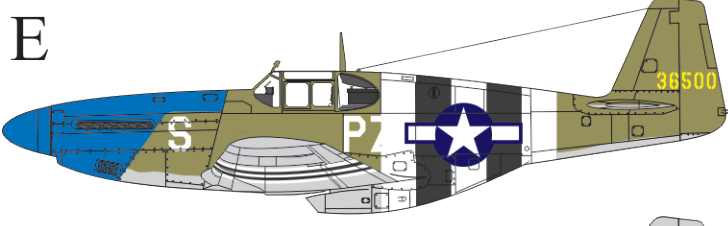
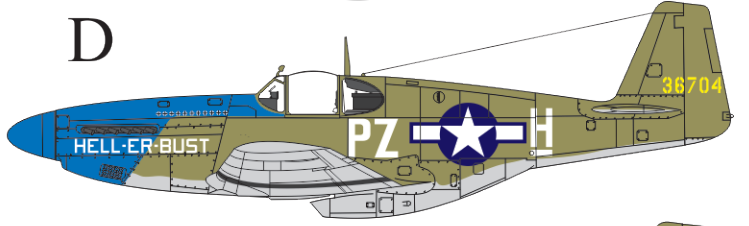
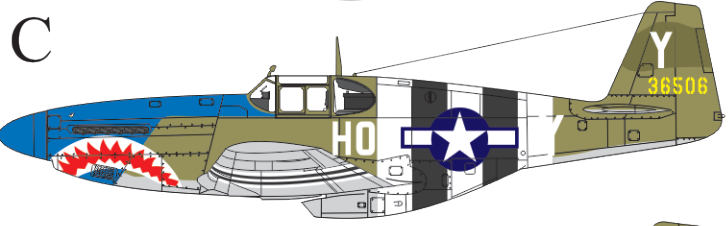
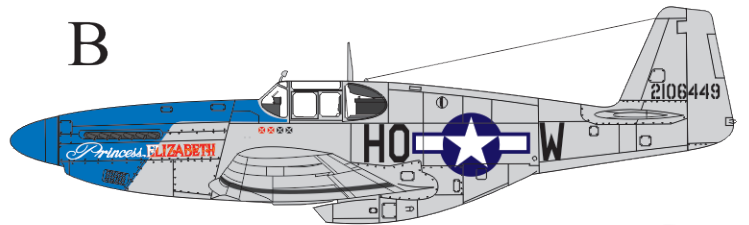
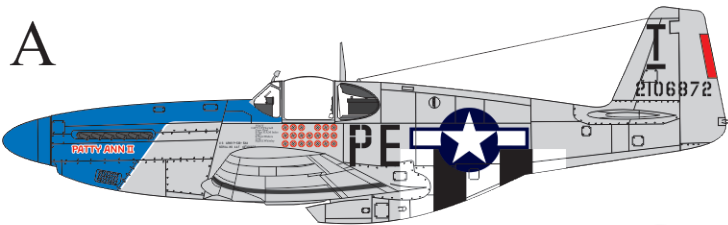

Download guide from www.uprise-decal.ru

UR144228 UR72228 UR48228 UR32228 UR24228

- A. P-51B-5 Lt. John F. Thornell, Jr. of the 352nd FG, 486th FS, 8th AF, July 1944
- B. P-51B-10 Captain William T "Whiz" Whisner of the 352nd FG, 487th FS, 8th AF, May 1944.
- C. P-51B-5 Major John R "Muscles" Bennett of the 352nd FG, 487th FS, 8th AF
- D. P-51B-5 Lt. Ed Heller of the 352nd FG, 487th FS, 8th AF, May 1944
- E. P-51B-5 Lt. Stanley "Stan" Miles of the 352nd FG, 486th FS, 8th AF, June 1944
- F. P-51B-5 Lt. Stanley "Stan" Miles of the 352nd FG, 486th FS, 8th AF, 1944.
- G. P-51C-15 May 2007, painted as P-51B of Capt. William T "Whiz" Whisner.



BF.109G-5/6/6Trop "Gustav"

A. Bf.109G-5, WNr. 27119, 9./JG54, Spring 1944, Ludwigslust (Germany), pilot Gerhard Kroll, crashed 8 April 1944

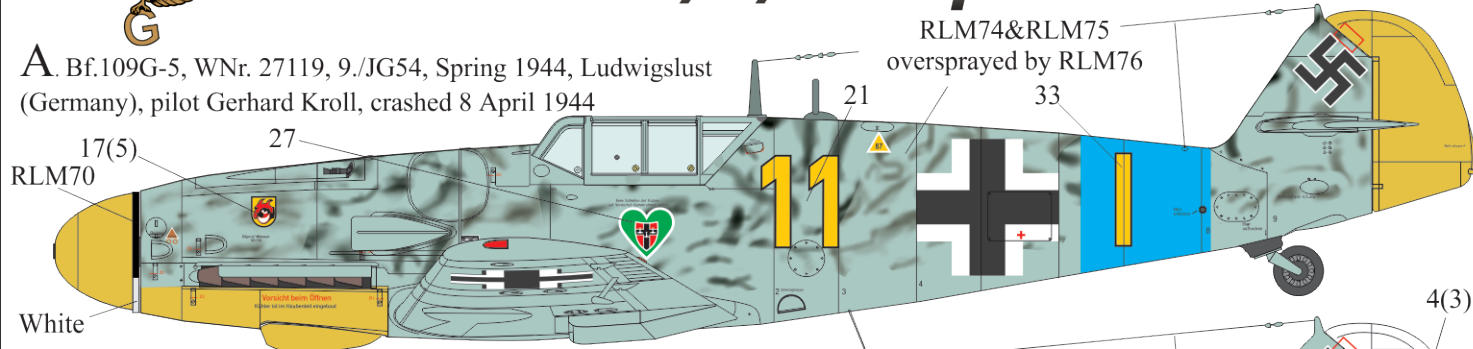

B. Bf.109G-5, WNr. 27112, 3./JG54, December 1943, Russia, pilot Walther Dahl

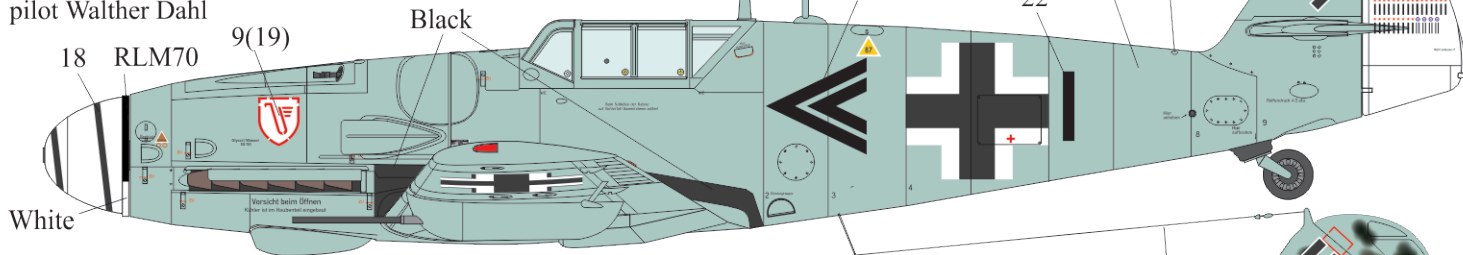

C. Bf.109G-6, 7./JG53, January 1943, Italy (Sicily), pilot unknown

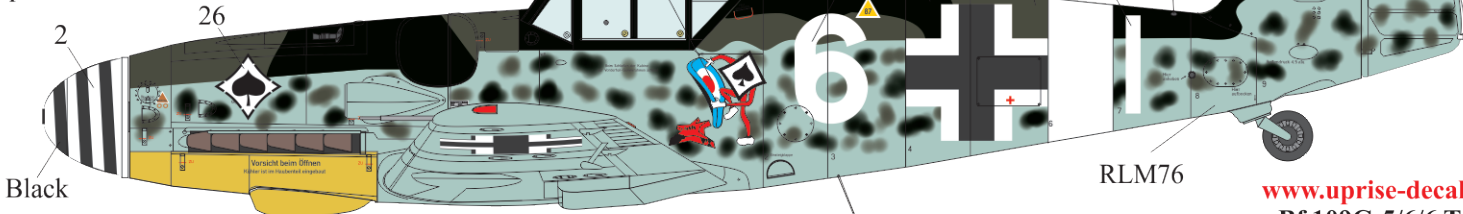

www.uprise-decal.ru
Bf.109G-5/6/6 Trop

D. Bf.109G-6, WNr.18107, 7./JG53, May 1943, Italy (Sicily), pilot Georg Amon

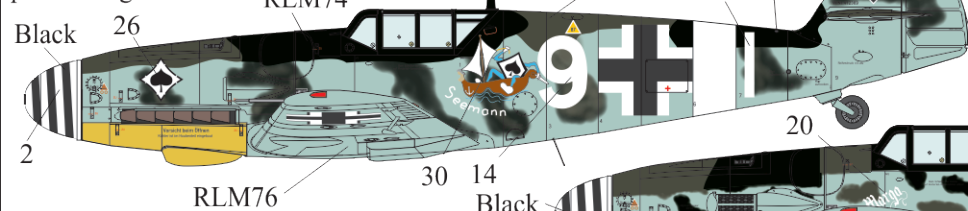

E. Bf.109G-6 Trop, WNr.27169, 11./JG27, November 1943, Greece (Kalamaki Airfield), pilot Heinrich Bartels

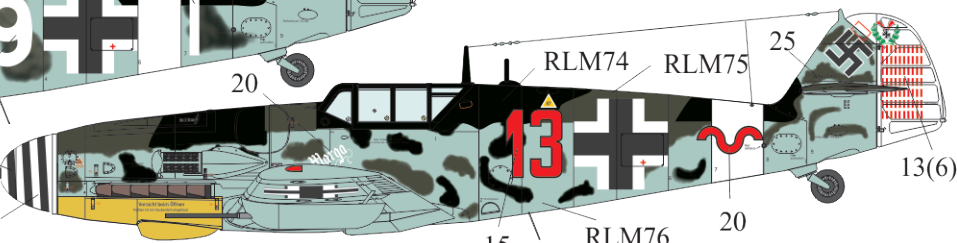

F. Bf.109G-6, WNr.26082, 7./JG11, October 1943, Germany (Oldenburg), pilot Victor Wildmayer

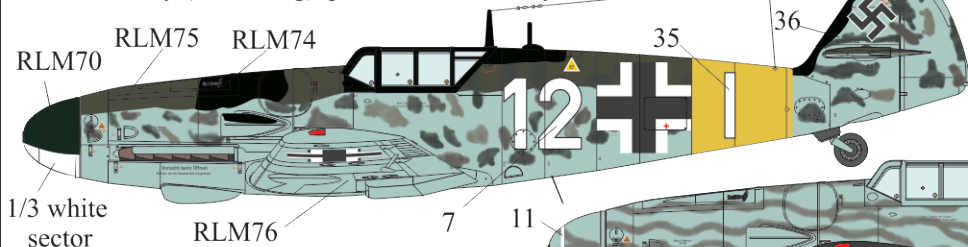

G. Bf.109G-5 (or G-6), 1./JG300, March 1944, Germany (Bonn-Handelar), pilot Hans Werner-Gross

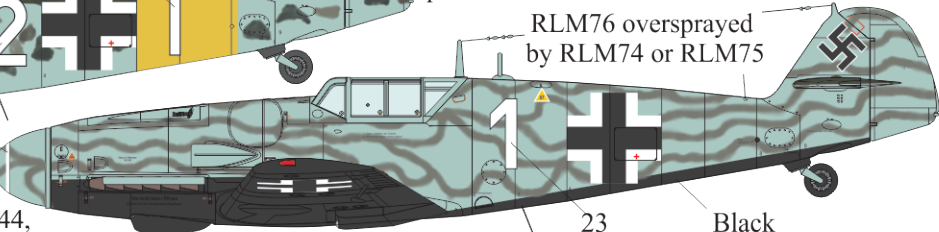

H. Bf.109G-6, WNr.27119, 9./JG54, February 1944, Germany (Ludwigslust), pilot Wilhelm Schilling

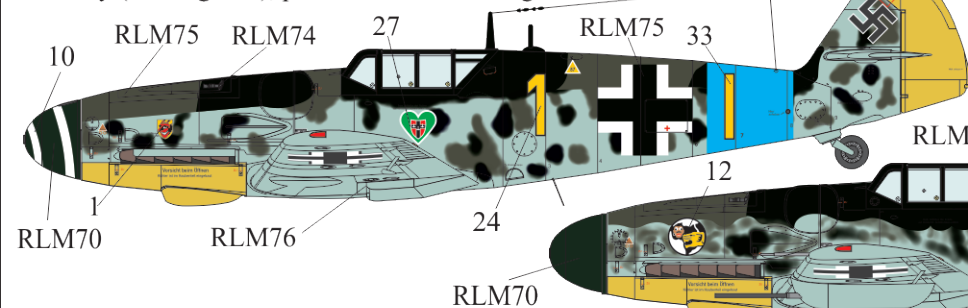

I. Bf.109G-6, 1./JG27, Early 1944, pilot Ludwig Franzisket

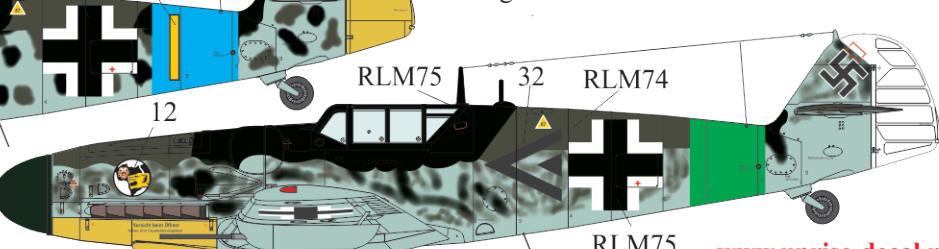

www.uprise-decal.ru