

US WWII FIGHTER 1:48 SCALE PLASTIC KIT



ProfiPACK



eduard

intro

The P-39 Airacobra was developed by the Bell Aircraft Corporation in Buffalo, New York in the late 30's. The first XP-39 prototype had its maiden flight on April the 6th, 1939 in Dayton, where it reached a maximum speed of 628km/h at 6100 m, climbing to that height in only 5 minutes. The XP-39 had a very good flight performance, and specifically, good manoeuvrability thanks its original concept of airframe, with its Allison V-1710-17 1150 HP supercharged engine located in its centre of gravity. This engine location also gave the aircraft a long, slim nose well suited for installation of a powerful weapon. The USAAF ordered a test series of 12 YP-39s on April the 27th, but before the series was finished the project was significantly changed. Because of supercharger troubles, the original engine was replaced by a less powerful Allison V-1710-37 without a supercharger, and just 1090 HP. The YP-39 had an engine-axis Oldsmobile T-9 cal. 37mm cannon, two .50 calibre (12.7 mm) machine guns and two .30 calibre (7.62mm) machine guns mounted in the nose. The pilot seat got some armour, but the weight was increased to 3160 kg against 2820kg of the prototype. Because of these changes the maximum speed was decreased to 590 km/h and climb to 6100m now took 7.5 minutes. Although the excellent prototype flight performances were decreased, the Air force didn't loose interest and ordered 80 production P-39Cs. The first 20 of these were supplied as standard P-39Cs and the remaining 60 were finished as P-39Ds, with the two .30 calibre (7.62mm) machine guns moved to the wings and two more .30 calibre (7.62mm) machine guns were added to the same location. The USAAF received its first P-39Ds in February 1941, and the next order for 344 P-39D's was placed at this time.

The British RAF ordered 675 P-39's in April 1940. British Airacobra Mk.I's were produced in P-39D standard, but with the engine-axis cannon replaced with a British Hispano M1 20mm cannon and the wing machine guns were replaced with 7.7mm Browning's. The first Airacobra Mk.I's were received in July 1941, but the RAF was disappointed, when it was found that they were not suitable for service in the European war theatre. In October 1941 four Mk.I's were tested by 601 Squadron in the ground attack role over occupied France, Airacobras were withdrawn from service and 212 RAF Airacobra Mk.I's were sent to Soviet Union.

When the USA came into the war, the USAAF confiscated 179 Airacobras from the British order on the production line. They were re-designated P-400, and served in the Pacific. All P-400's have 12 exhaust pipes on each side of the engine, and this was the major difference from the P-39D series. The next block of aircraft, also with 12 exhaust pipes, were 229 aircraft of the P-39F series, and after them came the P-39K series (210 aircraft), P-39L (250 aircraft), P-39M (240 aircraft) and P-39N (2095 aircraft). All these four series were very similar, using various engines, propellers and other equipment. The final version was the P-39Q with an Allison V-1710-85 engine (1420 HP), and the main difference was the installation of two .50 calibre (12.7 mm) machine guns in under-wing pods instead of the four .30 calibre (7.62mm) wing mounted machine guns in the older series. Most of the 4905 Q series aircraft were sent to Soviet Union. Production was ceased in August 1944, after the final Airacobra, number 9558, was finished.

The USAAF employed Airacobras extensively until August 1944, when they were withdrawn from front line service. The USAAF used the largest number of Airacobras, 2105 of all types, in February 1944. They served in the Pacific theatre, as well as in North Africa and Italy.

In total 4758 Airacobras were sent to Russia (actually 4924, but 166 aircraft were lost during transport) where they were very popular for their solid metal airframe and heavy weapons. The French Air Force had 165 Airacobras, and P-39's also served with the Australian RAAF, the Italian AF and the Portuguese AF. After the war a number of Airacobras were employed in civilian service and used for air races.

úvodem

P-39 Airacobra byl vyvinut společností Bell Aircraft Corp. z Buffala ve druhé polovině třicátých let. Prototyp XP-39 absolvoval svůj první let 6.4.1939 v Daytonu, kde dosáhl maximální rychlosti 628 km/h ve výšce 61000m. Na tuto výšku vystoupal za pouhých 5 minut. XP-39 měl velmi dobré letové vlastnosti, mimo jiné i díky své originální konstrukci, kdy turbokompresorem vybavený motor Allison V-1710-17 o výkonu 1150 k byl umístěn v těžišti letounu, v trupu za kabinou. Toto umístění motoru také uvolnilo příď pro instalaci silné výzbroje. 27.dubna USAF objednalo zkušební sérii 12 YP-39, ale před jejím dokončením byl projekt významně upraven. Pro potíže s turbokompresorem byl původní motor nahrazen motorem Allison V-1710-37 bez turbokompresoru, dávajícím jen 1090 k. Mezi bloky válců byl namontován kanon Oldsmobile T-9 ráže 37mm, střelícíci dutým hřídelem vrtele, do příďe byly instalovány dva kulomety ráže 12,7 mm a dva ráže 7,7 mm. Pilotovo sedadlo dostalo pancérování, ale hmotnost vzrostla na 3160kg oproti 2820kg prototypu. Rychlost poklesla na 590 km/h a výstup na 6100m nyní trval 7,5 minut. Přestože výkony stroje poklesly, USAAF neztratilo zájem a objednalo 80 produkčních P-39C. Z nich bylo 20 dodáno skutečně jako P-39C, zbylých 60 pak bylo upraveno na standard verze D, se dvěma kulomety ráže 12,7 mm v přídi a čtyřmi kulomety ráže 7,62 instalovanými v křídle. USAAF dostalo své první P-39D v únoru 1941 a objednalo dalších 344 kusů. Britové objednali v dubnu 1940 675 Airacober. Byly dodány v červnu 1941. Odpovídají verzi D upravené podle britských požadavků. Kanon Oldsmobile byl nahrazen kanonem Hispano M1 ráže 20 mm, a křídelní kulometry byly britské Browning ráže 7,7 mm. RAF testovaly čtyři Airacober Mk.I v bojových podmínkách u 601. squadrony v říjnu 1941 (kde si je vyzkoušeli i někteří čs.piloti), ale byli zklamáni jejich výkony. Zbylých 212 Airacober Mk.I pak bylo posláno do Ruska a předáno sovětskému letectvu.

Po vstupu USA do války, 179 britských Airacober bylo konfiskováno na výrobní lince. Stroje byly označeny P-400 a bojovaly většinou v Pacifiku. Všechny P-400 měly 12 výfukových nátrubků na každé straně motoru, což je jejich hlavní rozlišovací znak od P-39D. V dodávkách následoval blok 229 letadel verze P-39F, také s 12 výfukovými nátrubky, po něm pak verze P-39K (210 letadel), P-39L (250 letadel), P-39M (240 letadel) a velký blok 2095 letadel verze P-39N. Všechny čtyři tyto série si byly velmi podobné, používaly různé motory, vrtele a další vybavení. Poslední a nejrozšířenější verzí byla verze P-39Q, vybavená motorem Allison V-1710-85 o výkonu 1420 k. Její největším vnějším rozdílem oproti předchozím verzím bylo nahrazení čtyř křídelních kulometů dvěma kulomety ráže 12,7 mm, instalovanými v gondolkách pod křídly. Většina z 4905 P-39Q byla dodána do Sovětského svazu. Produkce byla ukončena v srpnu 1944 po dokončení poslední, 9558. Airacobery. USAAF používalo Airacobery v první linii do srpna 1944, kdy byly staženy z frontové služby. Nejvíce Airacober, celkem 2105 letadel všech verzí, mělo USAAF ve službě v únoru 1944. Soužily v Pacifiku, v severní Africe, Itálii i na domácích základnách.

Celkem 4758 (4924, ale 166 bylo ztraceno během přepravy) Airacober bylo dodáno Sovětskému svazu. V sovětském letectvu byly Airacobery velmi populární pro jejich robustní konstrukci a silnou výzbroj. Francouzské letectvo mělo 165 Airacober různých verzí, a P-39 byly v menších počtech používány i letectvy Austrálie, Itálie a Portugalska. Jeden kus se po válce vyskytoval i v polském letectvu. Po válce byla řada Airacober používána v civilních službách, mimo jiné jako závodní stroje. Jednu z nich vlastnil např. Miro Slovák.

ATTENTION



UPOZORNĚNÍ



ACHTUNG



ATTENTION



注意



Carefully read instruction sheet before assembling. When you use glue or paint, do not use near open flame and use in well ventilated room. Keep out of reach of small children. Children must not be allowed to suck any part, or pull vinyl bag over the head.



Před započatím stavby si pečlivě prostudujte stavební návod. Při používání barev a lepidel pracujte v dobře větrané místnosti. Lepidla ani barvy nepoužívejte v blízkosti otevřeného ohně. Model není určen malým dětem, mohlo by dojít k požití drobných dílů.

INSTRUCTION SIGNS

* INSTR. SYMBOLS

* INSTRUKTION SINNBILDEN

* SYMBOLES

* 記号の説明

OPTIONAL
VOLBABEND
OHNOUTOPEN HOLE
VYVRTAT OTVORSYMMETRICAL ASSEMBLY
SYMETRICKÁ MONTÁŽNOTCH
ZÁŘEZREMOVE
ODRÍZNOUTAPPLY EDUARDS MASK
AND PAINT
POUŽIT EDUARD MASK
NABARVIT

PARTS



DÍLY



TEILE



PIĚCES



部品

PLASTIC PARTS

A>

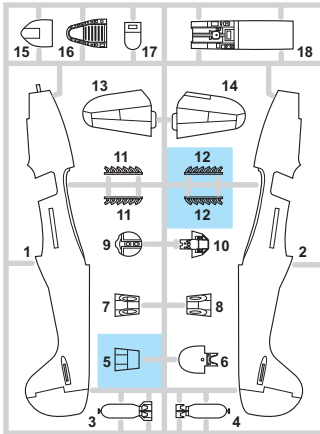

B>

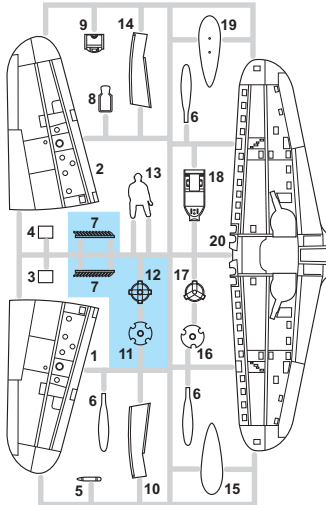

C>

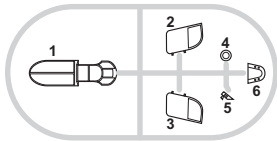
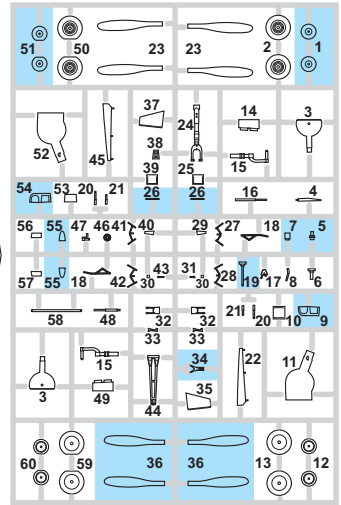
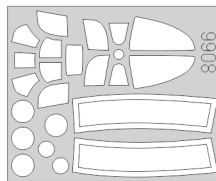
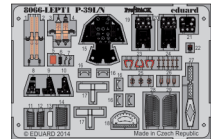
eduard
MASKPE - PHOTO ETCHED
DETAIL PARTS

Parts not for use. -Teile werden nicht verwendet. -Pièces à ne pas utiliser. -Tyto díly nepoužívají při stavbě. -使用しない部品

COLOURS



BARVY



FARBEN



PEINTURE



色

| GSI Creos (GUNZE) | | |
|-------------------|-----------|----------------|
| AQUEOUS | Mr. COLOR | |
| [H 14] | [4] | YELLOW |
| [H 32] | [33] | FLAT BLACK |
| [H 13] | [3] | RED |
| [H 33] | [81] | RUSSET |
| [H 29] | [12] | OLIVE DRAB |
| [H 53] | [13] | NEUTRAL GRAY |
| [H 58] | [27] | INTERIOR GREEN |
| [H 71] | [21] | MIDDLE STONE |

| AQUEOUS | Mr. COLOR | |
|--------------------------|-----------|-------------------|
| [H 72] | [369] | DARK EARTH |
| [H 73] | [137] | TIRE BLACK |
| [H 18] | [C316] | WHITE |
| [H 19] | [370] | AZURE BLUE |
| Mr. COLOR SUPER METALLIC | | |
| [SM 01] | | SUPER FINE SILVER |
| Mr. METAL COLOR | | |
| [MC 210] | | DARK IRON |
| [MC 218] | | ALUMINIUM |

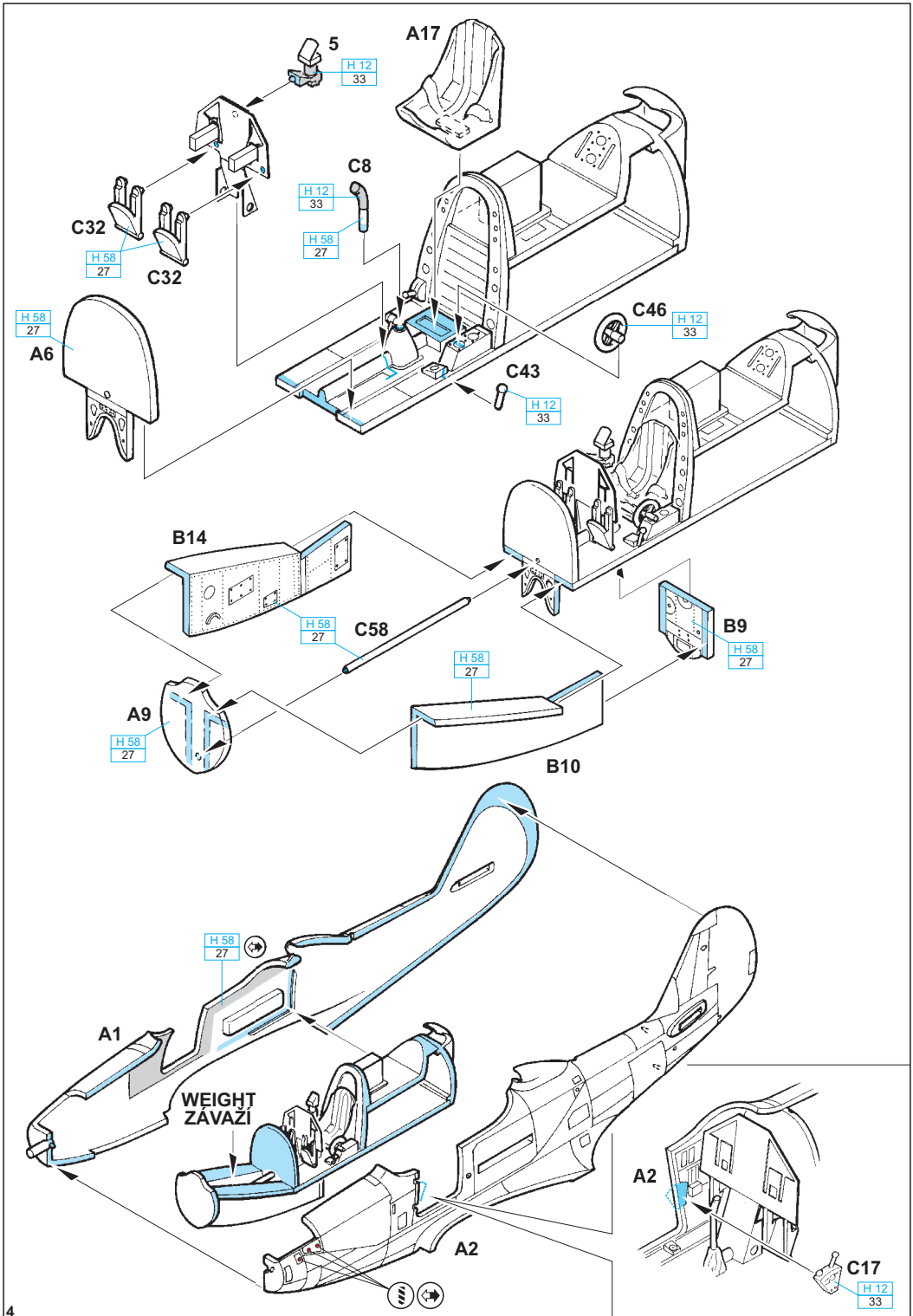

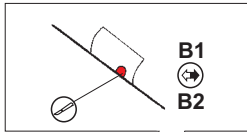

A8 - MARKINGS **A, B, C**
 A7 - MARKINGS **D, E**

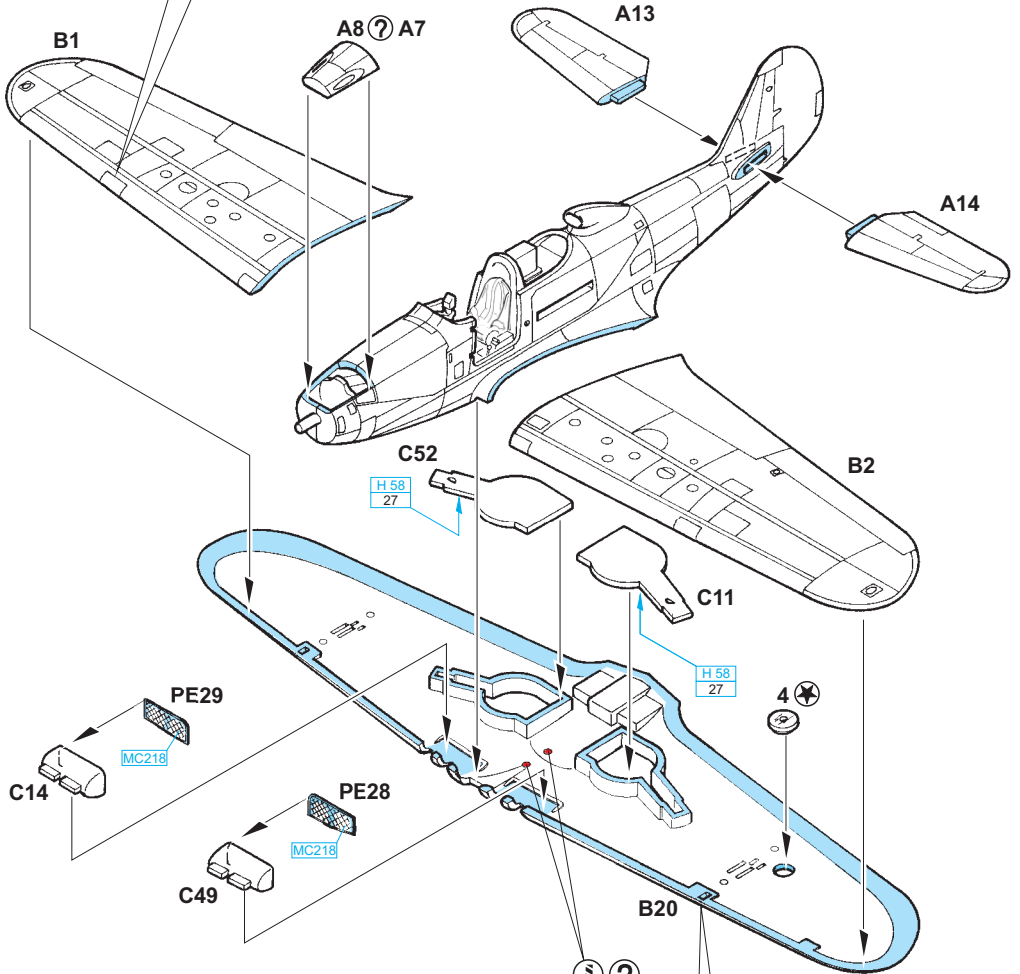

OPEN HOLES IF YOU WANT ADJUST
 THE BOMB OR FUEL TANK RACK (SEE PAGE 7)
 VRTAT V PŘÍPADĚ POUŽITÍ BOMBY
 NEBO PŘÍDAVNÉ NÁDRŽE (VIZ STRANA 7)

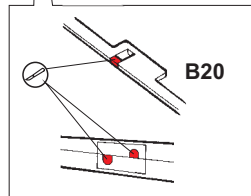

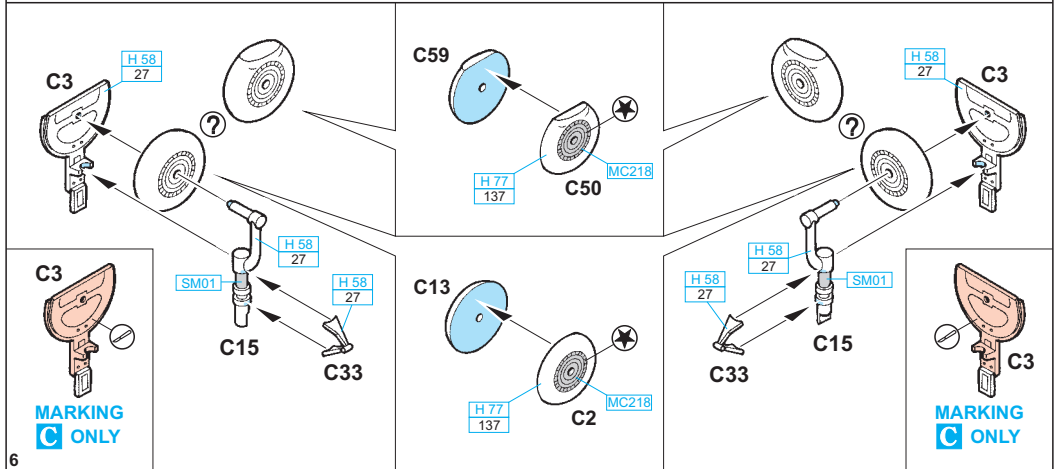
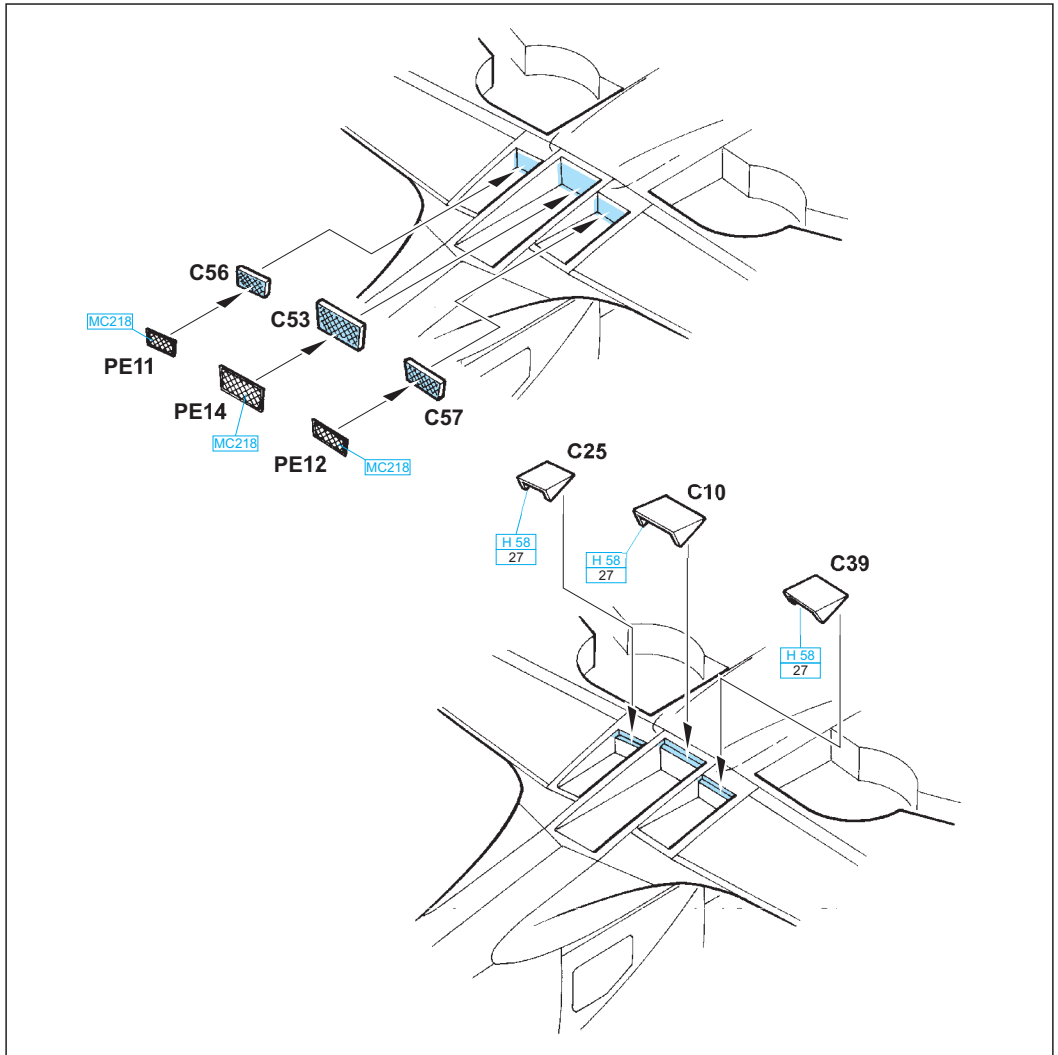

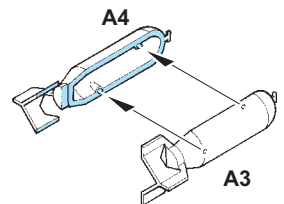
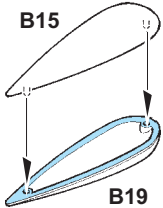
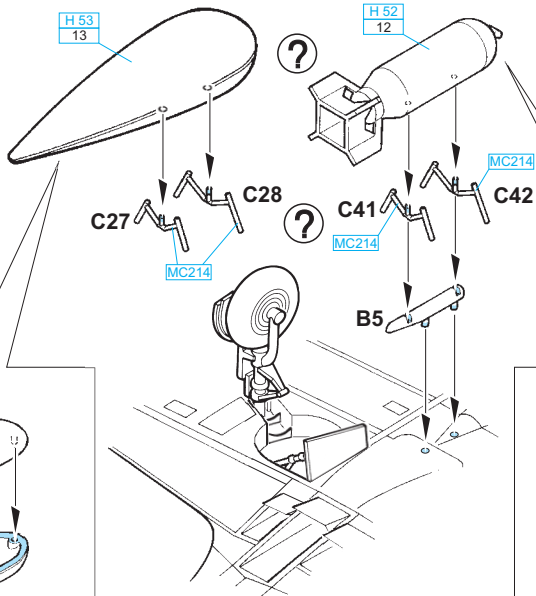
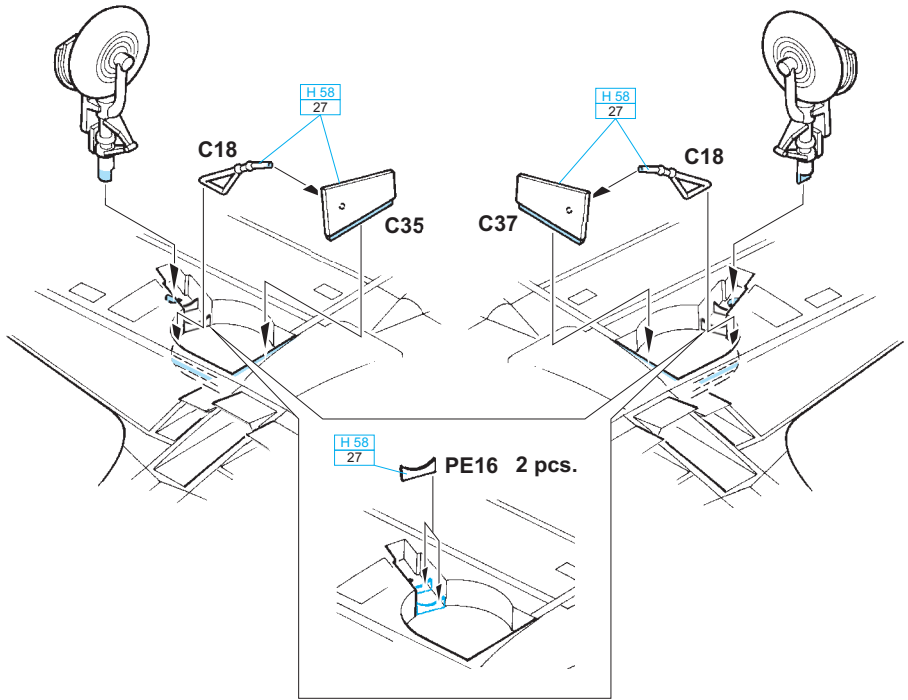

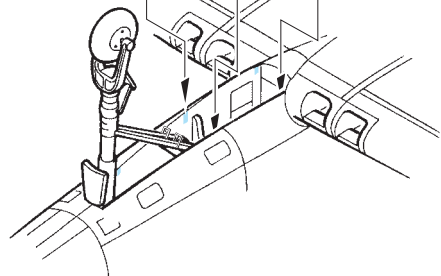
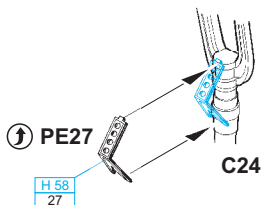
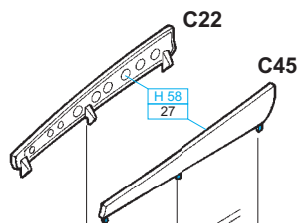
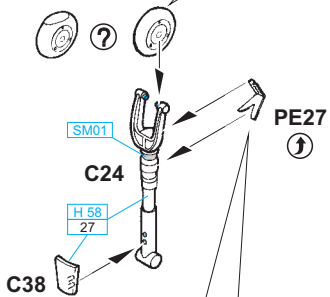
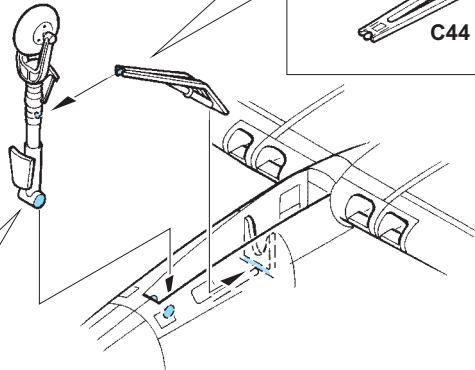
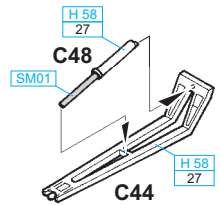
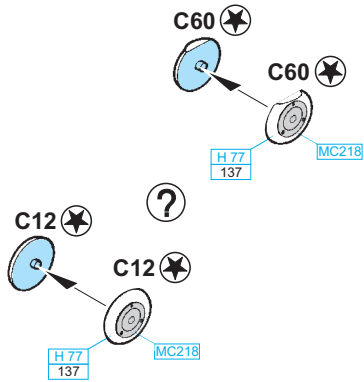
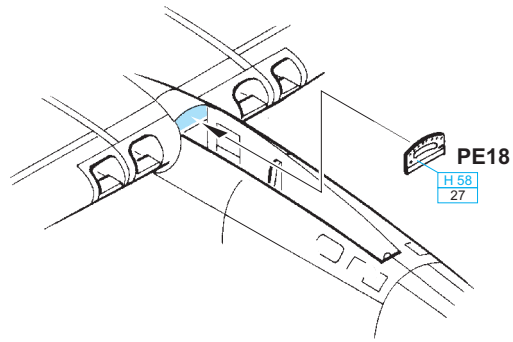

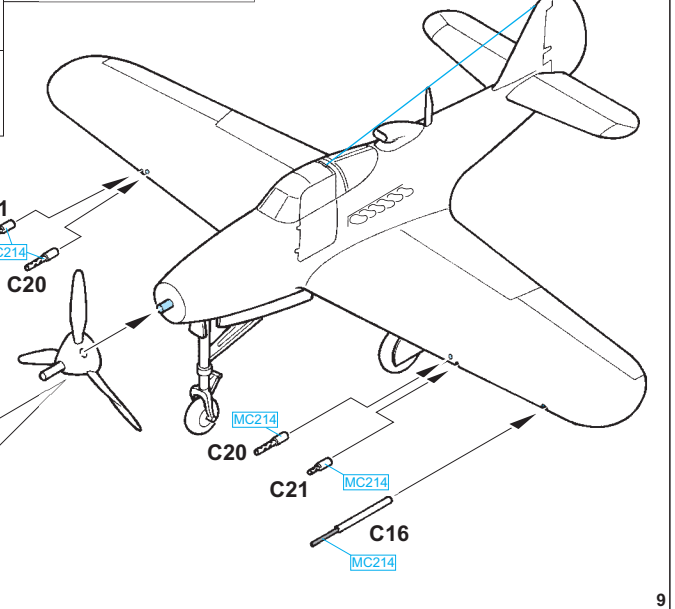
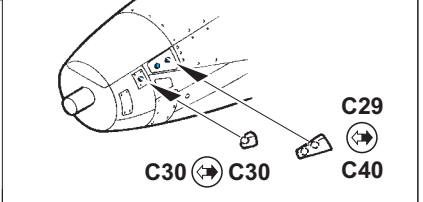
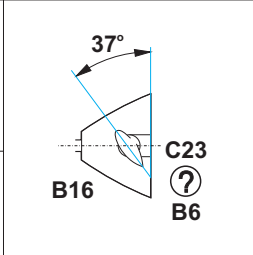
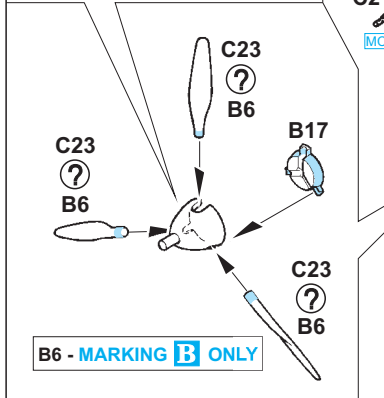
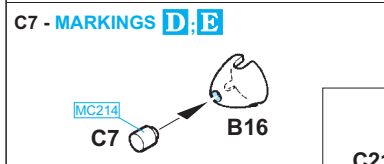
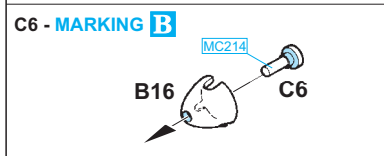
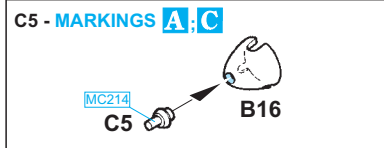
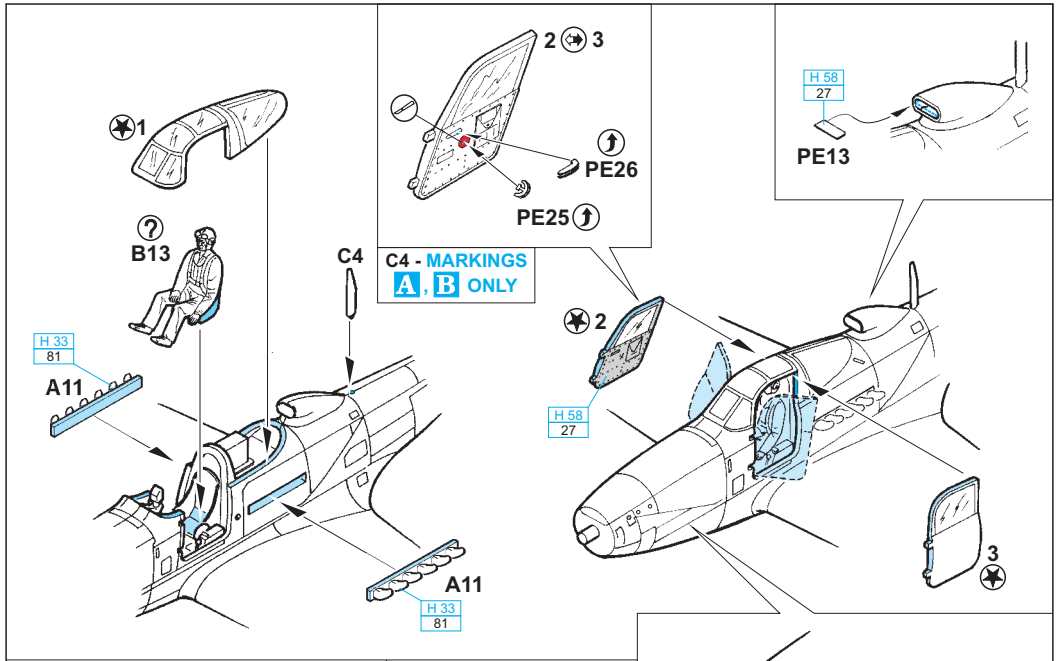

C2+C13
2 pcs.

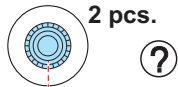

C50+C59
2 pcs.

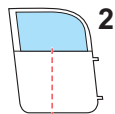
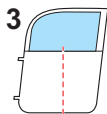
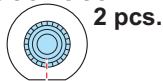

C12+C12
?

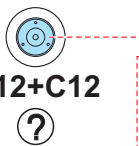

C60+C60

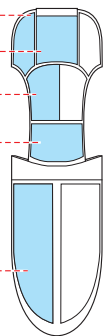
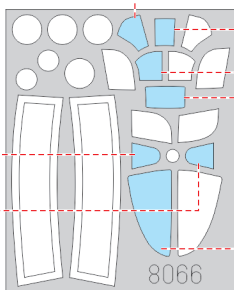
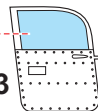
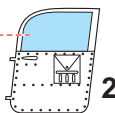
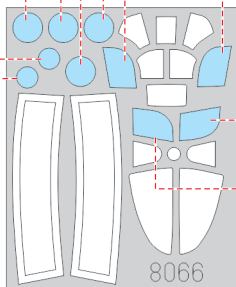
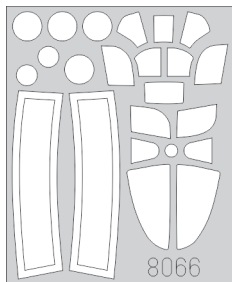

1.)

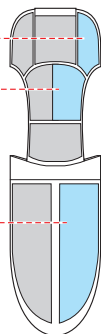
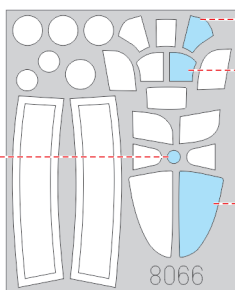
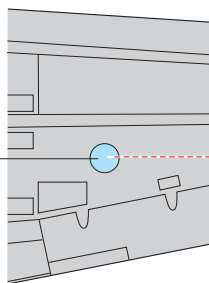

2.)

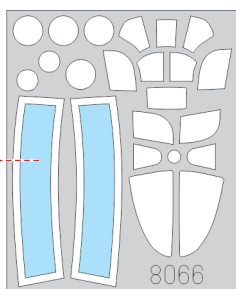
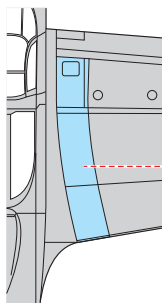

?

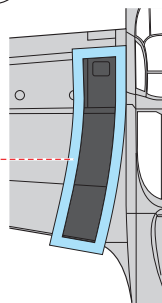
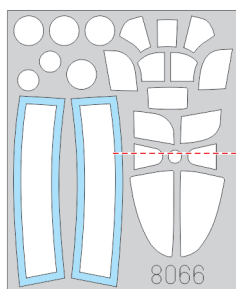

A P-39N, s/n 4218354, Flown by 345th FS, North Africa / Alghero Airfield, Sardinia, late 1943

This aircraft was probably flown by the CO of the 345th FS Maj. Charles W. Hoover. He led this squadron from August 7 to December 27, 1943. According to squadron documents, he is credited with 1 1/2 victories. Hoover downed a Bf 109 G from III./JG77 over Thelapte Air Base on January 15, 1943, but the date of his shared kill is not known. This Airacobra is the only known P-39 with sharkmouth frown in Mediterranean. The squadron's typical marking – the yellow stripes on the wings and on the tail, and the two-digit number, are missing. The squadron badge – the devil riding a hawk – is photographically documented on a few aircraft during the second half of 1943. The white surfaces on the tail and wings were probably intended to change the aircraft silhouette. For a time, this P-39 flew with reduced wing armament.

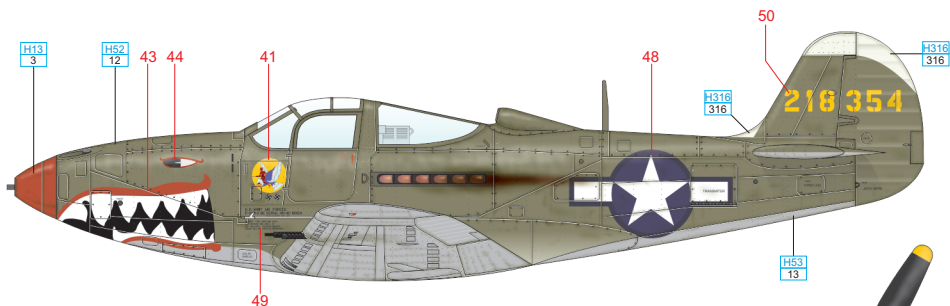

ČESKOU VERZI TEXTU NALEZNETE NA www.eduard.com/s/8066

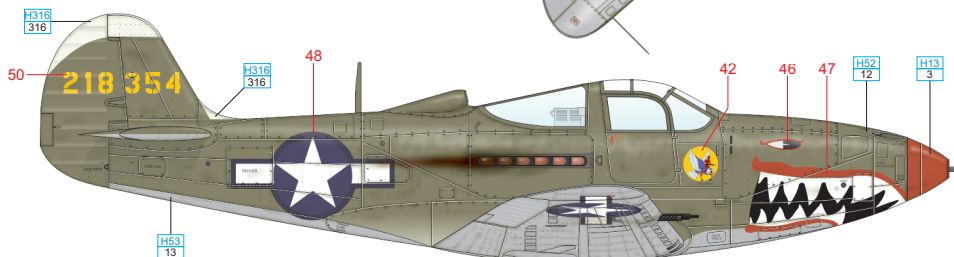
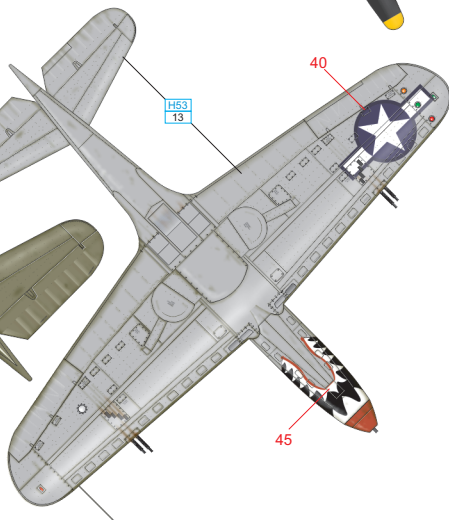
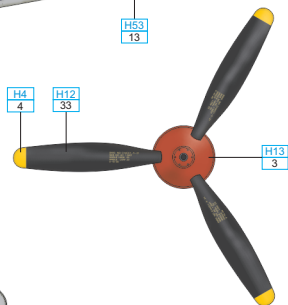
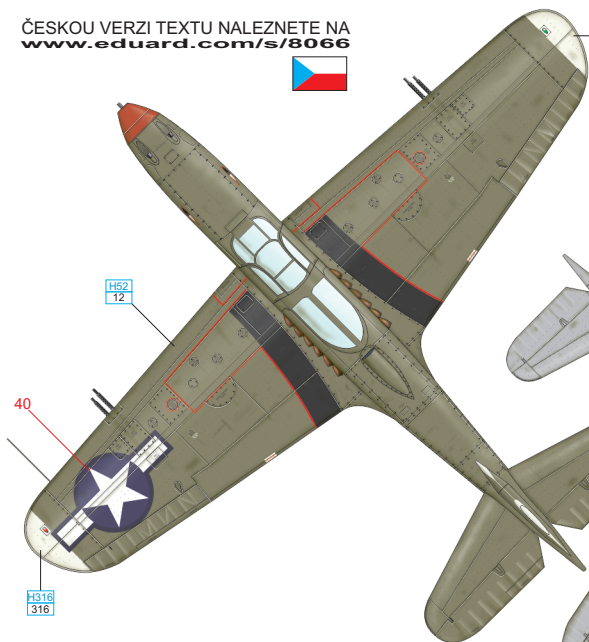

| | | | | | | | | | |
|--------|----------|-----|-------|--------------|--------|------------|--------|-------|--------|
| WHITE | H316 316 | RED | H13 3 | NEUTRAL GRAY | H53 13 | OLIVE DRAB | H52 12 | BLACK | H12 33 |
| YELLOW | H4 4 | | | | | | | | |

B P-39L, s/n 42-4514, 91st FS / 81st FG, Sidi Ahmed Air Base, Tunisia, September, 1943

This P-39 was manufactured in Olive Drab / Neutral Gray camouflage and the scheme depicted was applied on the aircraft in the United Kingdom. There is no information about the colors used, and the British desert scheme is an assumption on our part. As can be seen in period photos, a dark color was used to repair damaged surfaces. Again, the exact color is not known, but apart of the Olive Drab, some British or captured German or Italian color could have been used. The 81st FG moved to Morocco from the United Kingdom in late 1942 / early 1943. In October, 1943, the unit made its home in Sicily, and in December of the same year in Italy. In February, 1944, the group was sent to India and re-equipped with P-47 Thunderbolts.

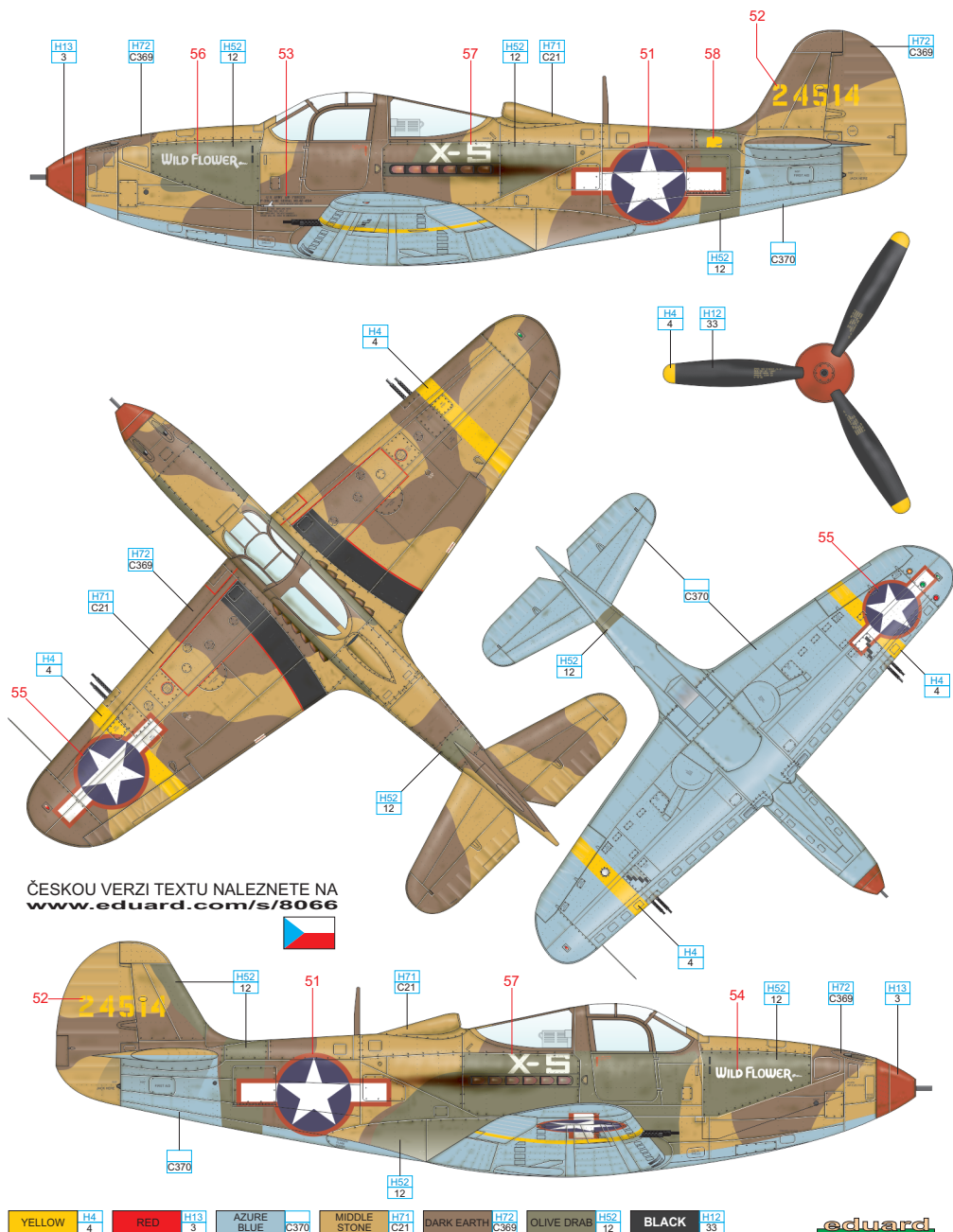

ČESKOU VERZI TEXTU NALEZNETE NA
www.eduard.com/s/8066



C P-39N, Flown by Lt. DeVore, 110th TRS/71st TRG, Gusap airfield, New Guinea, spring, 1944

The main task of the 110th Tactical Reconnaissance Squadron in the period from December 1943 to October 1944 was to support ground forces that fought against Japanese troops in New Guinea and the surrounding islands. The eagle was probably the unofficial squadron badge and was painted on the left cockpit door of most of the squadron's Airacobras. The white tail was a quick identification marking of 5th Air Force single-engined aircraft. It was introduced during mid 1943. This aircraft was previously flown by the 40th FS / 35th FG as can be deduced from the red tail tip.

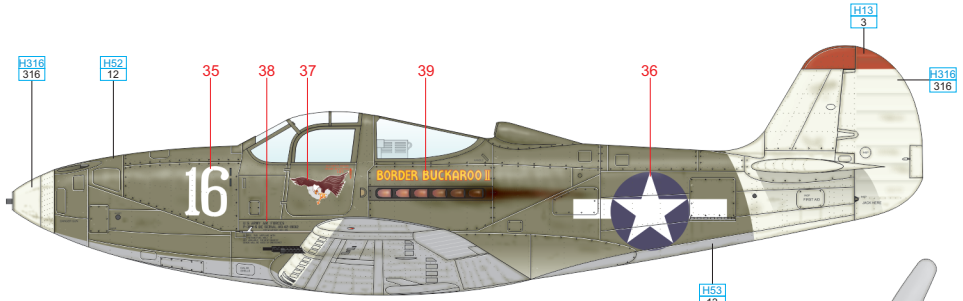

ČESKOU VERZI TEXTU NALEZNETE NA
www.eduard.com/s/8066

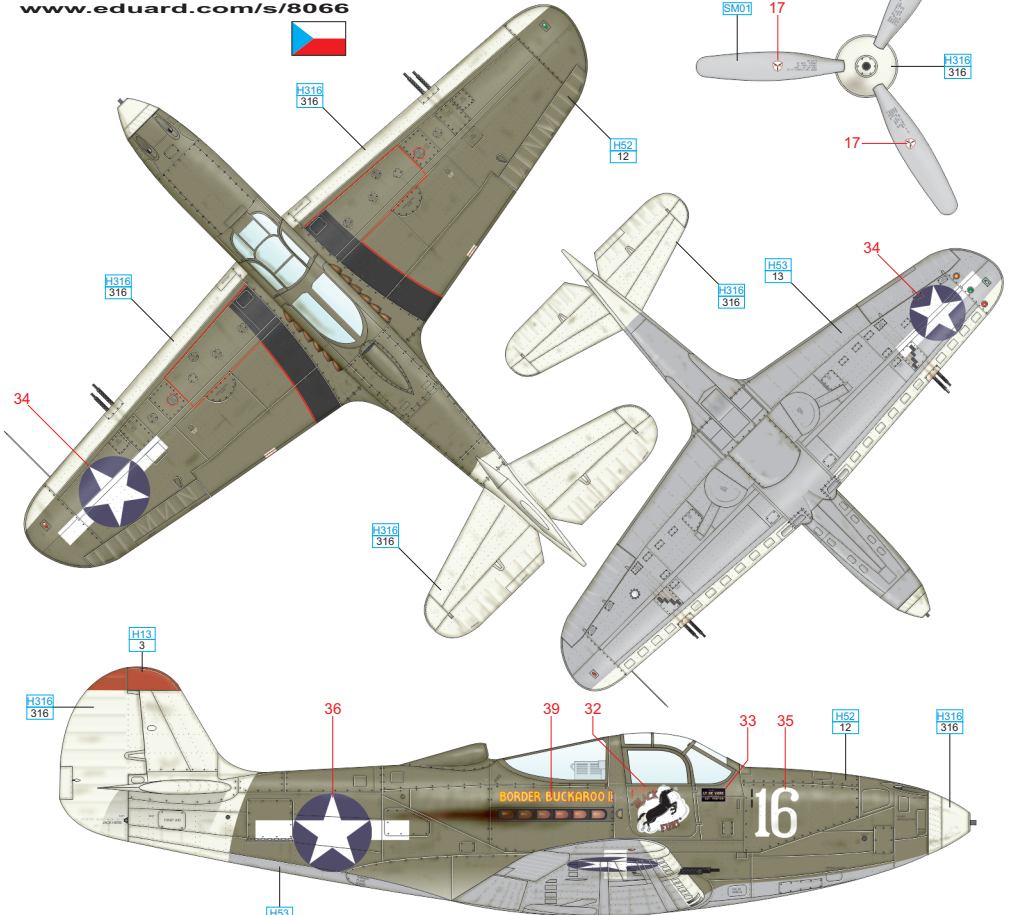

| | | | | | | | | | |
|--------|----------|-----|-------|--------------|--------|------------|--------|-------|--------|
| WHITE | H316 316 | RED | H13 3 | NEUTRAL GRAY | H53 13 | OLIVE DRAB | H52 T2 | BLACK | H12 33 |
| CHROME | SM01 | | | | | | | | |

D P-39N, Flown by Grigori A. Rechkalov, 16th GIAP, spring 1945

Rechkalov's airplane, especially the one with the nose kill marks, was formerly considered to be an aircraft flown by another Soviet fighter ace, Pokryshkin. The initial letters RGA on the tail confirm that it was flown by Grigori A. Rechkalov. Rechkalov stayed with his regiment through the whole duration of WWII. In July, 1941, when the German armed forces began the war against the Soviet Union, the regiment was known as the 55th IAP. Rechkalov was awarded the Gold Star of the Hero of the Soviet Union twice – on May 24, 1943 and on July 1, 1944. He was credited with 51 individual and 4 shared victories at that time and was appointed the CO of the 16th GIAP. Rechkalov's WWII score consists of 61 individual and 4 shared aerial victories. Many sources state that he flew two Airacobras – P-39N 42-8747 and P-39Q 44-2547. The detailed analysis of existing photos suggests the theory that Rechkalov flew the P-39N only. The different serial number appeared on this aircraft when the damaged tail unit was repaired using spare parts from the P-39Q.

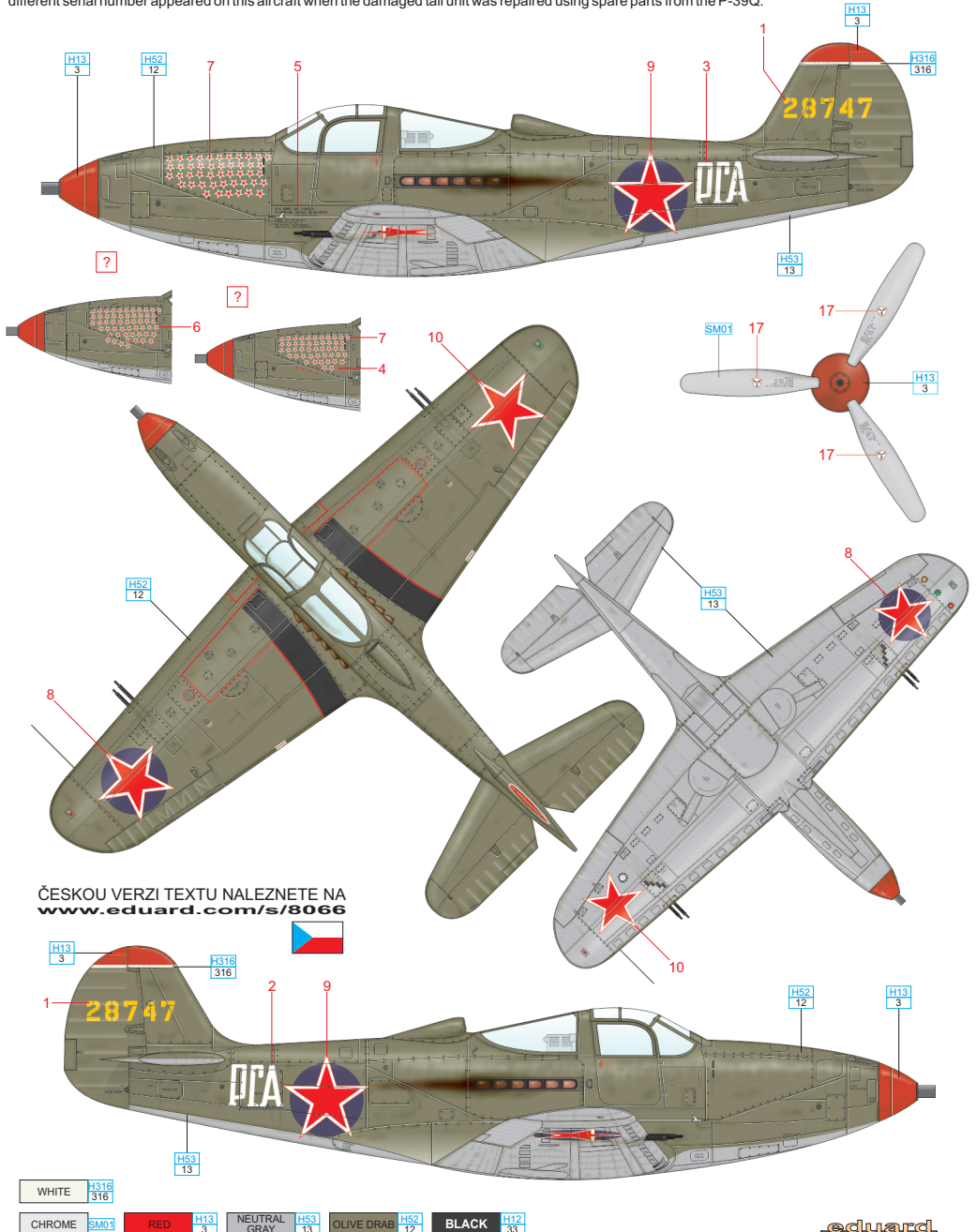

E P-39N, Flown by Nikolai G. Sobolev, 21st GIAP, April 1943

This aircraft was one of ten P-39Ns that were purchased thanks to the fund-raising efforts of Kristina Shumkova, a collective farmer from Krasnoyarsk city. These Airacobras were handed over to the 21st GIAP pilots. The exact serial number of this aircraft is not known, but temporary documents state that three P-39Ns were painted with the inscription 'Krasnoyarskiy Komsomlets' – 42-9285, 42-9300 and 42-9295. This aircraft was flown by LtCol. Nikolai Sobolev. Sobolev was the CO of the 21st GIAP and the fighter ace is credited with 17 aerial victories (9 individual and 8 shared). He started to fly this aircraft from April 1942 but it was flown by other pilots as well. Sobolev was a member of 21st GIAP (till May 3, 1942 under the designation 38th IAP) from the very first day of WWII. He was appointed flight leader, and in June, 1942 he became the CO of the regiment, in September, 1943 the deputy CO of the 304th IAD and finally he joined the Military Air Academy. Sobolev was forced to leave the Soviet Air Force shortly after the war when the NKVD (military secret service) took an interest in him.

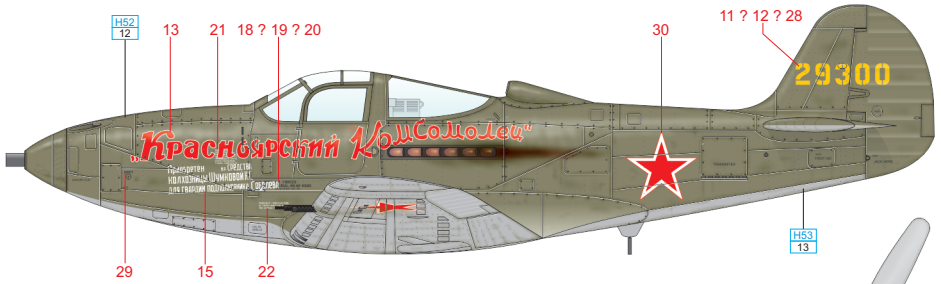

ČESKOU VERZI TEXTU NALEZNETE NA
www.eduard.com/s/8066

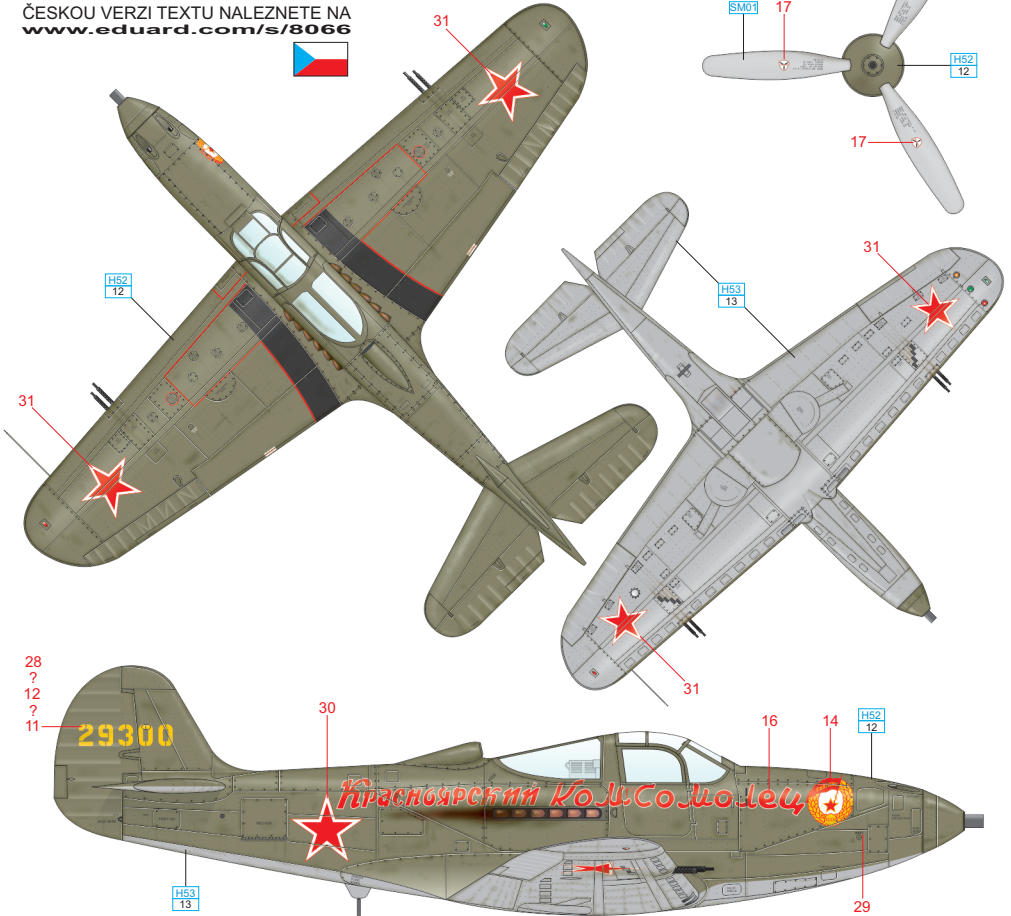

CHROME SM01 NEUTRAL GRAY H53 13 OLIVE DRAB H52 12 BLACK H12 33

eduard

