

1:700 SCALE

ITEM NO.05731

USS DD-537 THE SULLIVANS

美国海军苏利汶号驱逐舰DD-537

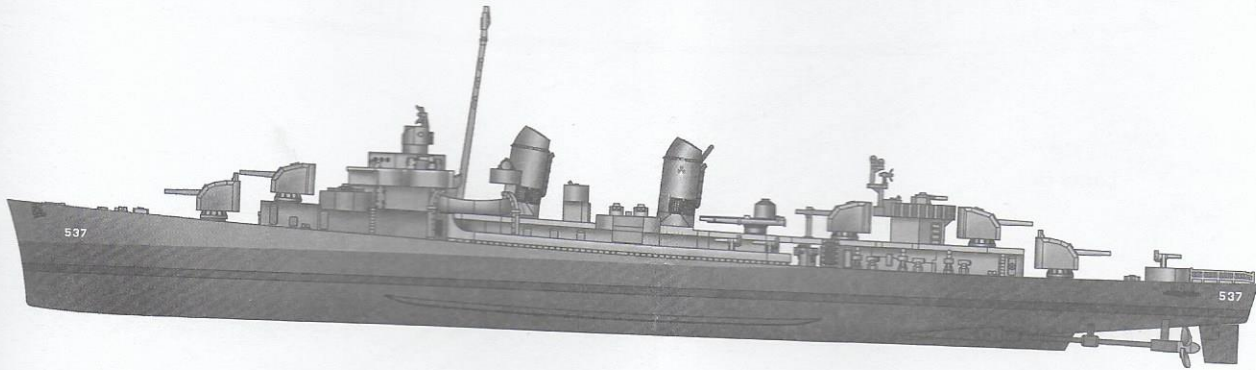

READ BEFORE ASSEMBLY:

- This kit is not recommended for inexperienced modelers or for children under 14 years of age
- Study and understand these instructions thoroughly before beginning assembly
- When needed, remove photo-etch parts carefully using a modeling knife or photo etch sprue cutter, being careful not to damage or lose small parts
- Take extra care in handling photo etch parts in order to avoid injury
- Apply instant cement sparingly to photo etch parts where instructed
- Tools recommended(not included in kit):Plastic and instant cements,sprue cutters,long nose pliers,,modeling knife, small files, tweezers, pin vise & scissors. Soft cloth and sandpaper will also assist in construction
- Glue and paint are not included in the kit. Use plastic cement and hobby paints only. Color guide for purchasing paint is included in the kit.
- Keep out of reach of small children. They must not be allowed to ingest small parts or handle plastic bags in any way.

装配之前仔细阅读

- 小心用模型锉刀锉平所有零件表面的注射浇口。
- 小心用刀片切下蚀刻片零件，不要遗失小零件。
- 用强力快干胶水粘合蚀刻片零件和金属轴。过量的快干胶水使用可能导致可动零件会粘住，小心涂胶。
- 取蚀刻片时应特别注意安全，防止利边划伤手指。
- 某些零件表面需贴上水贴纸，请选择在装配的同时进行。
- 推荐模型工具(自备)：胶水，水口剪刀，长咀钳，刀片，锉刀，镊子钳，钻，剪刀，瞬间快干胶。
- 软布同砂纸同时也应该是必备工具。
- 请使用塑料胶水和油漆，模型内不含。
- 谨防小孩吸吮塑料零件，或者将塑料袋套在头上，制作时应将套材远离小孩接触。
- 本产品不适合14岁以下没有经验的模型爱好者



cyanocrylate glue
使用强力胶



weight
配重



make hole
钻孔



cut / remove
切除



bend
弯曲



file / sand
锉平



option
选择



no cement
不涂胶水



decal
贴纸

水贴纸的使用:

DECAL APPLICATION:

1. 从水贴纸上剪下印花;
2. 将印花放入温水中浸10秒，然后放在干净布上。
3. 拿着印花纸板将印花移到模型上;
4. 手指蘸水将印花移到适当的位置;
5. 用软布轻压印花直至水干，气泡消失。

1. Cut decals from sheet as needed
2. Dip the decal in warm water for about 10 seconds and then place on soft clean cloth.
3. Hold the decal backing sheet edge and gently slide the decal onto the model in its proper position.
4. While still wet, decal can be adjusted for better fit on model by dampening it gently with your finger.
5. When placed in the proper position, gently press decal down with a soft cloth until excess water and air bubbles are gone.
6. Allow decal to dry completely before handling model

5731

部品图 parts:

《上船体》
Upper Hull

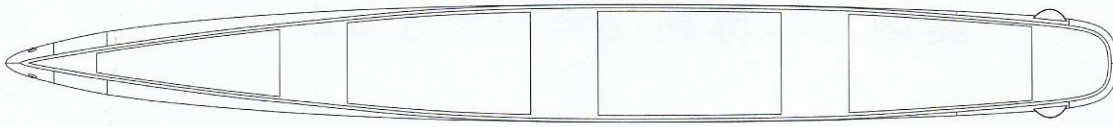

《下船体》
Lower Hull

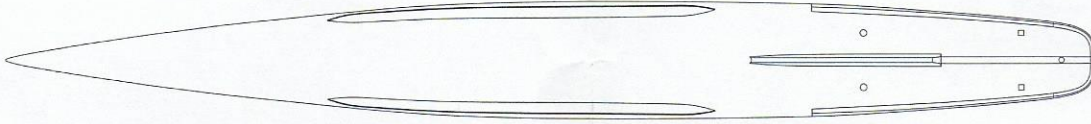

《水线板》
Waterline plate

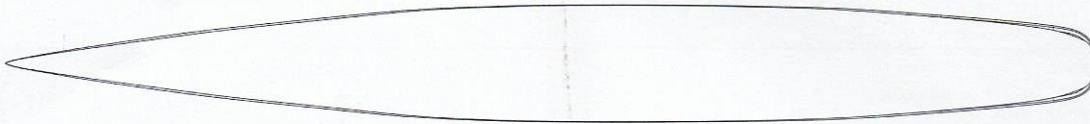

《甲板》
deck

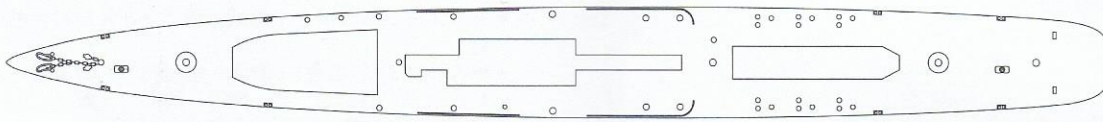

A

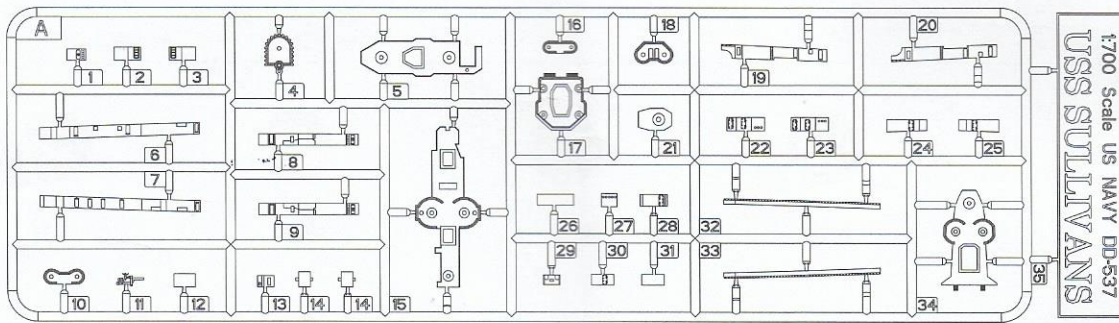

B

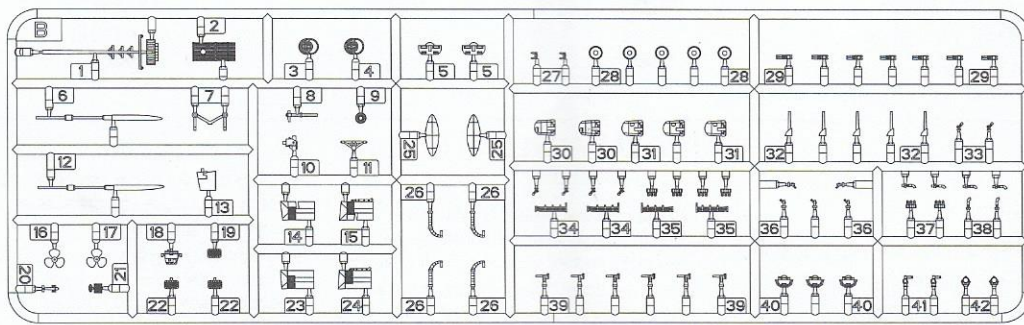

《贴纸》
Decal



1

MK30 GUN MOD30
MK30炮 30型

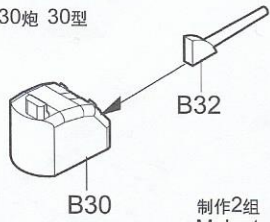

《甲板》
deck

《上船体》
Upper Hull

MK30 GUN MOD30
MK30炮 30型

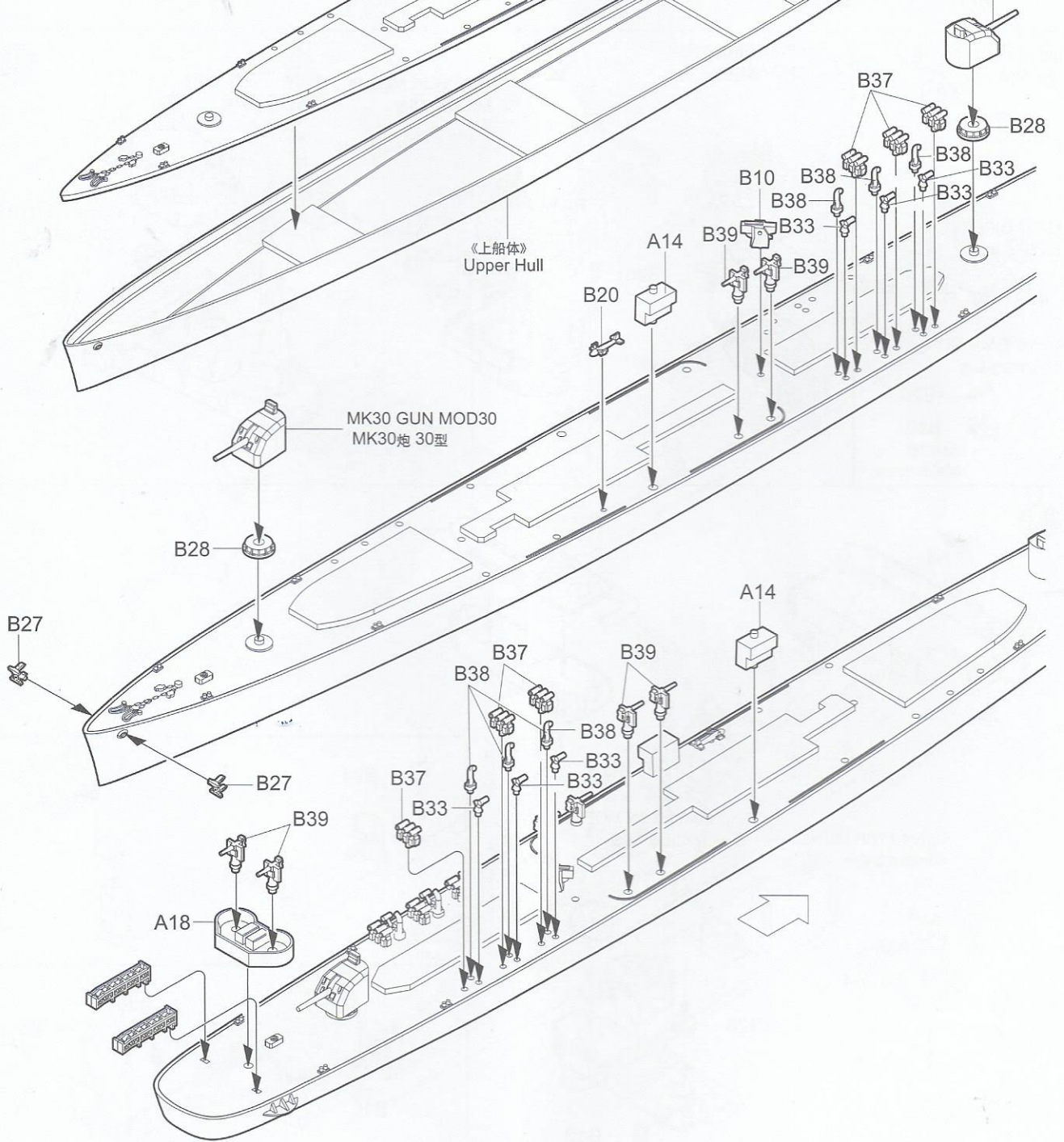

2

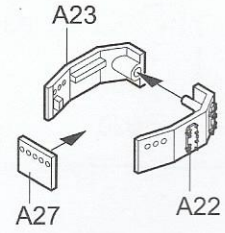
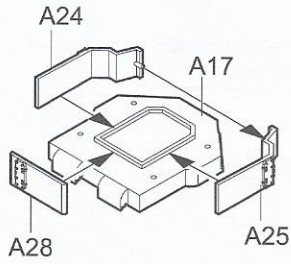
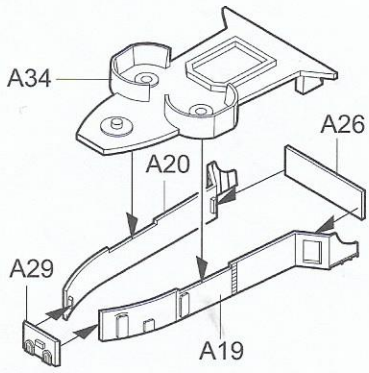

MK30 GUN MOD18
MK30炮 18型



MK37 DIRECTOR
MK37指挥仪



40mm TWIN GUN
40mm双联装炮



MK37 DIRECTOR
MK37指挥仪

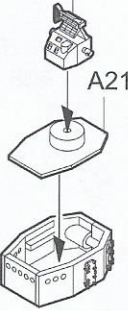

MK30 GUN MOD18
MK30炮 18型

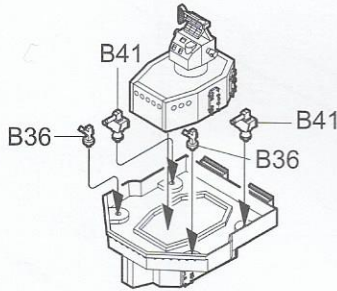

40mm TWIN GUN
40mm双联装炮

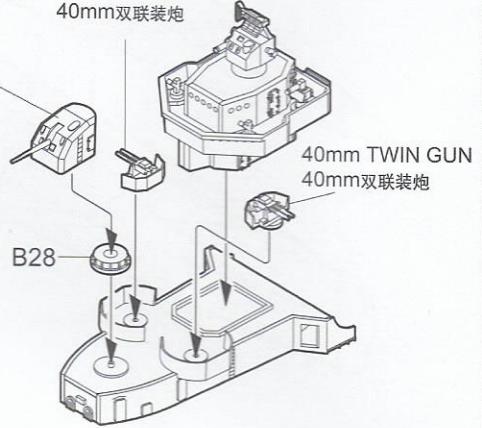

3

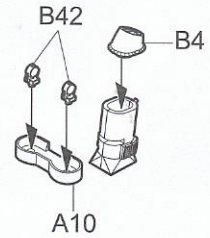
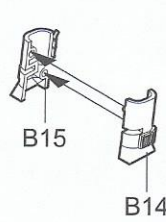
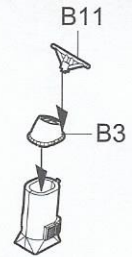
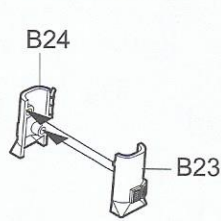
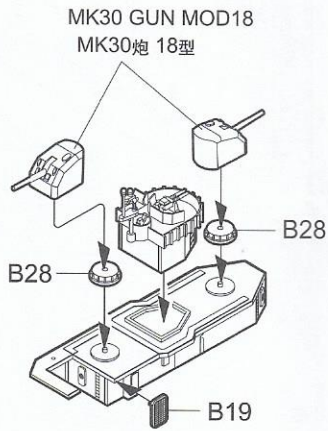
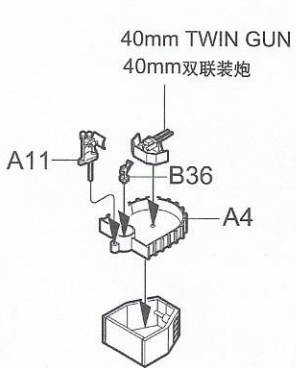
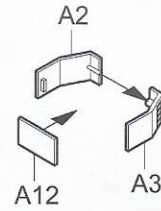
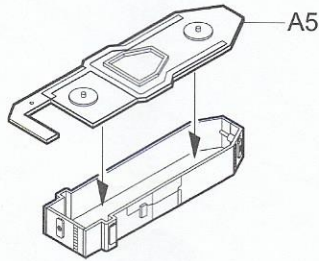
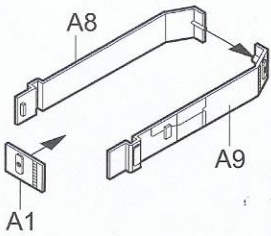

05731

4

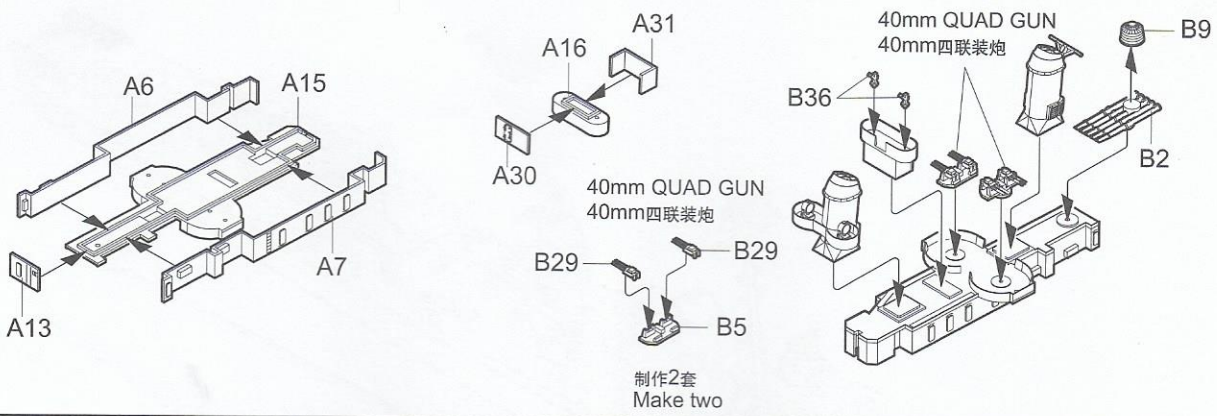

5

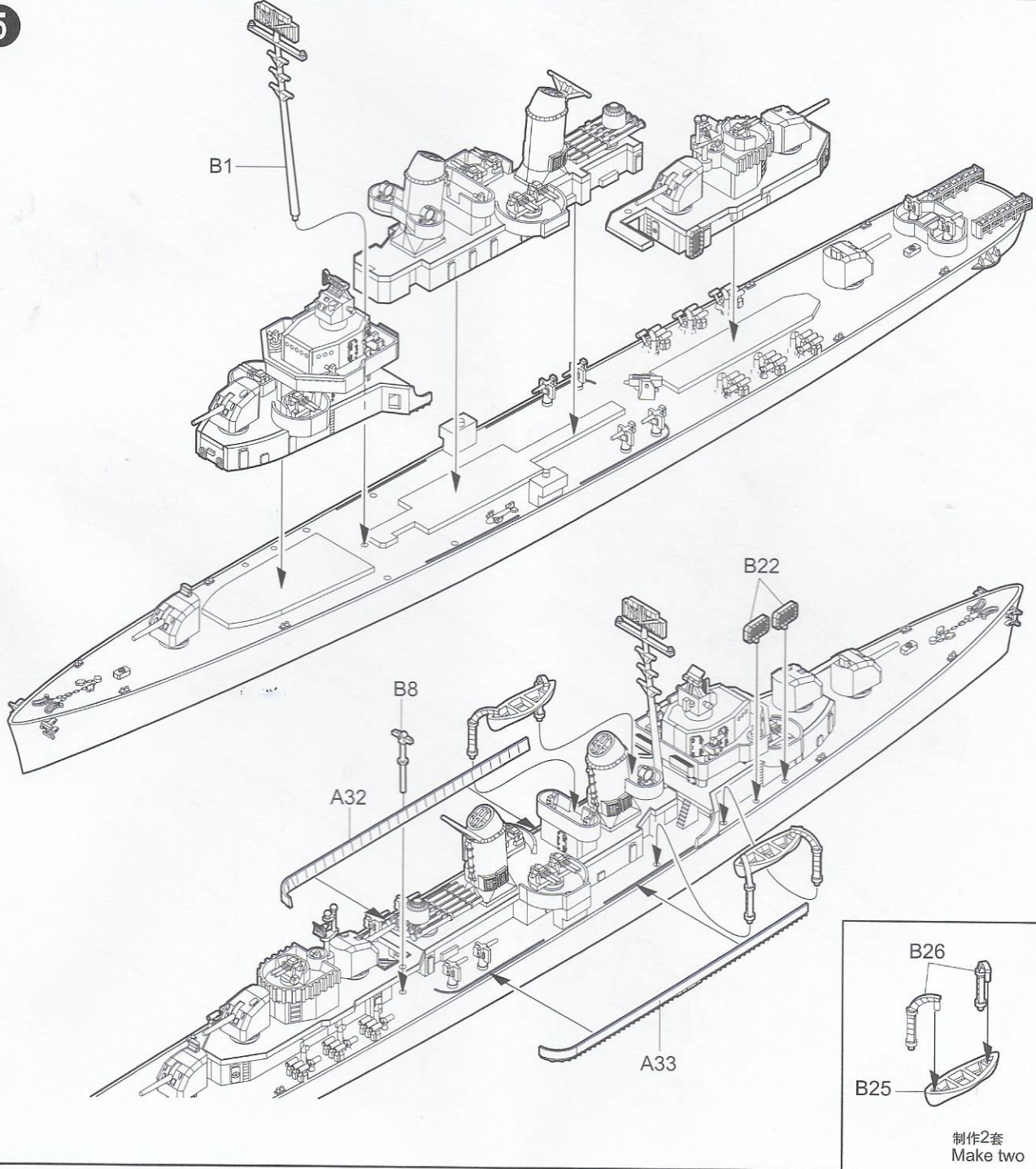

05731

5

6

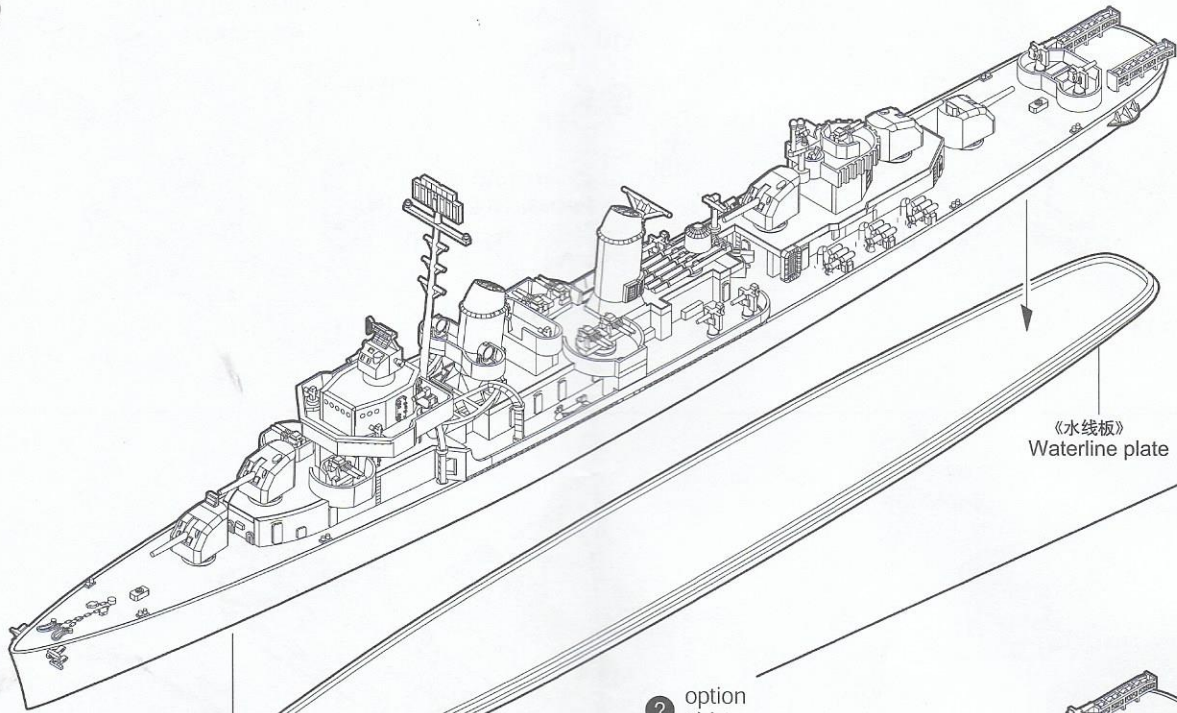

? option
选择

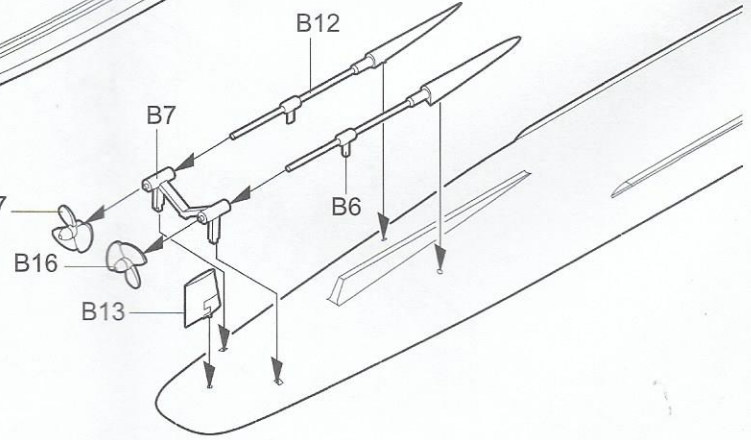
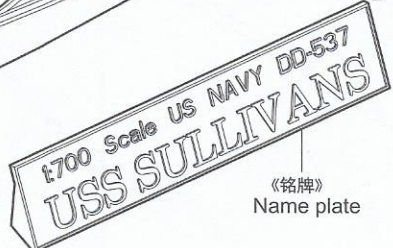
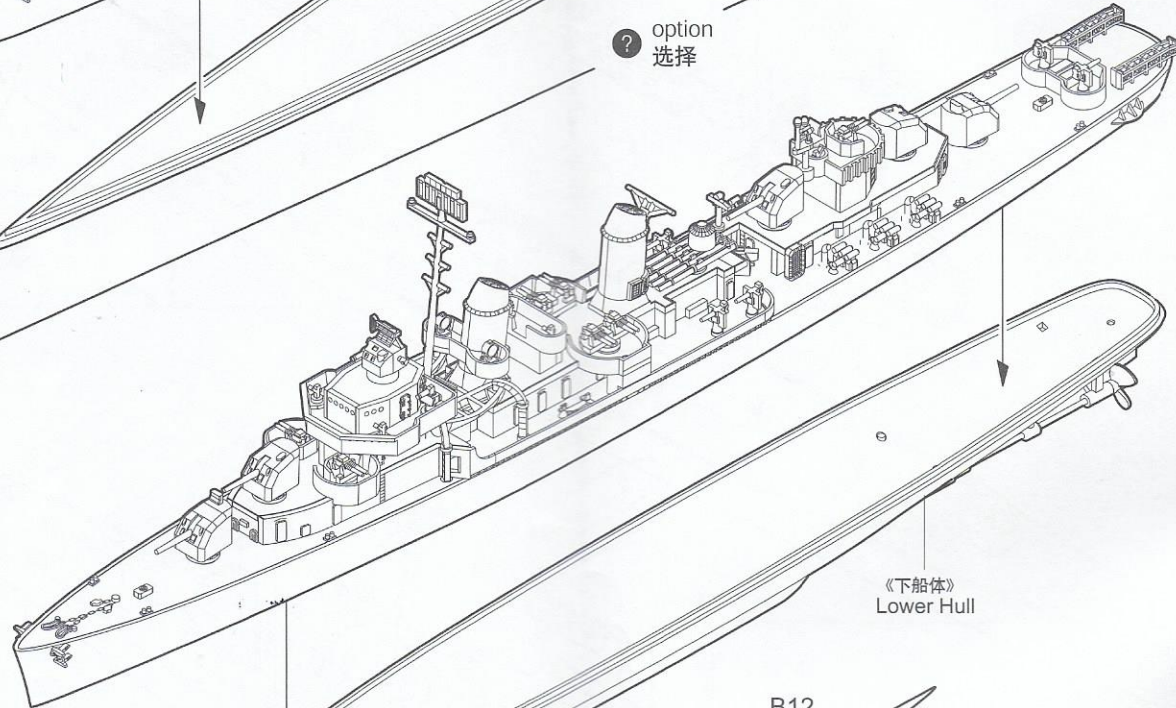

05731

6

涂装同标贴指示

Painting & Marking guide

郡仕色使用

Gunze Mr. color used

Gunze	郡仕色	Mr. color
H 9 9	金色	GOLD
H 53 13	雾灰	HAZE GRAY
H 54 14	海军蓝	NAVY BLUE
H 17 29	粉底红	COCOA BROWN
H 12 33	消光黑	FLAT BLACK
H 365 365	甲板蓝	DECK BLUE

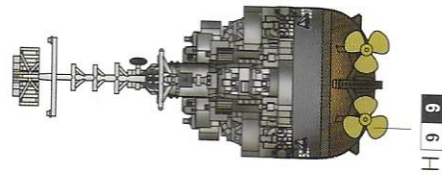

H 9 9

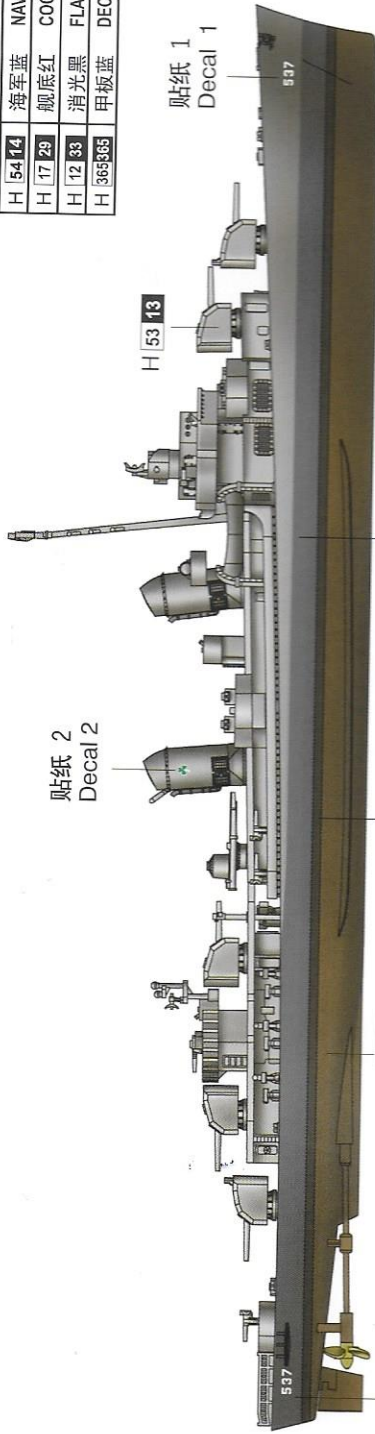

贴纸 3
Decal 3

H 17 29

H 12 33

H 54 14

H 53 13

贴纸 1
Decal 1



H 365 365

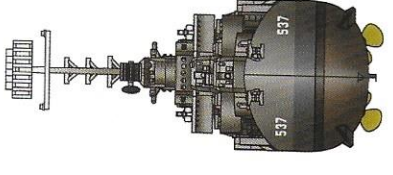

H 9 9

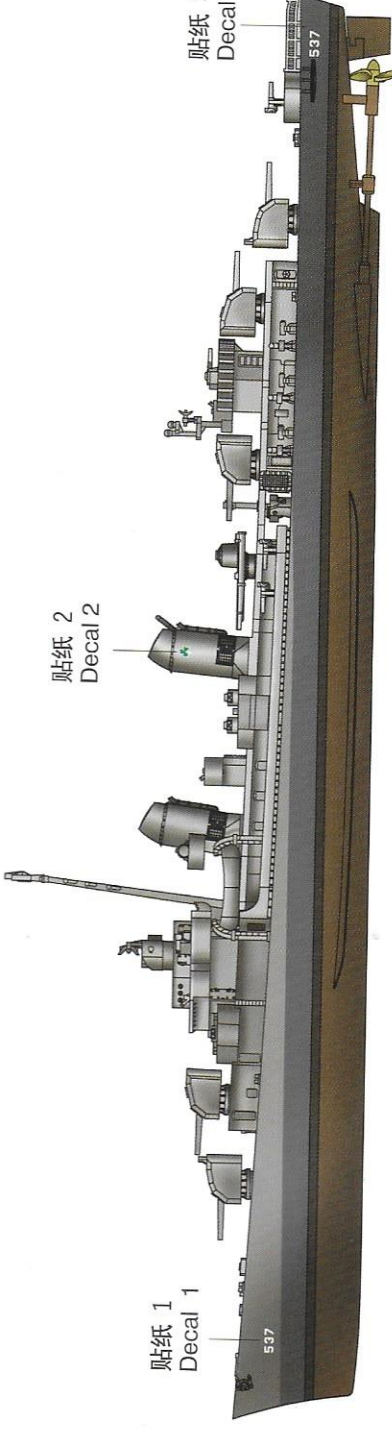

贴纸 1
Decal 1

贴纸 2
Decal 2

贴纸 3
Decal 3

H 8 GUNZE SANGYO AQUEOUS HOBBY COLOUR

8 GUNZE SANGYO MR. COLOUR

05731 1/700 USS THE SULLIVANS DD-537