

◉ K'S WORKSHOP ◉

2008 YZR-M1 #46/#48 Trans kit

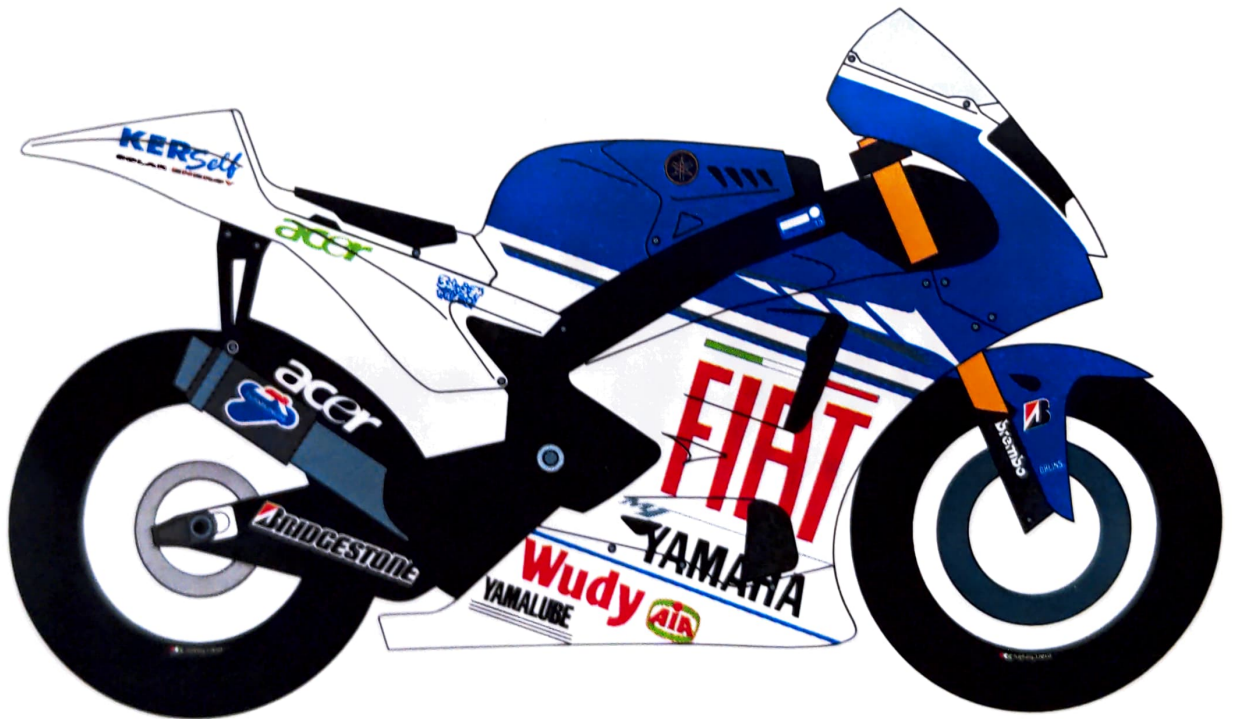

◊ K'S WORKSHOP ◊

GRAND PRIX MACHINE SERIES 

2008 YZR-M1 #46/48 Trans Kit

- ・ このキットはレジンパーツを使用するガレージキットで、中・上級者向けの模型です。
- ・ このキットを製作するには別途TAMIYA製キット「'09 YZR-M1 (ITEM #14117)」が必要となります。
- ・ 小さな部品やビニール袋は小さなお子様が手にすると、思わぬ事故を引き起こす可能性があります。危険のないよう保管場所にはお気を付け下さい。
- ・ 各パーツには離型剤が付着しておりますので、洗剤等で洗浄してから工作して下さい。

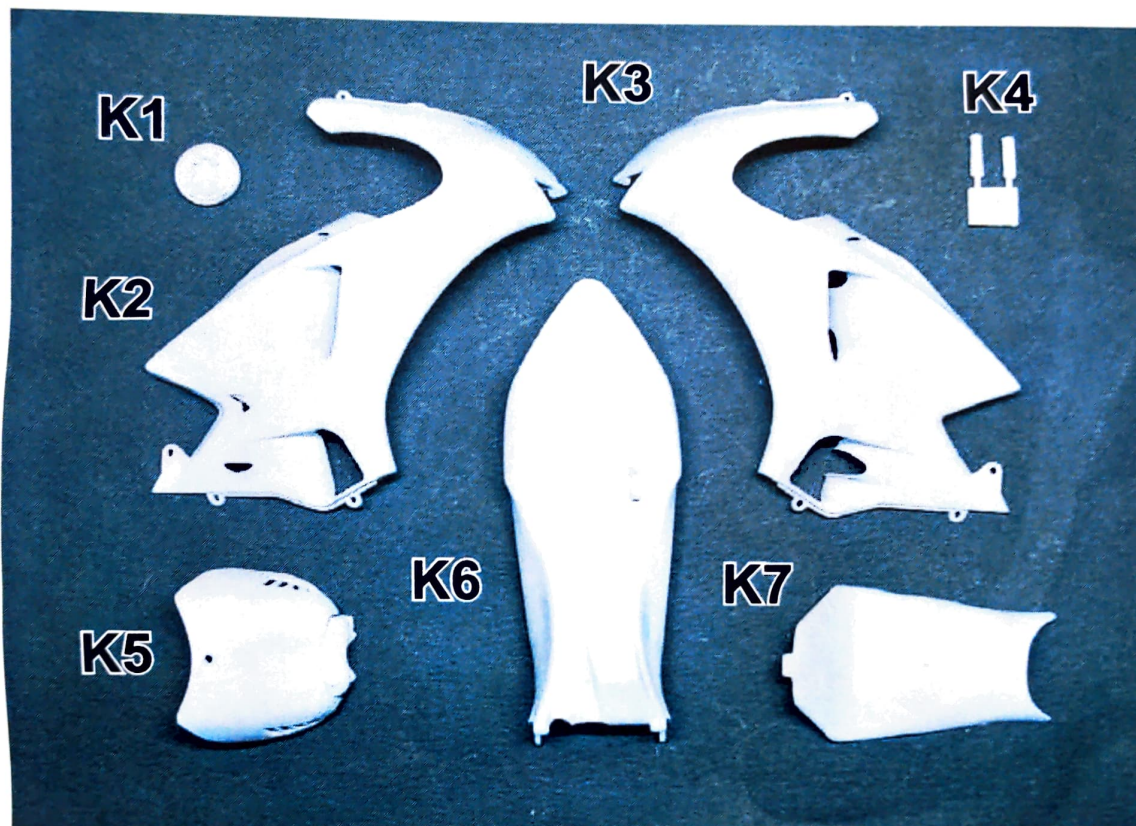

contents

・ Resin Parts	7
・ Decal Sheet	1
・ Manual	1

タミヤのキット'05 YZR-M1(14116)のフロント周りのパーツ(写真参照)が別途必要になります。

You also need some parts from TAMIYA kit "'05 YZR-M1(14116)". Please see the photo.

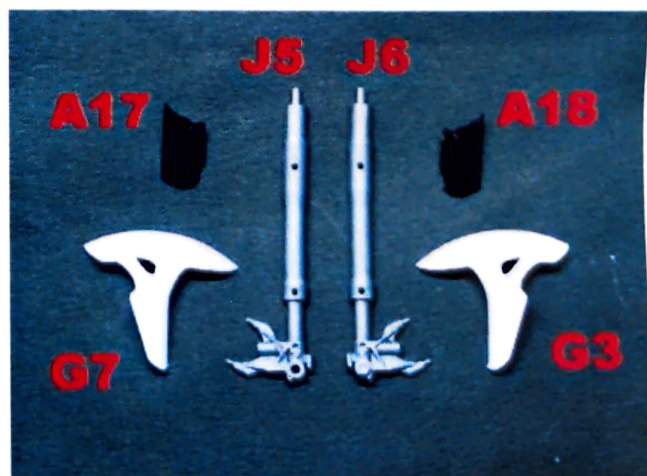

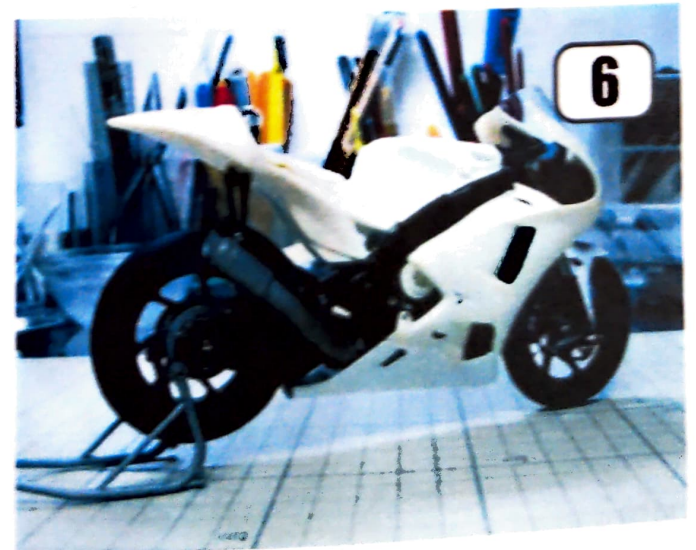
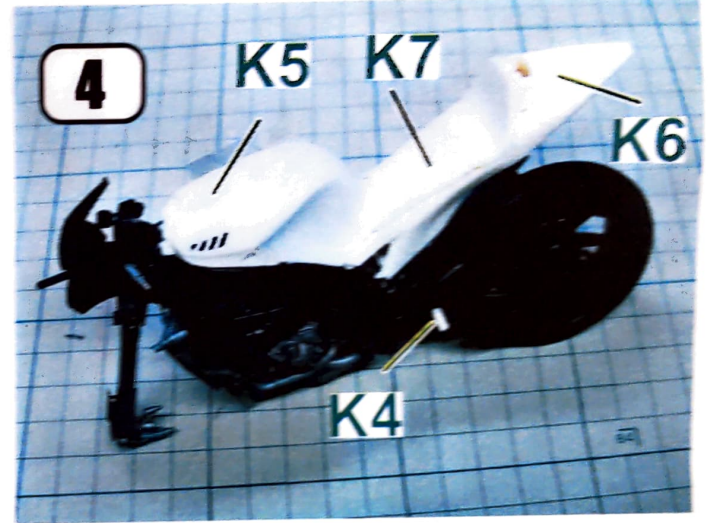
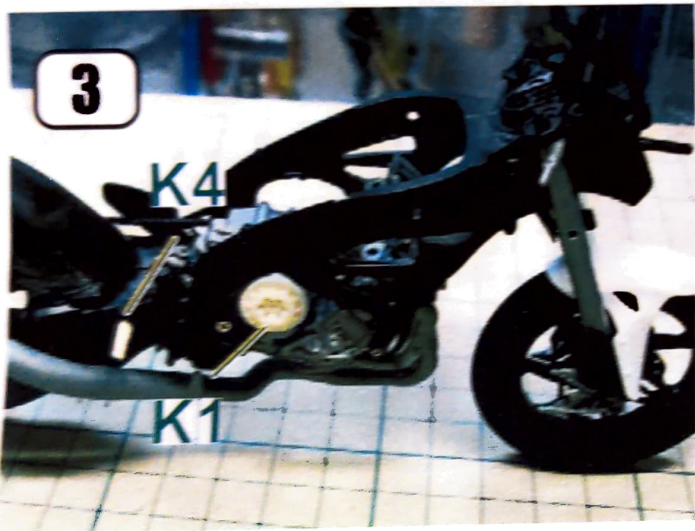
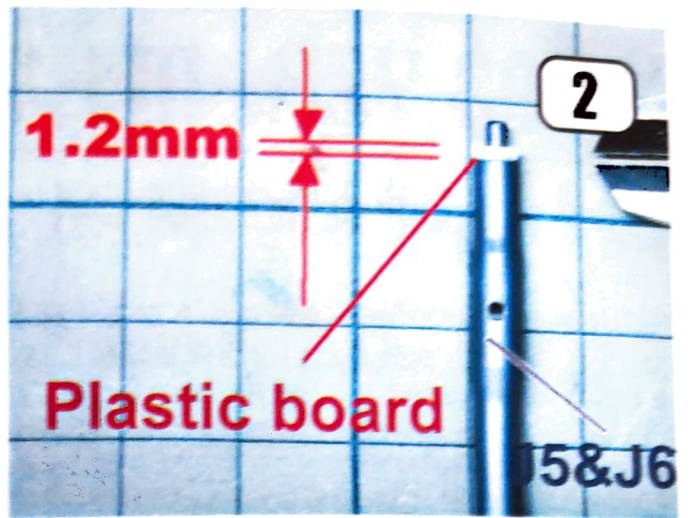
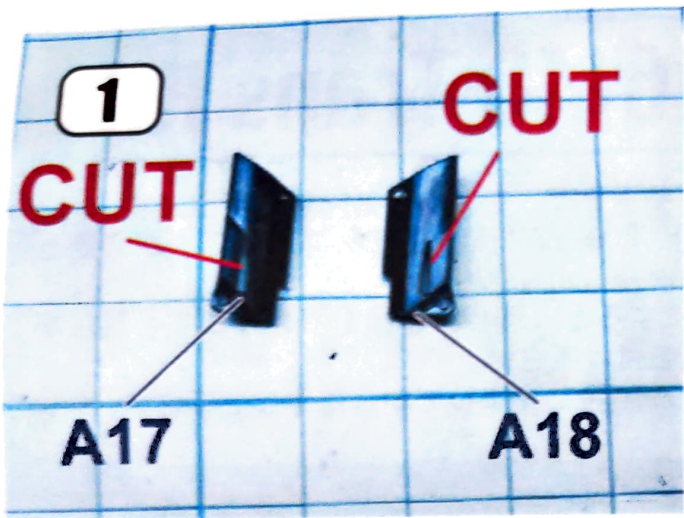



DECAL

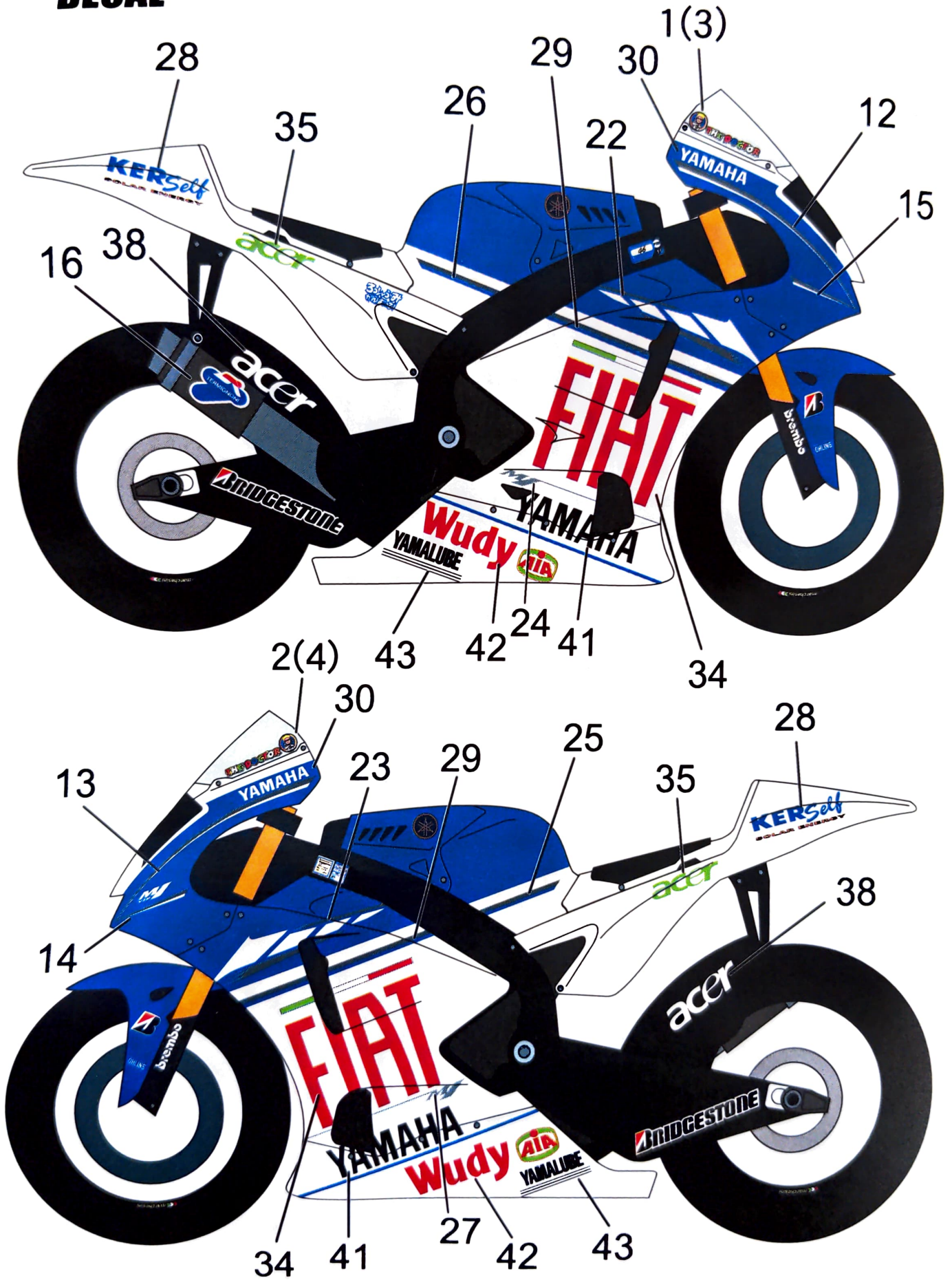

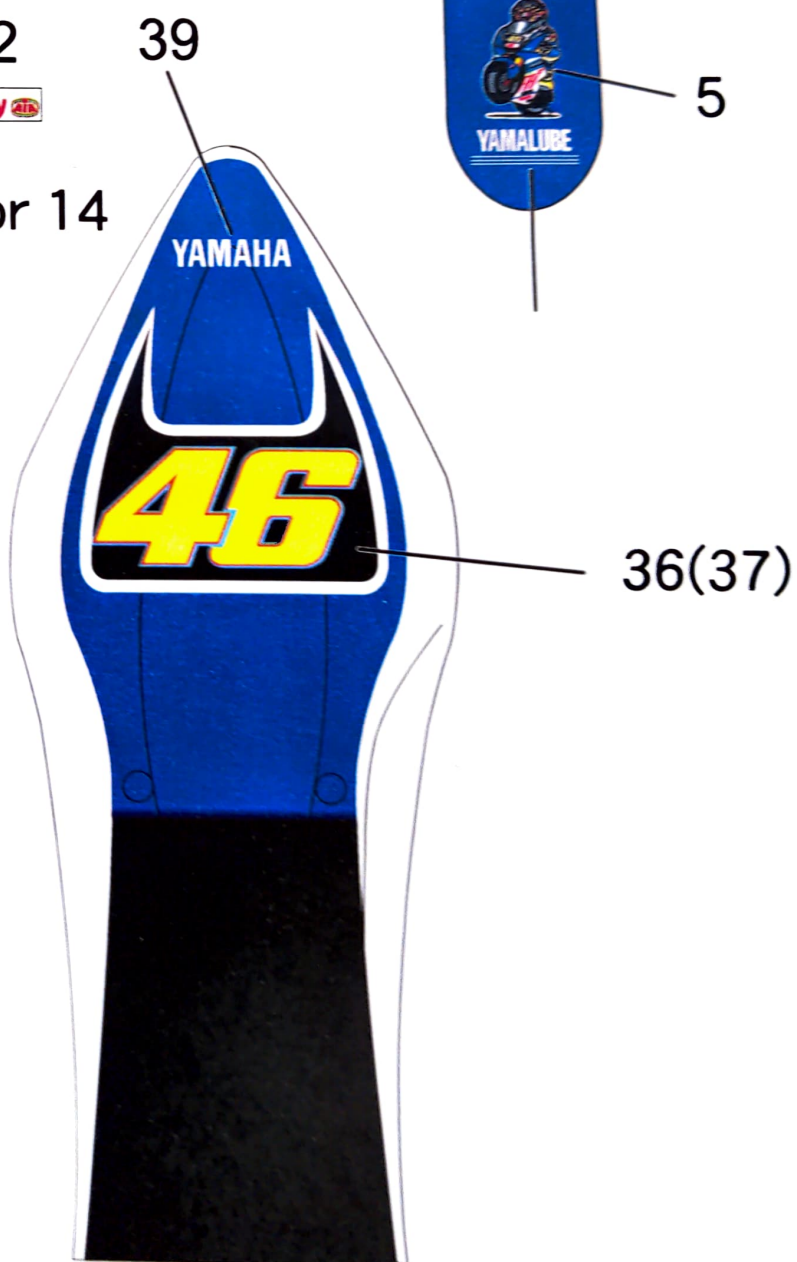
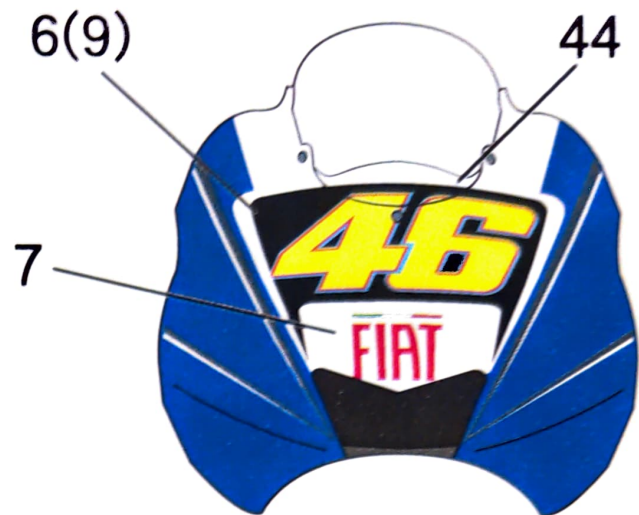
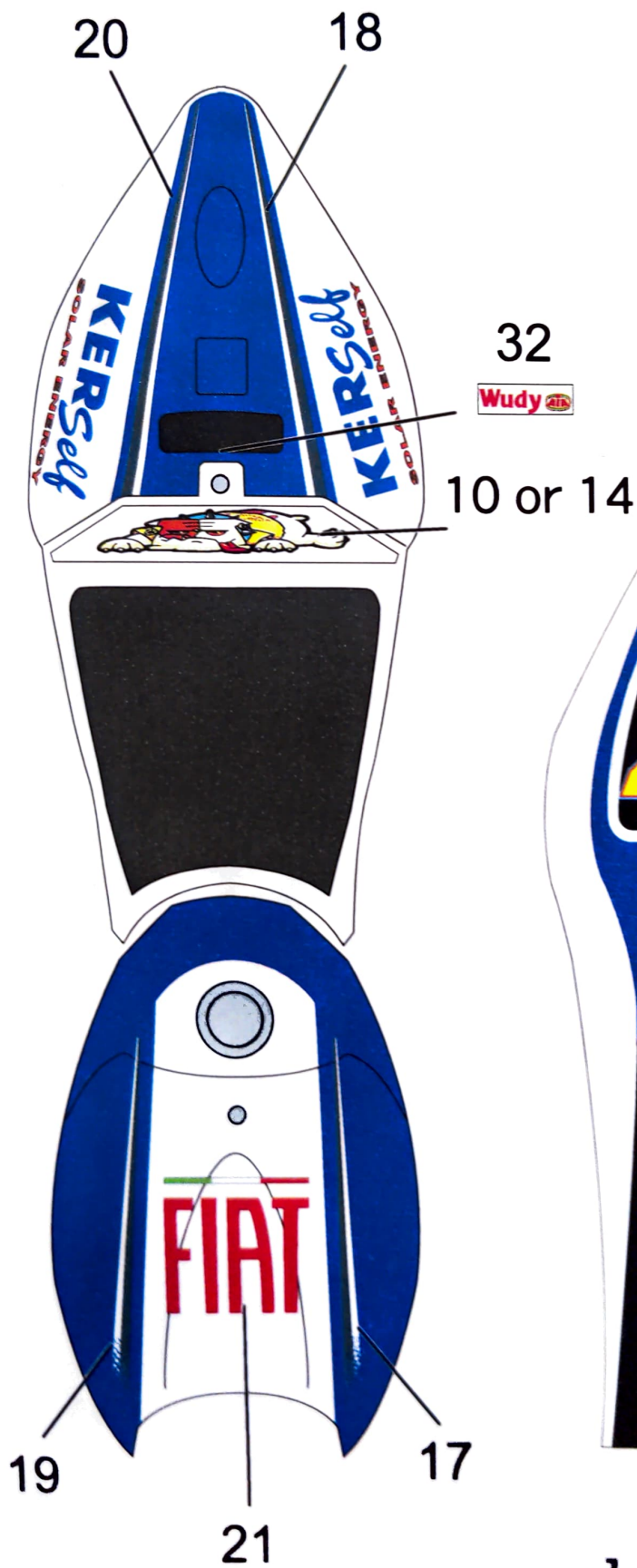

◊ K'S WORKSHOP ◊
GRAND PRIX MACHINE SERIES 