

Sea Knight

CH-46D/E

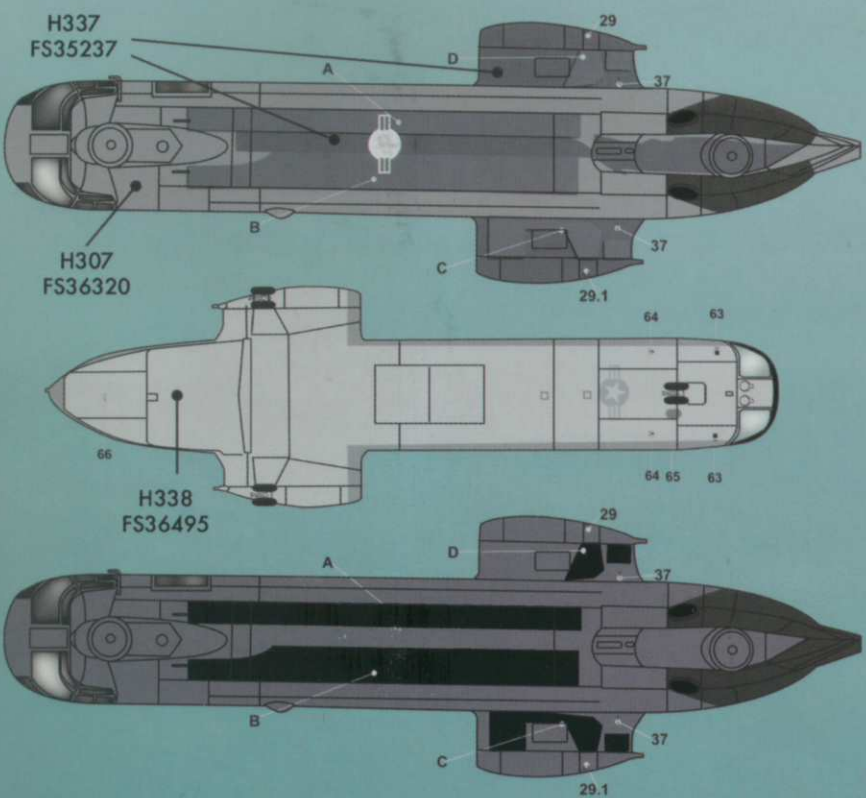

ZTZ48/028



RESEARCHED BY ELI RAPHAEL



• Upper Hotel California & Mars view

H # refers to Gunze Sankyo colors

CH-46D HC-11
"Gunbearers"
DET-1 # 153319

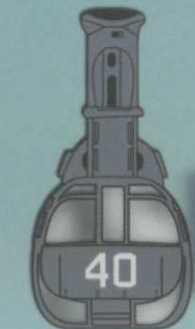
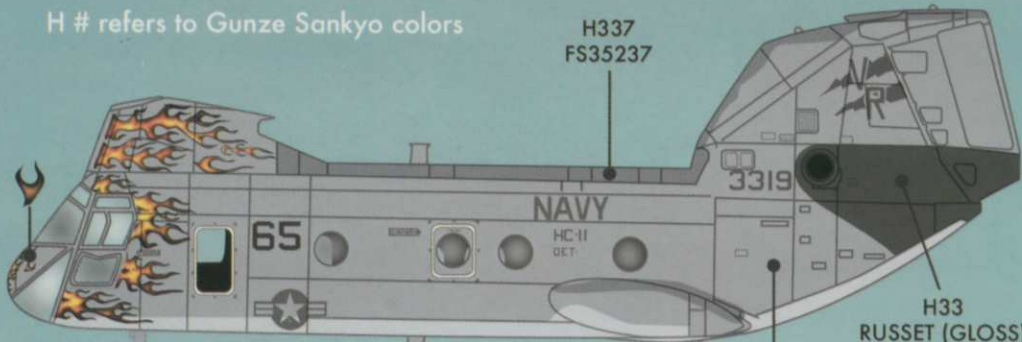
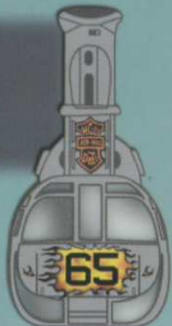

"Pack Rats"
HC-3 DET-104
154000 "Mars"

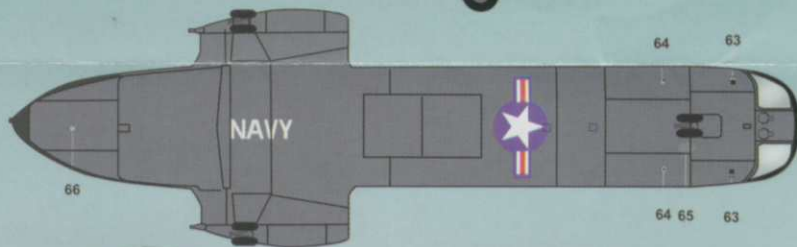
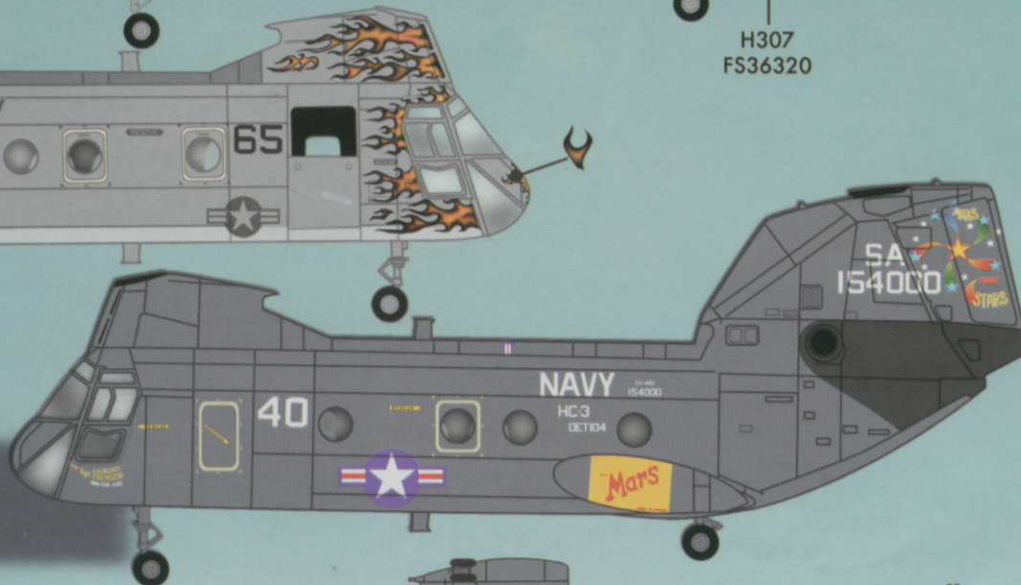

"Pack Rats"
HC-3 DET-106 154832
"Hotel California"

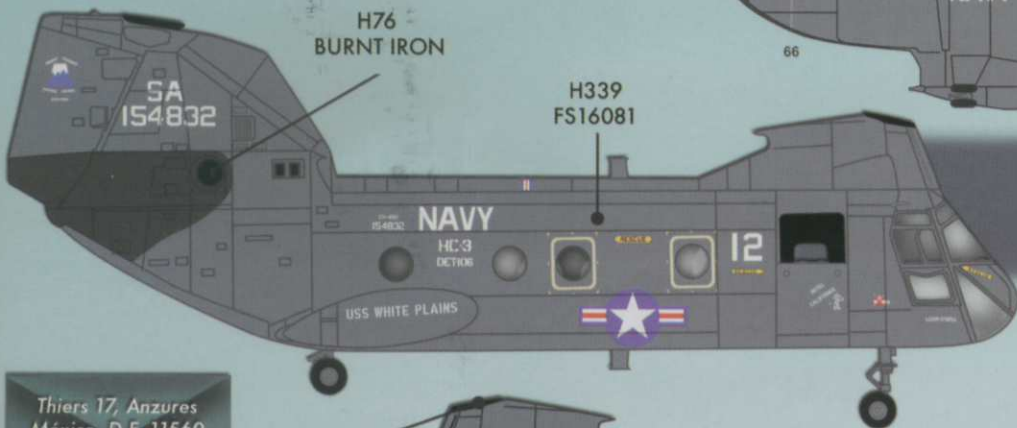

Thiers 17, Anzures
México, D.F. 11560
www.zofzdecals.com
zofz17@yahoo.com

H77 TYRE BLACK

H77 TYRE BLACK

H2 GLOSS BLACK

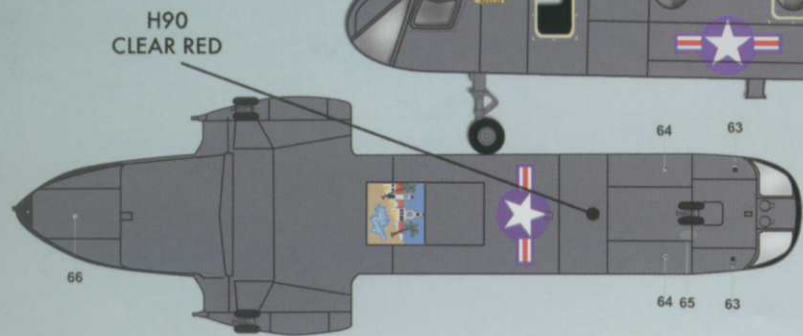

Thanks to Roberto Sanchez,
Joe Szczygiel, 1LT Jonathan
Bernstein, CW2 John Rawls
and Fotios Rouch for making
this decal possible.

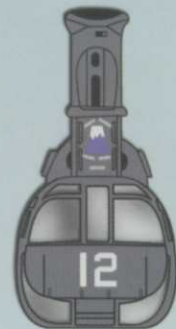

HMM-263 PHOTOS USED WITH PERMISSION BY
CW2 JOHN RAWLS.

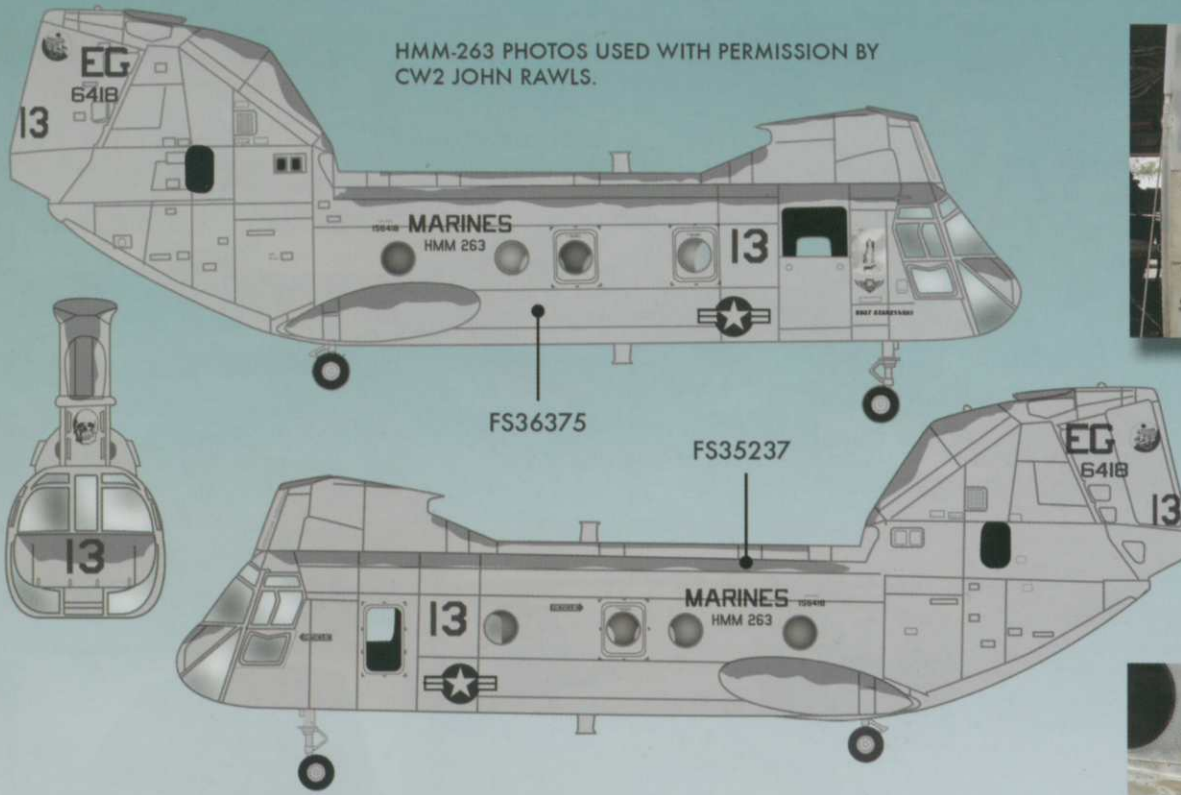

CH-46E HMM-263, "Thunderchickens" photos were taken in Iraq, mid - 2004. They have since stopped flying CH-46s and later this year will be the first unit to take the MV-22B Osprey to combat.

Note: Please use grey data on HC-11 "Gunbearers"

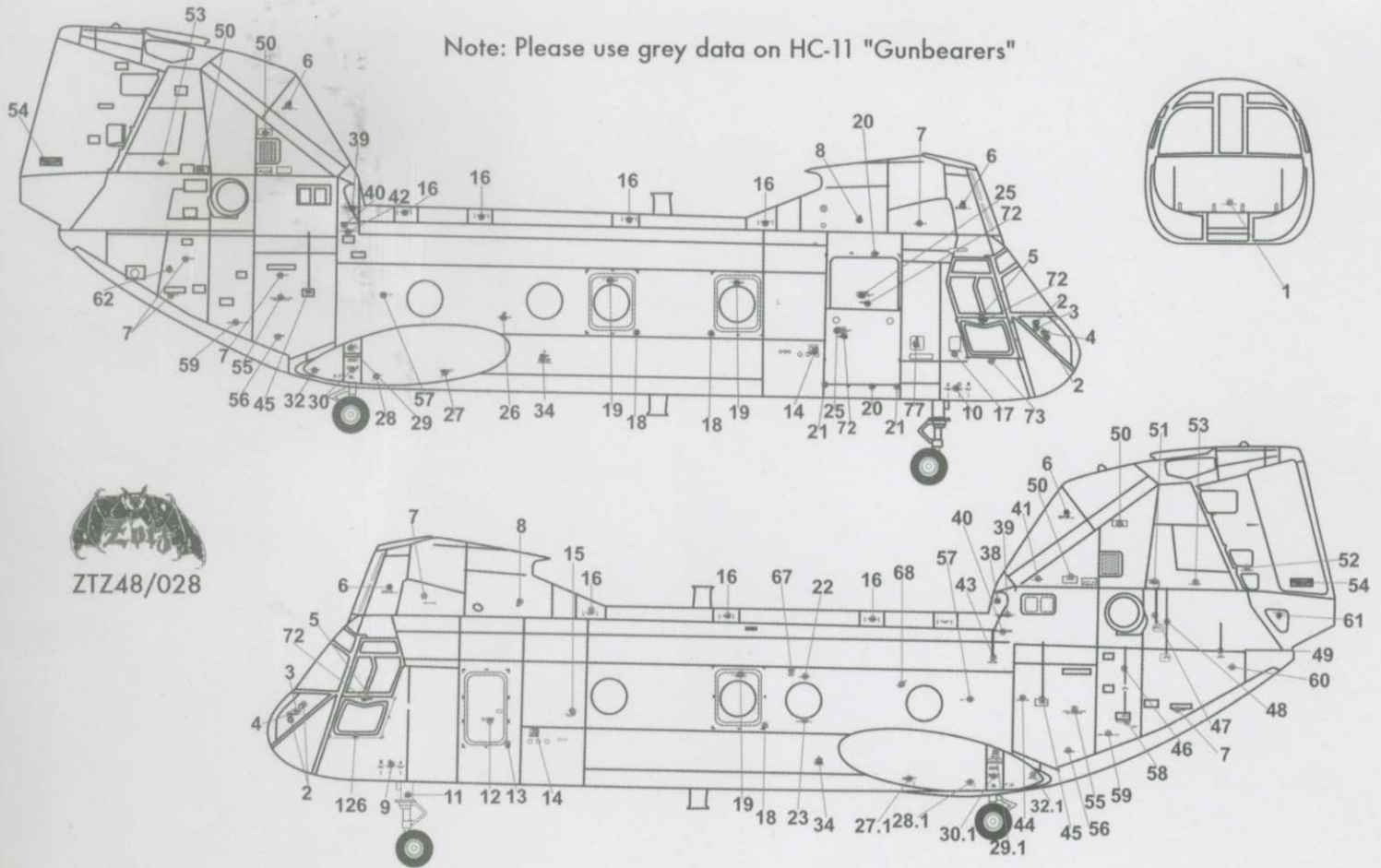

ZTZ48/028



NOTE: GREEN RIMS

