



반대쪽도 조립합니다.
repeat on the opposite side
向こうも同じ方法でつくり直します
対面用一样的方法也重新做



2번 조립합니다.
Make 2 sets.
2組つくってください
同樣制作二組



잘라냅니다.
Remove / Cut
切り取っています
切去



구멍을 만듭니다.
Make hole.
穴あけてください
鑽孔



누릅니다.
Press
押してください
請按



선택 부품입니다.
Optional parts
どちらかを選んでください
可以選擇採用

TS-015
for MENG

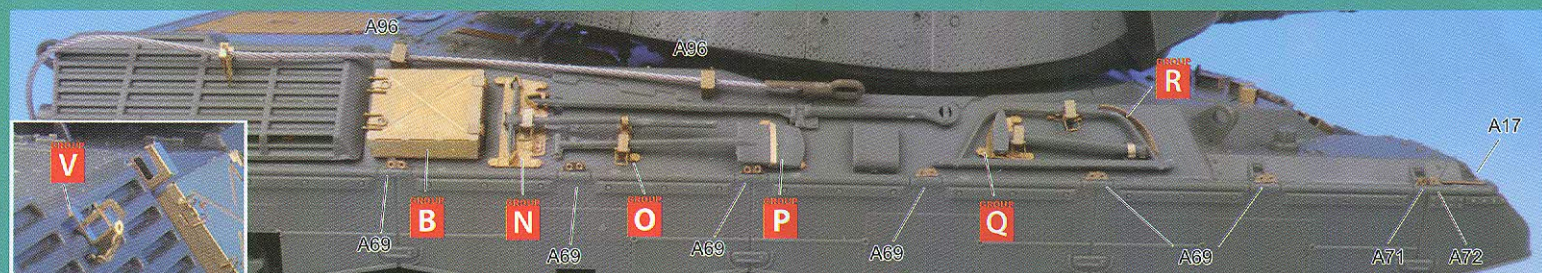
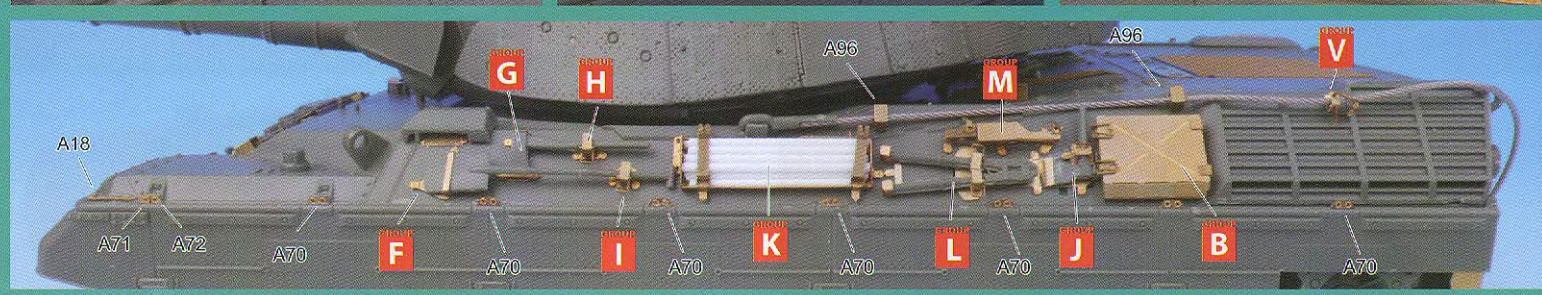
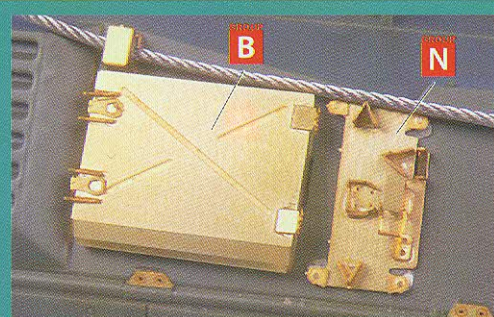
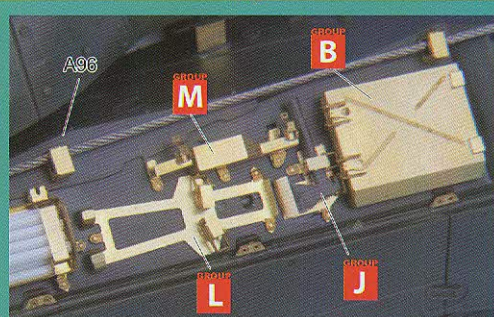
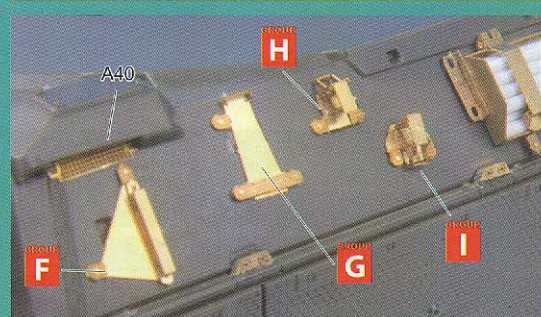
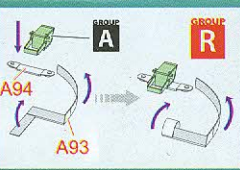
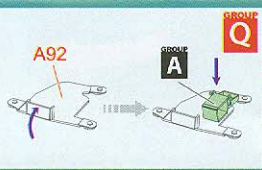
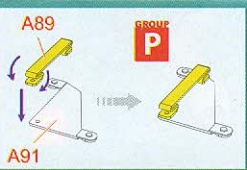
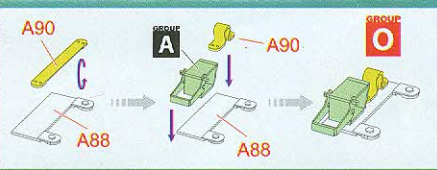
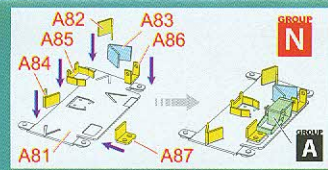
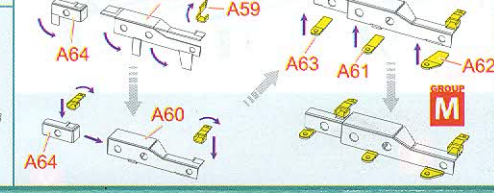
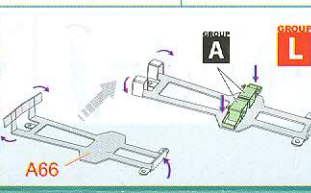
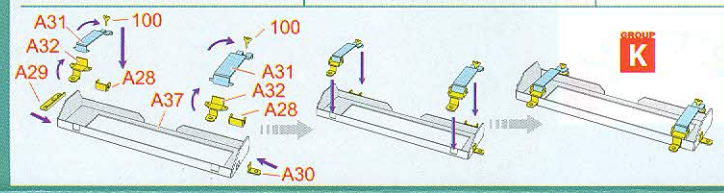
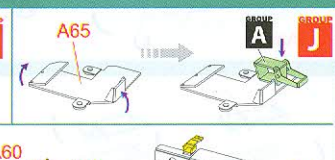
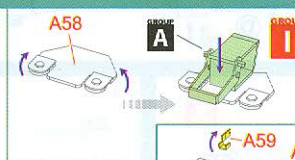
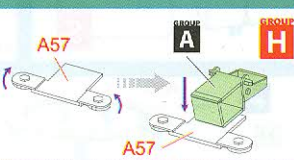
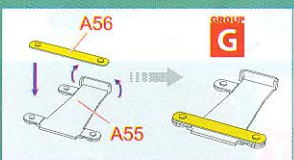
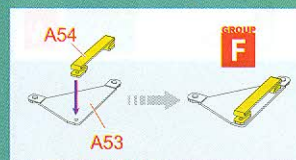
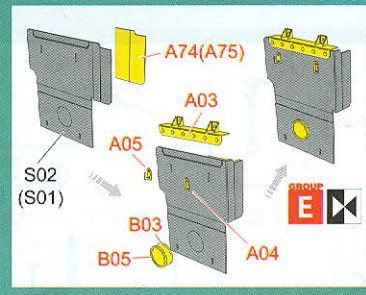
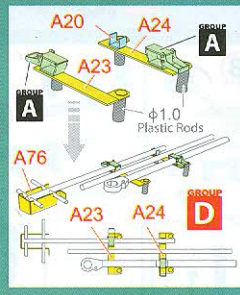
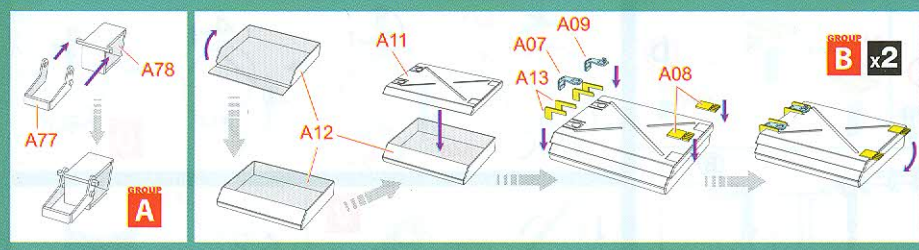
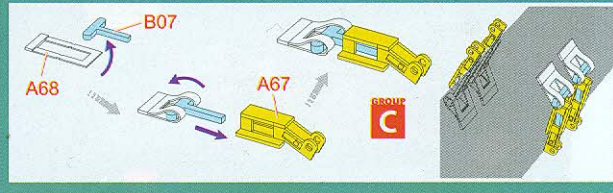
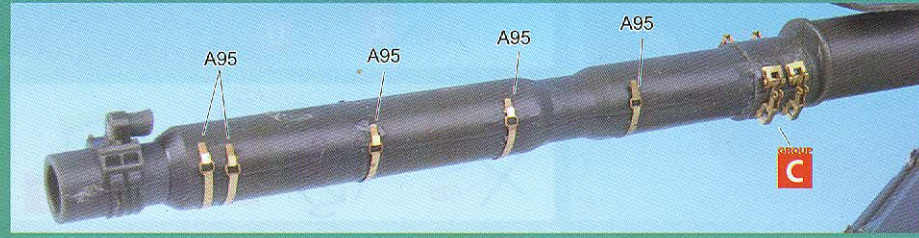

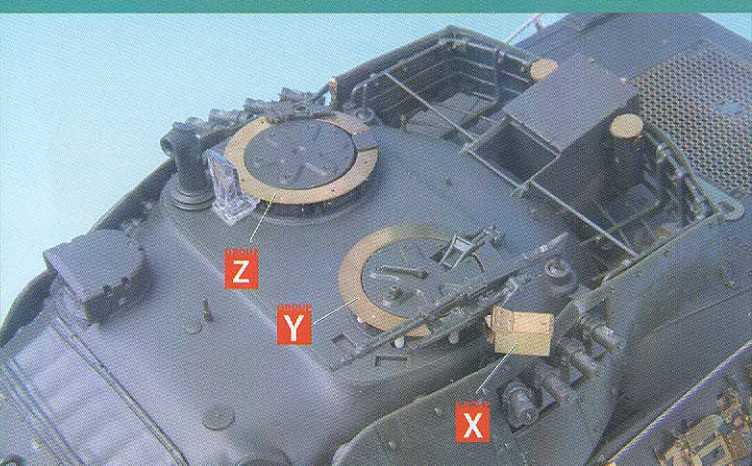
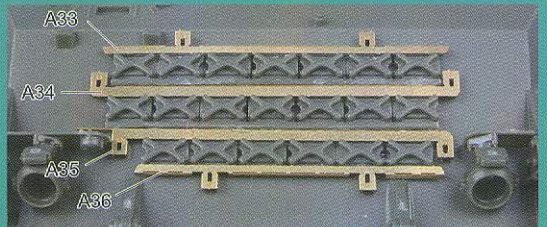
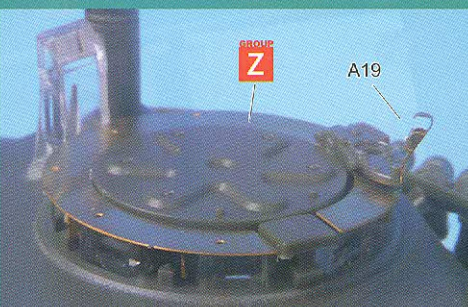
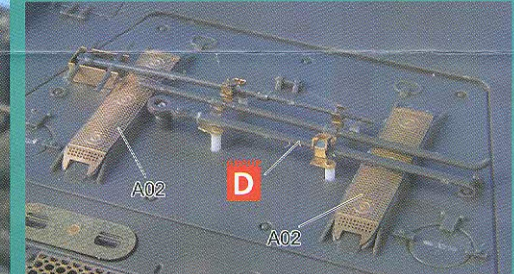
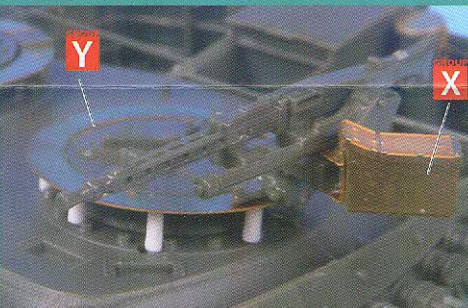
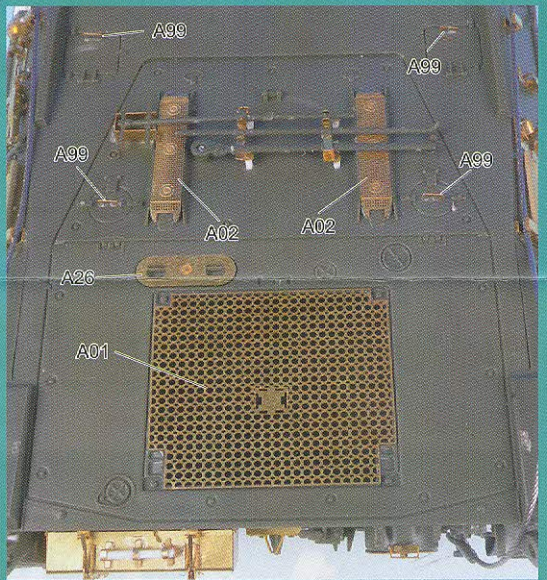
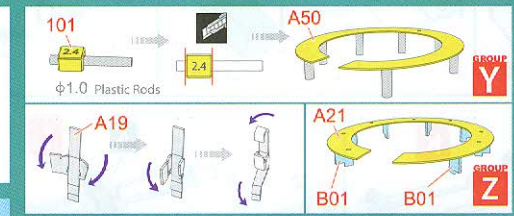
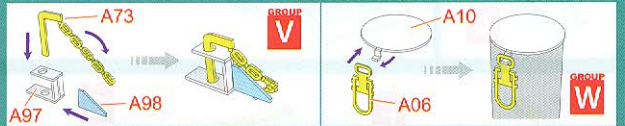
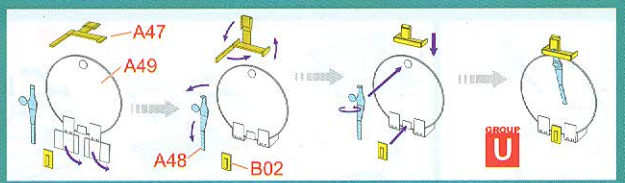
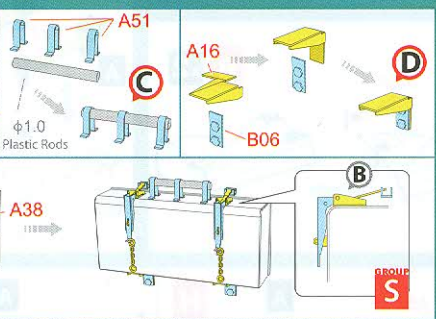
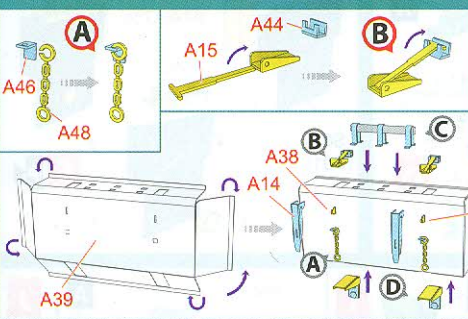
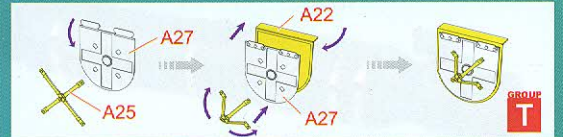
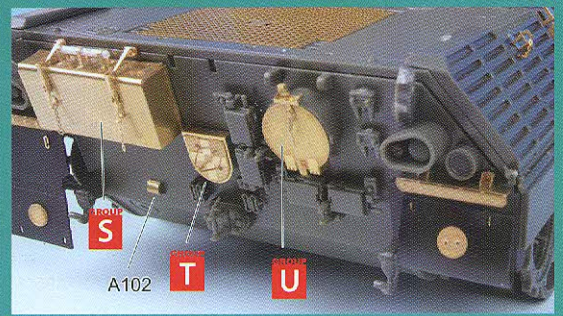
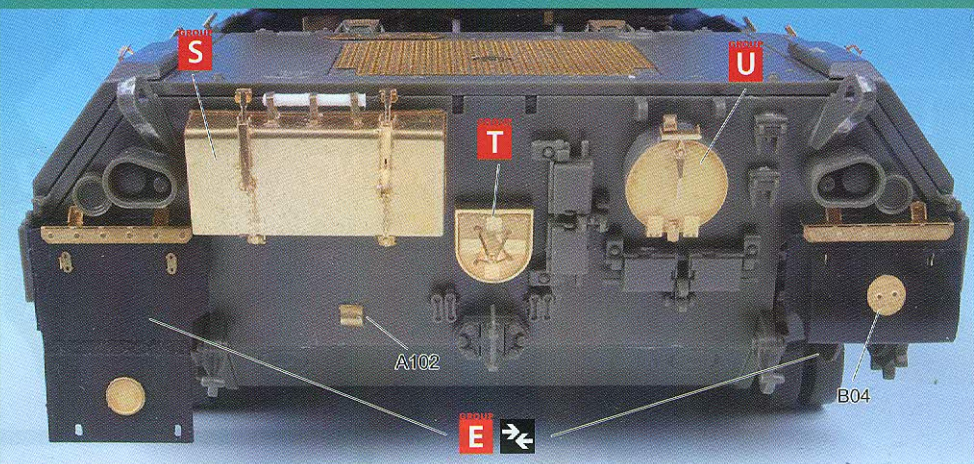

<http://www.facebook.com/tetramodel>