

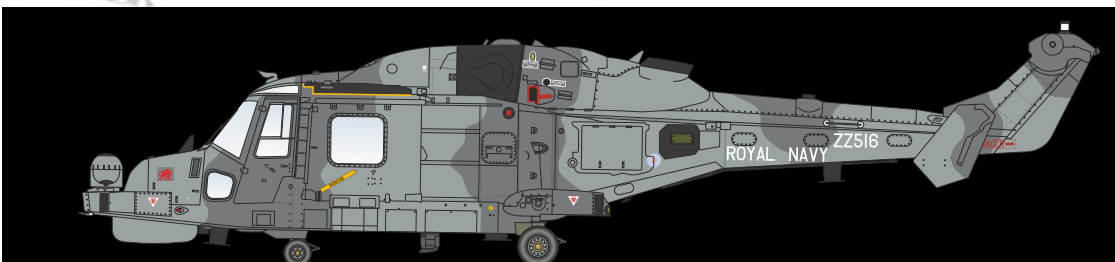

**ON TARGET**  
Conversion Set

**AIR-GRAPHICS**  
**CS-13**



Leonardo  
AW159

# Wildcat

**1:72**  
**Scale**

**HMA 2/AH.1**

**AIR-GRAPHIC MODELS**

# Leonardo AW159 Wildcat Drawings

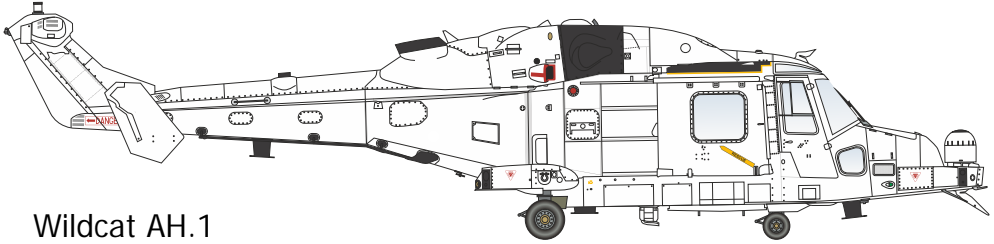
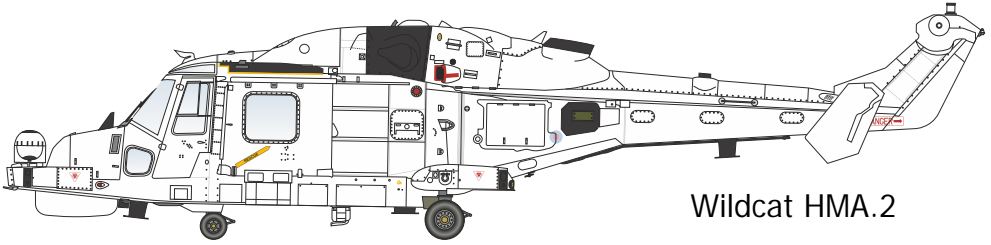

Note\* These instructions generally cover the HMA.2 version

## 1

### Lynx Modifications

 Hobbyboss Kit,  
Parts to be removed

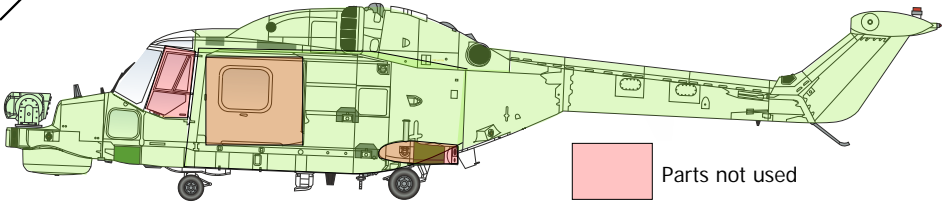

Note, very few of the original Lynx parts are reused apart from the Undercarriage, wheels, windscreen and rotor hub.



# 2

## Cabin Assembly

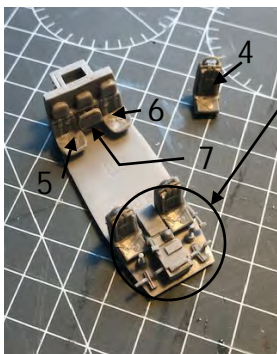
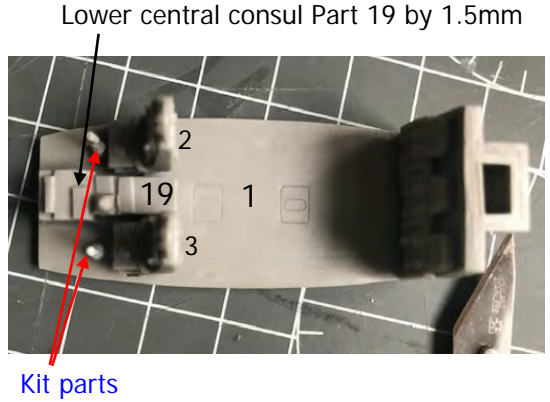
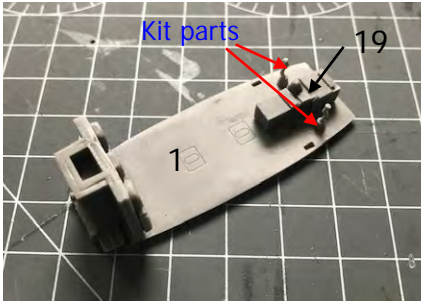

Construction Notes\*  
Do not fit the instrument panel Part 12 at this stage.  
Lower the central consul Part 19 by 1.5mm  
Part 7, central seat needs trimming to fit. Note\* this seat is often folded up.  
I have not painted the interior so that you can see the sequence of construction.

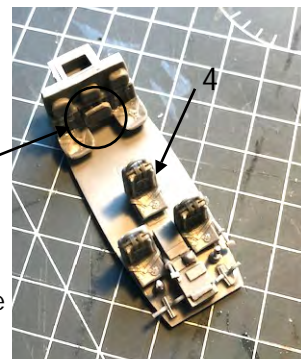

# 3

## Cockpit/Cabin Continued

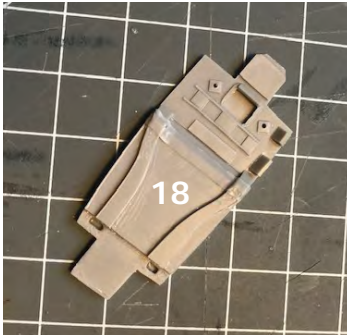

Cabin roof Part 18.  
This is just dry fitted at this Stage to ensure everything fits

# 4

## Cabin walls

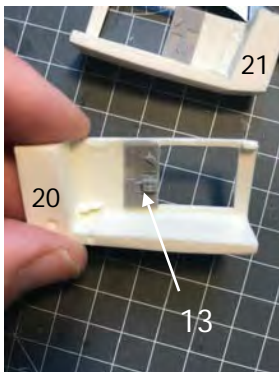
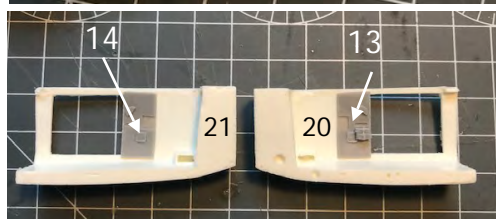
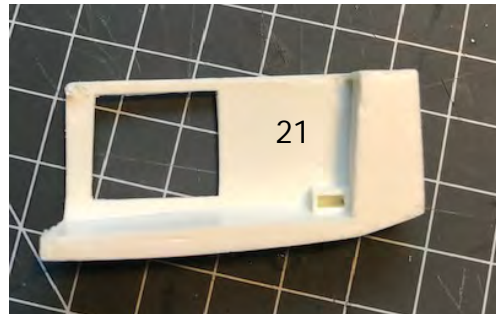

Main cabin construction plus new internal Cabin rear side walls.

Note position of these side walls. Part 13 must go on Part 20. The picture shows the correct colours Etc.



# 5

## Fuselage Assembly



Completed fuselage  
Sides and cabin  
fitted.



Joint lines made  
good with filler.  
I used Squadron Green  
Stuff so it could be  
seen on the photos.

Note nose Part 15 has  
also had any air bubbles  
of moulding lines  
filled and sanded.  
Also, I sanded the  
underside of the nose  
front much flatter.



Nose grafted to fuselage.  
Blend this in with filler.  
The nose glazed windows  
can also be fitted at this  
Stage if required.  
Parts 16 and 17.



# 7

## Tail and Top Deck Assembly



Line Parts 26 and 27 through the Centre line to ensure both are straight

Forward and rear sections matted together and blended in.

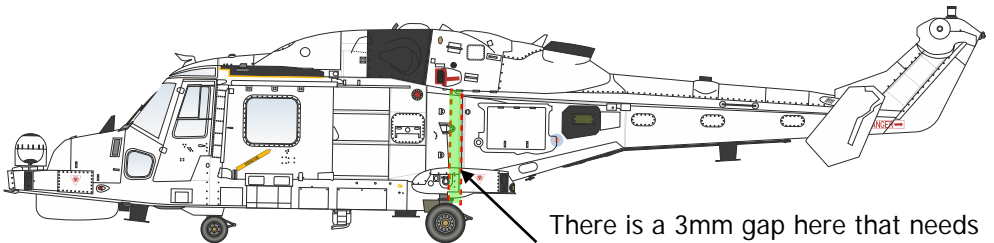
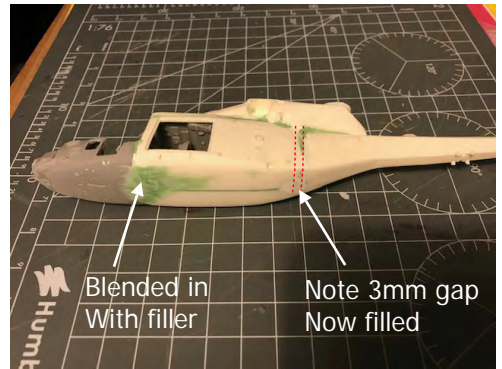

There is a 3mm gap here that needs to be filled. I used plasticard and then finished with filler. This is quick and easy.

# 8

## Tail Assembly

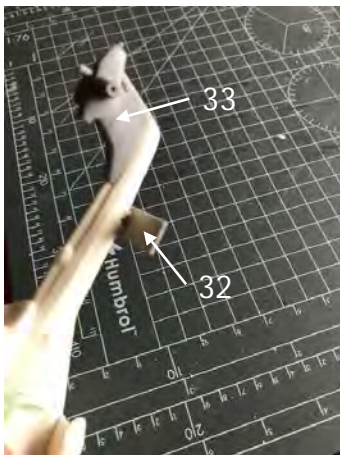

Fit tail Part 33 and blend in with fine filler.

Before fitting Part 32, add a small piece of plasticard to the rear edge as shown in the bottom right picture.

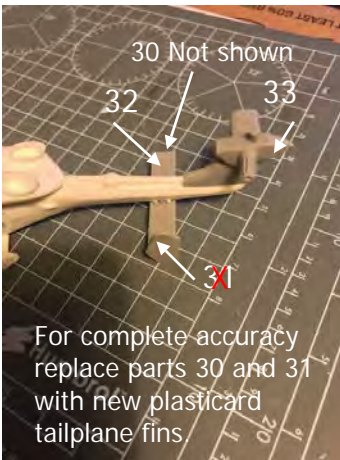

I did not fit the tailplane fins as these were not the right shape. I have drawn these below. make from 1mm plasticard.

For complete accuracy replace parts 30 and 31 with new plasticard tailplane fins

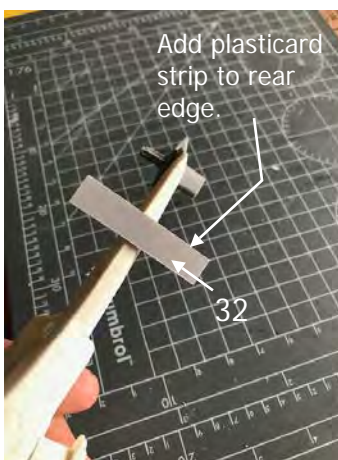

Add plasticard strip to rear edge.

1/72 scale tailplane fins

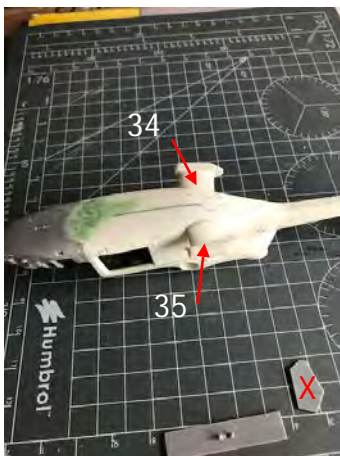
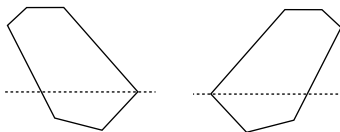

Fit side/wheel Hubs, Part 34 & 35. Take care to get these correctly aligned. I also used a couple of plastic rod guides to help plus make a stronger joint. Blend in With filler.

Add plasticard strip to rear edge.



# 8

## Tail Assembly Continued



Plasticard strip added to rear of tailplane



New plasticard tailplane fins with new plastic channel locating strips



New tailplane fins fitted. This is a very quick modification and makes a big difference.



Detail of rear of tailplane. Note square edge

Shape of tailplane fins

Pictures:  
Gary Madgwick RIAT 2019





# 9

## Underside Detail

Note for AH.1 - Part 26 is not required



Once you are happy with the finish of the underside, start to detail this. Note, Grey parts are resin in general and the White parts are scratch built.



Front undercarriage leg fairing

Note, the harpoon hook is actually in a recessed box which was not realised until later on. I used a small piece of plasticard which will be painted Black to finish.



You will need to drill the holes for the undercarriage legs in the main fairings.

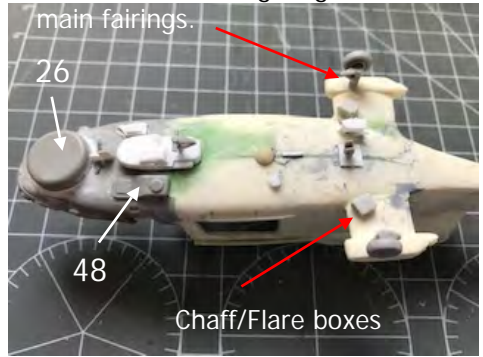

Aerials, and undercarriage fairing made and fitted. Kit parts for the undercarriage legs and wheels.

Harpoon hook from kit.



Chaff/Flare boxes made from from scrap plastic.

Jammer from Air Graphics Chopper set

Note\* Front undercarriage fairing is resin Part 61. There is no harpoon hook and Box. Use Resin Part 51 where harpoon box goes.



# 10

## Fuselage Detail

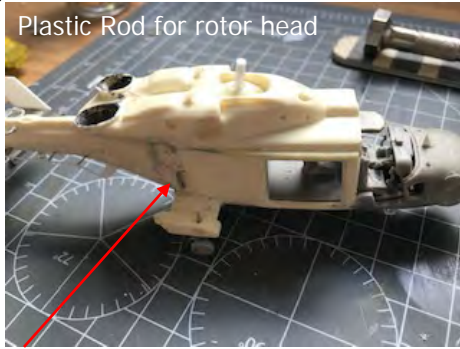

Fit resin Part 54. Not Part 55 is not used On HMA.2 but on opposite side for AH.1 Ensure these fit behind the door when open.

Not plastic rod for rotor hub fitted at this stage. Aerials 58 and 59 fitted.

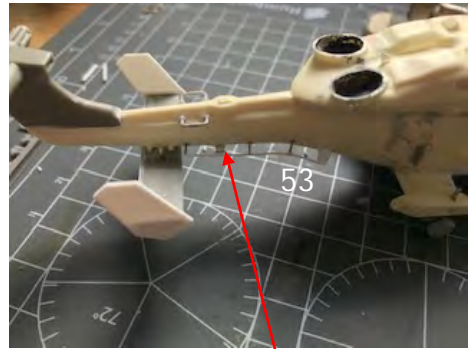
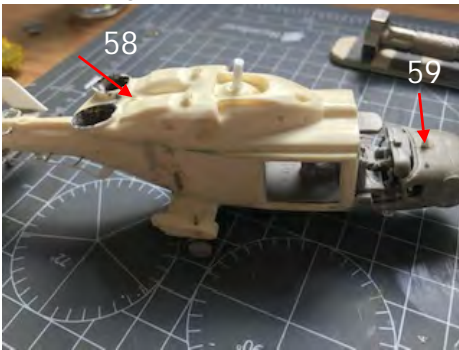

Resin Part 53 can be used but I replaced with plastic rod and card. I also added tail aerials From brass and plastic rod.



Steps either side of rear cabin doors. Note step brackets made from Plasticard and rod. Resin parts Parts 46 and 47 need cleaning up.

Note\* I undercoated the complete model at this stage and cleaned up any joints and resin with a fine white filler.



# 11

## Main Rotor Assembly



Alterations to the rotor head assembly on the kit parts. You will only need the hub on the right hand side. Note\* Hobbyboss have not included the rotor actuator arms which I took from the Airfix Army Lynx kit bits in my spares box.

Ensure hub fits over plastic rod!



Dry assembly of the hub onto the main rotor arm. Note the Green actuator arms from the Airfix kit.

Also Note, the main rotor arms are shown upside down in this picture as I needed to align everything up.

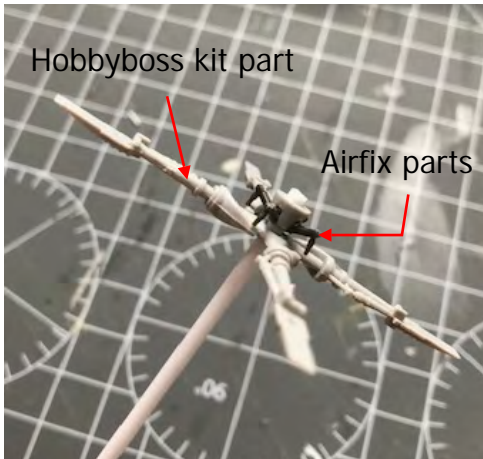

Rotor blades resin Parts 42 - 45 fitted to the rotor arm.

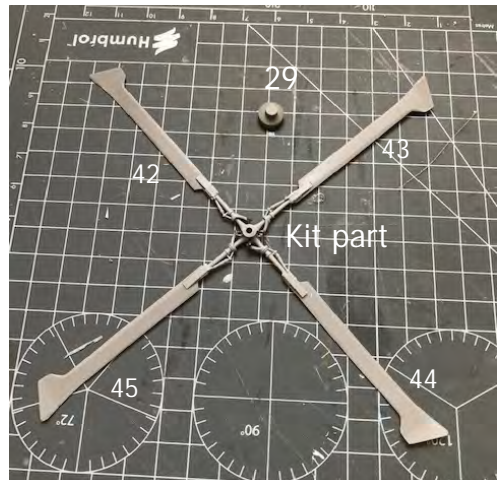

Note\* Part 29 needs to be reduced in height and a hole drilled to take the main rotor rod.

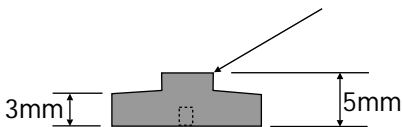



Part 37 is the small tail rotor hub. This needs some small amount of cleaning up.

Part 38 - 41 are the rotor arms. These are fixed to Part 37. Once fitted Part 36 is then fitted over the main tail rotor.



# 13

## Finishing

Scratch built parts

Hook from Revell CH-47 Chinook

Note\* Underside view of completed Wildcat HMA.2

Kit windscreen fitted. Note, this does not fit great so you will need to mask the cabin roof windows and the blend in.

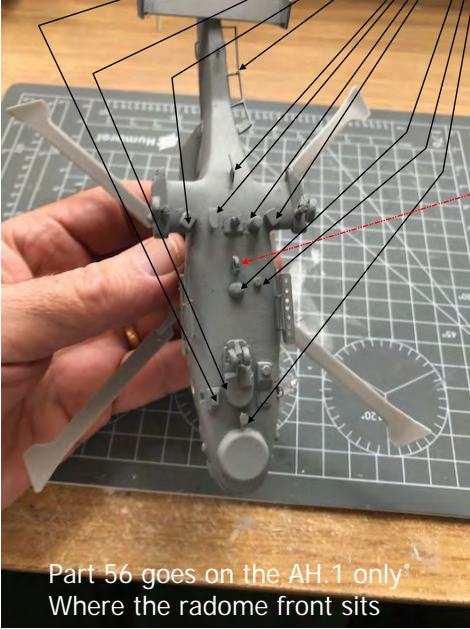

Part 56 goes on the AH.1 only  
Where the radome front sits

Part 49 aerial sits in front  
Of the front undercarriage fairing

Completed rotor head and blades

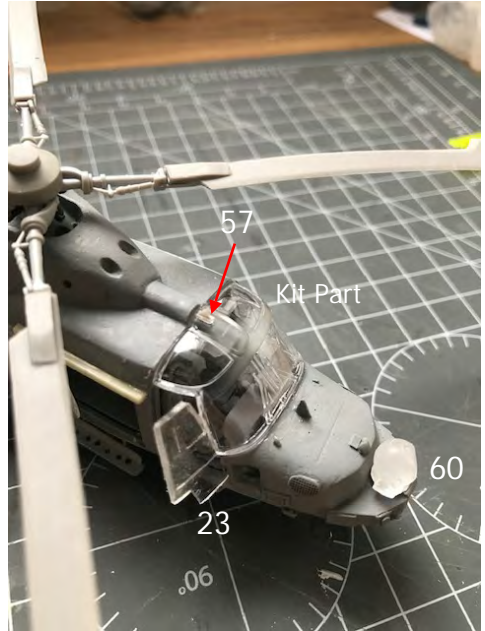

Top door rails fitted either side. Glazed parts  
Also fitted







# AIR-GRAPHICS

Resin Conversion Set

Masters By Colin Pickett  
Casting By Tomas Valch  
Artwork By Jon Freeman

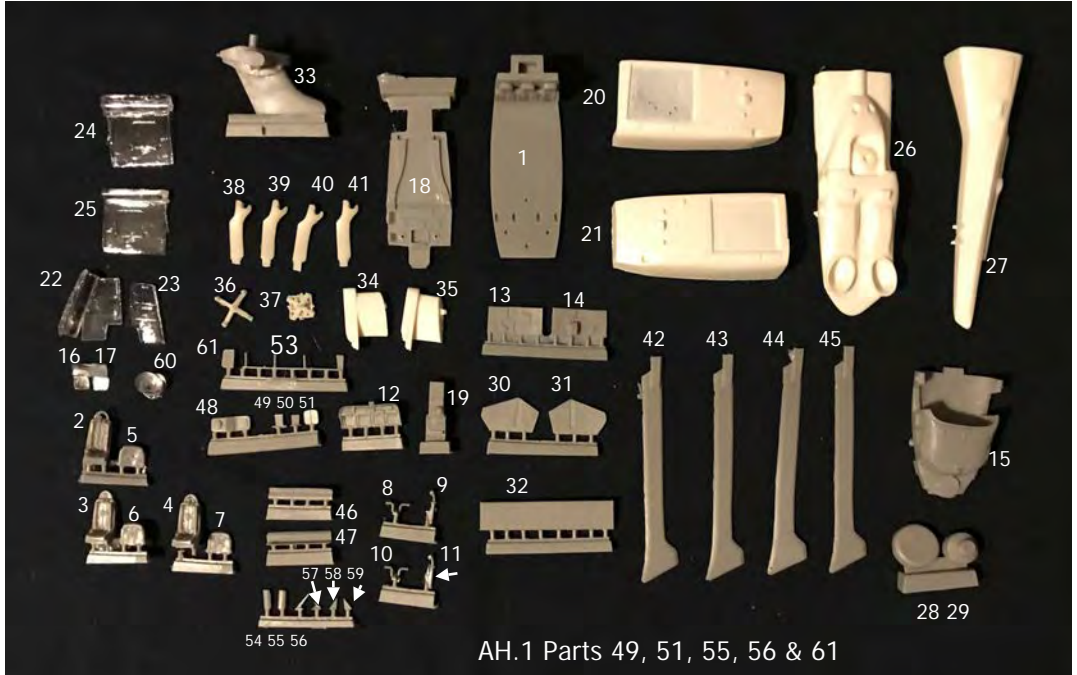

## INSTRUCTIONS

- Remove any flash by gently snapping off, or cutting with a scalpel and then lightly sanding.
- Only use Super-glue or a two-part epoxy glue to fix parts.
- Gluing is easier if mating surfaces are slightly sanded to roughen the resin before gluing. Also clean off any dust before gluing.
- Before painting, thoroughly wash all parts in warm water with detergent.
- We recommend the application of a base coat in a light colour to show any blemishes prior to final painting.

## WARNING & SAFETY!

- These parts are moulded in polyurethane resin. Please take care when sanding and cleaning up the resin by wearing a dusk mask or other protective breathing device to avoid inhalation of the dust particles.
- Wash hands, resin parts and the work surface after sanding resin.
- When using Super-glue or two-part epoxy glue, please take precautions to avoid contact with skin and eyes.
- It is also advisable to wear a mask to avoid breathing in any fumes from the glue or work in a ventilated room.
- The use of barrier creams on hands or wearing disposable gloves, and working in a well ventilated area, is strongly recommended.
- Not suitable to children under 14 years of age.

Thank you for purchasing this Air-Graphics product which forms part of a range of accessories, conversion sets, decals & kits all to 1/72 Scale.

Air-Graphics: 24 Fyfield Close, Wantage, Oxfordshire, OX12 8HN, UK.  
E: gary.madgwick@air-graphics.co.uk