

648 634 B-17F guns

for HKM kit - pro stavebnici HKM

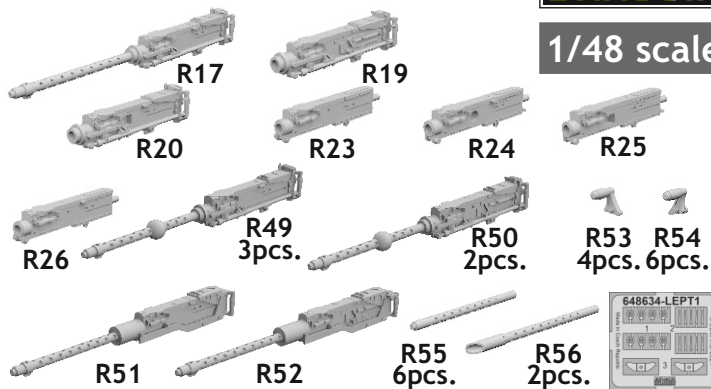

1/48 scale



COLOURS

GSI Creos (GUNZE)			Mr.METAL COLOR	
AQUEOUS	Mr.COLOR			
[H 2]	[C 2]	BLACK		
[H 8]	[C 8]	SILVER		
[H 12]	[C33]	FLAT BLACK		
[H 37]	[C 43]	WOOD BROWN		
	[C 92]	SEMI GLOSS BLACK		

This product contains metal and resin detail parts for upgrading scale plastic models. When selecting this set make sure that it is for the kit mentioned in product name as these sets are made specifically for that kit. When upgrading the model some cutting or corrections may be necessary for parts to fit accurately. **WARNING!** This set contains small and sharp parts. Work carefully in a ventilated and well-lit room. Safety glasses are recommended. This product is not suitable for children below 14 years of age.

Tento výrobek obsahuje leptané a odlévané detaily pro úpravu a vylepšení plastického modelu. Při výběru sady kovových detailů zkontrolujte, zda je určena pro model, který chcete upravit. Model, pro který je sada určena, je uveden u názvu výrobku. Pro přesnou aplikaci kovových a odlévaných dílů může být zapotřebí upravit díly upravovaného modelu. **POZOR!** Sada obsahuje malé ostré díly. Pracujte ve větrané a dobře osvětlené místnosti. Doporučujeme použití ochranných brýlí. Tento výrobek není vhodný pro děti mladší 14 let.

435 21 Obrnice 170
Czech Republic

www.eduard.com
24,95



648 634 B-17F guns

for HKM kit - pro stavebnici HKM

1/48

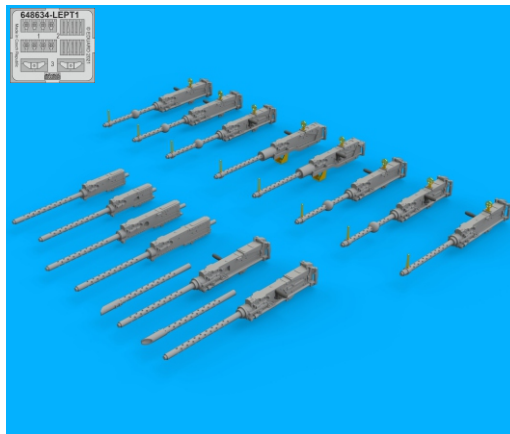
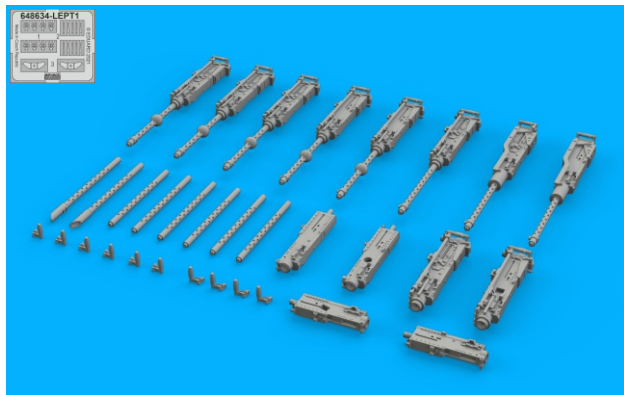
BEST BRASS RESIN AROUND!

WAIST WINDOW GUN ASSEMBLY

A RIGHT SIDE



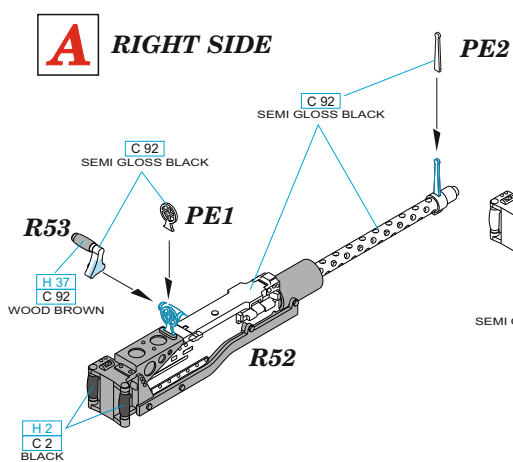

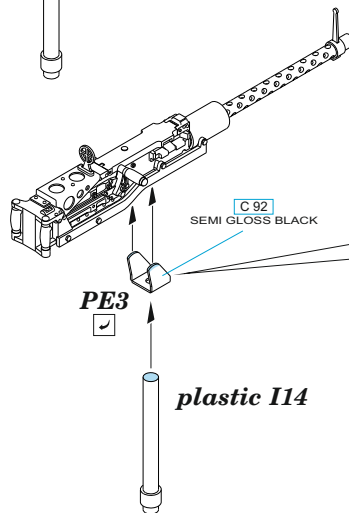
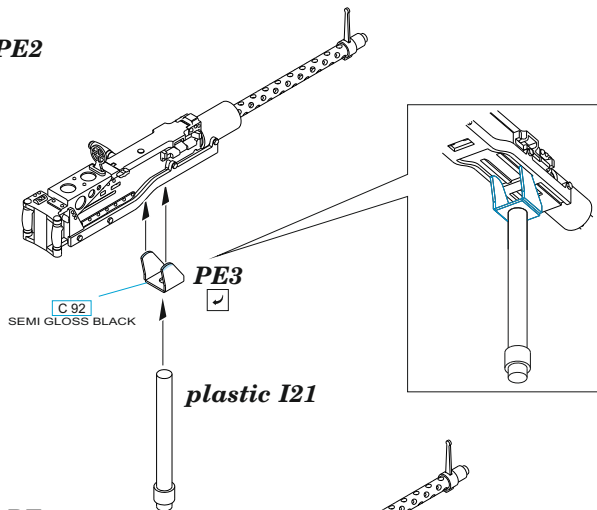
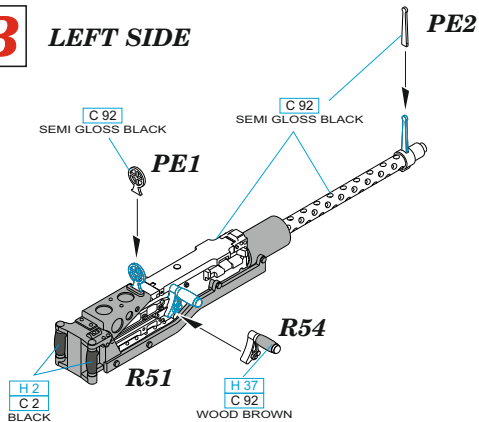
B LEFT SIDE

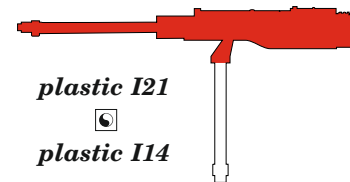

 =



- REMOVE ODSTRANIT
- BEND OHNOUT
- GRIND OBROUSIT
- OPTION VOLBA
- DRILL HOLE VRTAT OTVOR
- REPLACE NAHRADIT
- SYMMETRICAL ASSEMBLY SYMETRICKA MONTAZ
- SCRIBE THE PANEL AND HOLES RYTI
- REVERSE SIDE OTOCIT

 =  $\varnothing - 1,3mm$

RADIO COMPARTMENT GUN ASSEMBLY

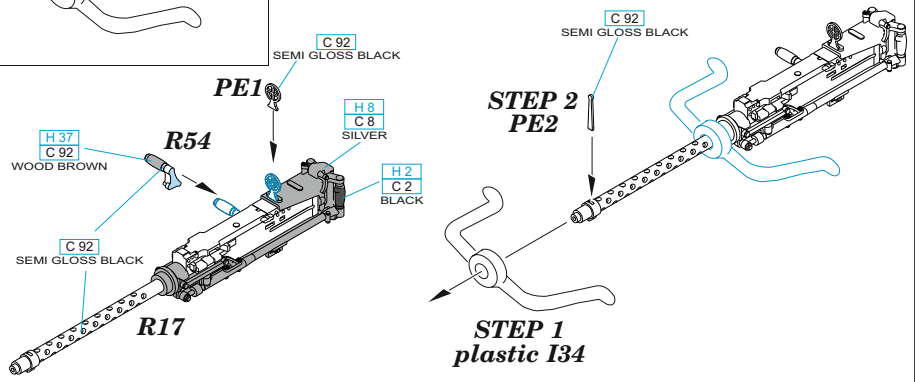
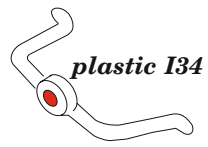

BALL TURRET GUNS ASSEMBLY

plastic V2+V17  *plastic V1+V18*

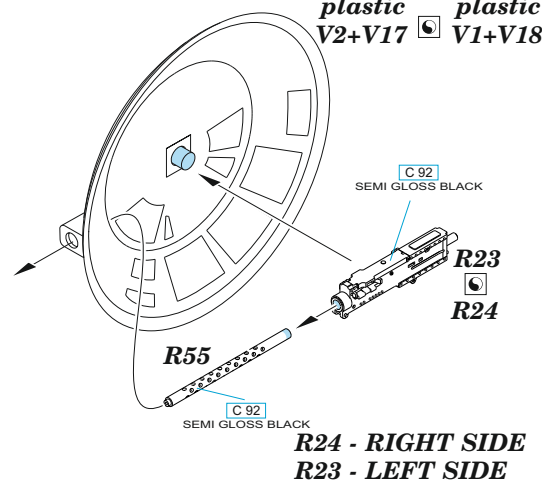

CHEYENNE TAIL TURRET GUNS ASSEMBLY

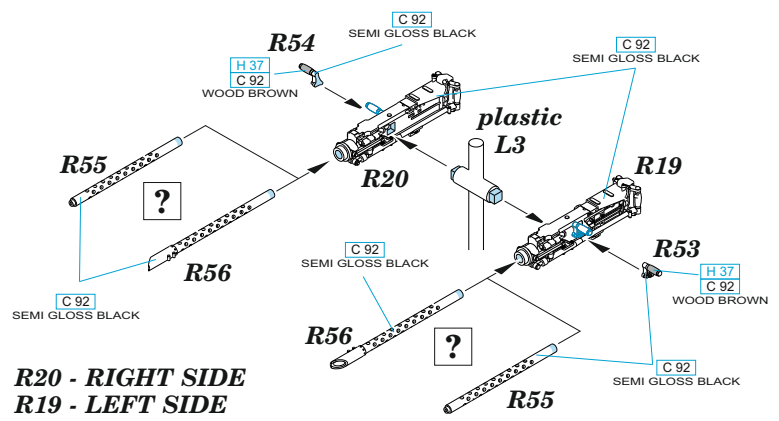

TOP TURRET GUNS ASSEMBLY

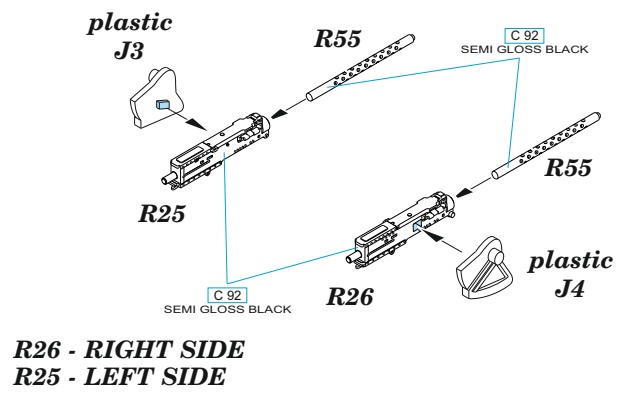

CHEEK GUN ASSEMBLY

C

LEFT SIDE

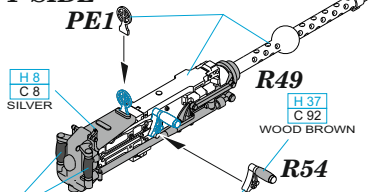

H 2
C 2
BLACK

C 92
SEMI GLOSS BLACK

STEP 2
PE2

STEP 1
plastic P1

D

RIGHT SIDE

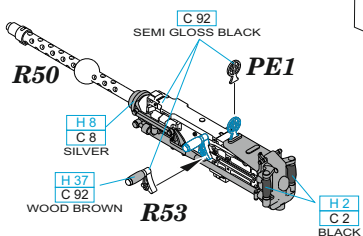

C 92
SEMI GLOSS BLACK

STEP 2
PE2

C 92
SEMI GLOSS BLACK

STEP 1
plastic P2

 =  $\varnothing - 1,3mm$

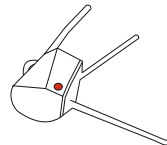

NOSE GUNS

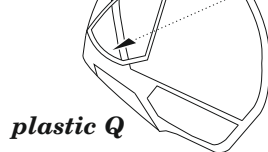

STEP 1
plastic P7

plastic Q



STEP 2
PE2

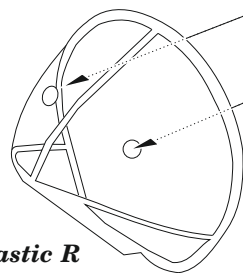

STEP 1
plastic P8

plastic R

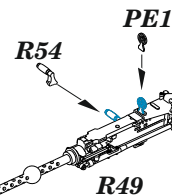

R49

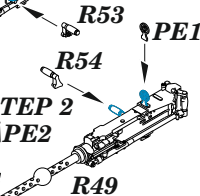

R49