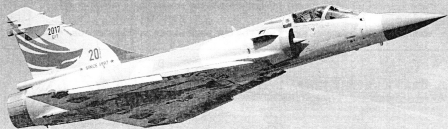

軍事連線
Military Connection

塗裝貼紙繪製：吳宏信
 塗裝貼紙考證協力：李人岳、管廷境、李鴻輝、謝文瑞
 塗裝貼紙版面編排：劉學謙
 產品企劃協力：軍事連線

本產品經著作權人授權由天力模型有限公司並交由KINETIC天力模型生產

ROCAF MIRAGE 2000-5DI/SEI

The Mirage 2000-5 is the latest variant of the French delta-wing Mirage 2000 fighters. It was an extensive upgrade based on the Mirage 2000C in order to boost export sales and keep the ageing Mirage on par with the F-16. The effort was proven a success when the first order was received from Taiwan in 1992, only one year after the aircraft's initial flight in April 1991. This also marks the first ROCAF (Republic of China Air Force) purchase of French fighters since 1937.

The Taiwanese Air Force purchased 60 Mirage 2000-5s in total, of which 12 were the Mirage 2000-5Di (double seat). The procurement also included DEFA 554 cannons since the double-seaters were not internally mounted with 30mm guns as in the single-seat version. The ROCAF Mirage 2000-5s are operated by the 499th Tactical Fighter Wing at Hsinchu, and entered operational service in 1997 when the first squadron, 41st TFS (later TFG) commissioned.

The paint scheme features a stylised dragon on the tail as well as P-47D, F-86, F-100 and F-104 designs on the underside of the aircraft – all types that the 499 TFW has operated during its 64 years of history.

中華民國空軍幻象2000-5單/雙座戰鬥機 服役20週年紀念塗裝

幻象2000-5為法國三角翼幻象2000戰鬥機的衍生型，是以2000C型為藍本大幅改造而成，為刺激出口市場及針對美製F-15所研發。台灣空軍在1993年執行「飛龍計劃」的第二代戰機採購案，總共向法國購買達索飛機公司生產的幻象2000-5戰鬥機60架，其中包括單座機48架和雙座機12架。幻象2000-5戰鬥機主要負責台灣北部空防的高空攔截任務。國軍的幻象2000-5戰鬥機均配屬新竹空軍基地的499聯隊，並於1997年第一支幻象2000-5戰機中隊【第41中隊】編成的同年開始投入服務。

「慶祝幻象戰機服役20週年」的紀念彩繪，垂直圖案以「龍」與「鳳」元素構成，而在機體的彩繪設計，則是以空軍499聯隊64年間所使用的各機型，包括P-47D、F-86、F-100、F-104等飛機圖稿組成。

WARNING: CONTAIN SMALL PARTS NOT FOR CHILDREN UNDER 14 YEARS OF AGE.

Drill



Remove



2 Set



Bend



Optional



Decal



Super Glue



Fill Hole



No Cement



Be Careful

TOOLS RECOMMENDED

Cement



Side Cutter



Modeling Knife



Tweezers

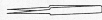

CAUTION 

*Read carefully and fully understand the instructions before commencing assembly.

*Keep out of reach of children. Children must not be allowed to put any parts in their mouths, or pull plastic bag over their heads.

*When using adhesives and paints, please make sure not to use them in closed room or near the fire.

*When assembling this kit, tools including knives are used. Extra care should be taken to avoid injury.

WARNING: CONTAIN SMALL PARTS NOT FOR CHILDREN UNDER 14 YEARS OF AGE.

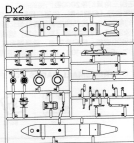
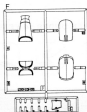
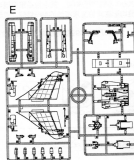
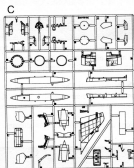
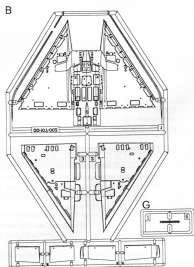
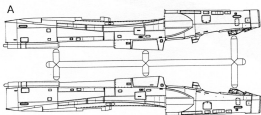

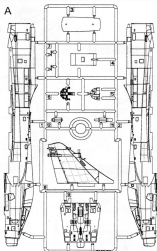

Ox2

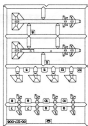

Qx2

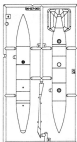

AFTERMARKET SERVICES CARD

When requesting replacement parts, please take or send this form to your local dealer so that the parts required can be correctly identified. Please note that specifications and availability are subject to change without notice.

For more information, please contact services@kineticmodel.com or visit <http://www.kineticmodel.com> for latest information.

F



Mx2

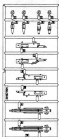

PAINT INDEX

COLOR	AMMO MIG	VALLEJO MODEL COLOR	GSI CREOS MR.COLOR	TAMIYA ENAMEL/ACRYLIC	HUMBROL ENAMEL
GLOSS BLACK	046	70 891	2	X-1	21
BURNT IRON	187	—	61	XF-71+XF-56-5	53
STEEL	191	71 095	29	XF-84	53
GRAY FS36375	203	—	308	XF-19	127
GRAY FS36320	208	—	307	XF-23+XF-66-1	128
LIGHT GRAY	209	71 276	11	—	147
BLUE GRAY AMT-11	210	71 304	337	—	145
OLIVE DRAB	237	70 899	12	XF-62	66(155)
MEDIUM SEA GRAY	246	71 307	335	XF-83	—

For Color Profile, please go to www.kineticmodel.com for download (type the kit# and go for manual/painting guide)

1-1

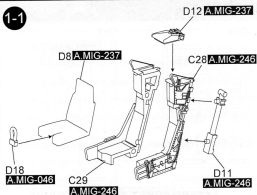

1-2

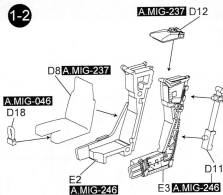

2-1

MIRAGE 2000-5Ei

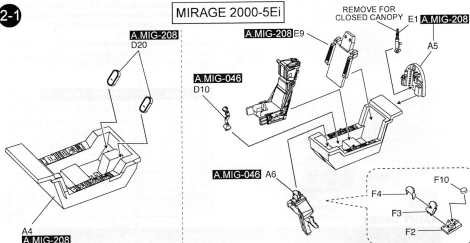

2-2

MIRAGE 2000D-5i

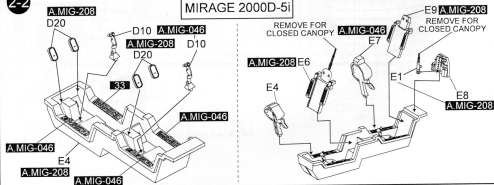

3-1

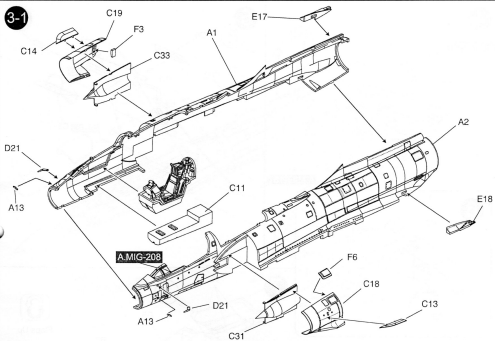

3-2

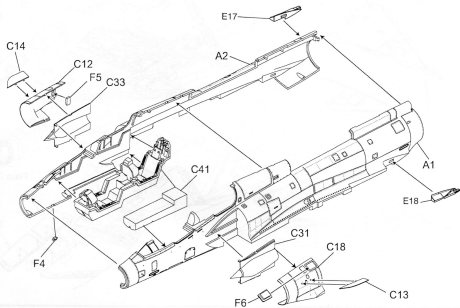

4

A.MIG-187

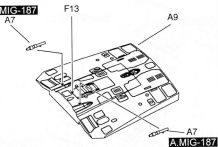

5

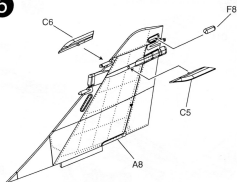

6

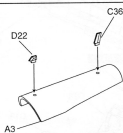

7



Flaps Up

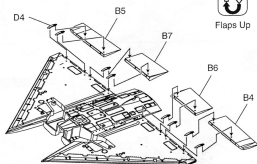

Flaps Down

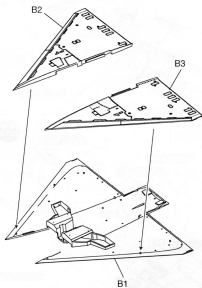
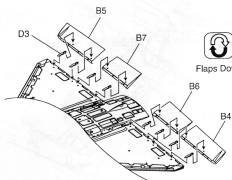

8-1

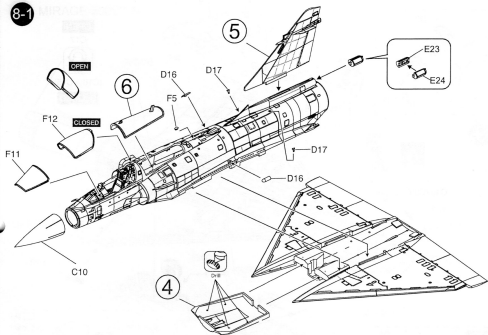

8-2

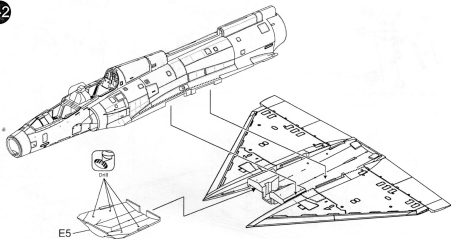

10 MIRAGE 2000D-5i

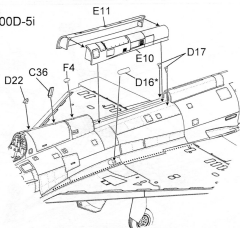

*OPPOSITE SIDE

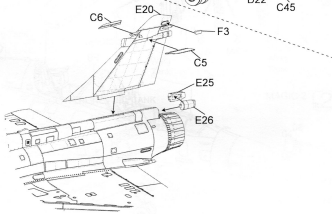
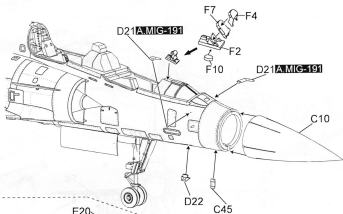

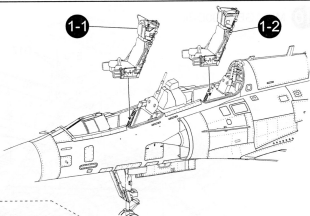
11**1-1****1-2**

CANOPY CLOSED

F8 F10

F11

F9

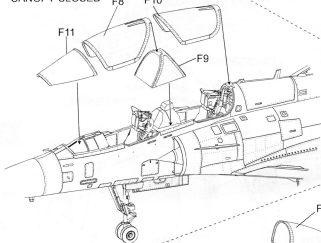

CANOPY OPEN

F8

F10

F11

F9

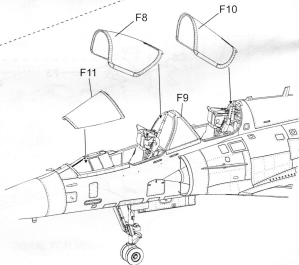

12

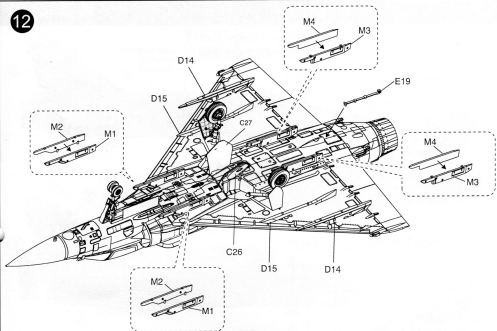

13

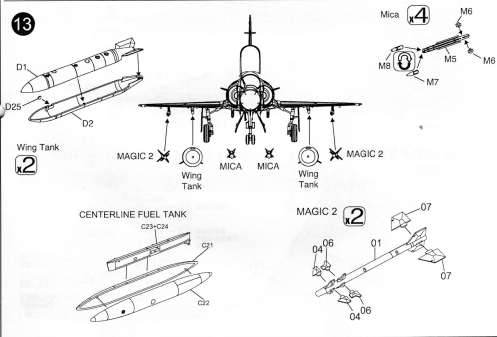

ROCAF Mirage 2000-5

接機20週年紀念塗裝

A.MIG-210(30%)
+208(60%)
+203(10%)

Mirage 2000-5 雙座機 "2055 / DI05"

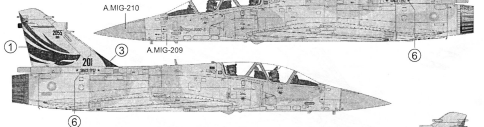

Mirage 2000-5 單座機 "2017 / EI17"



-  A.MIG-210
-  A.MIG-209
-  A.MIG-210(30%)
+208(60%)
+203(10%)

機號	2003	2017	2020	2055	2056
空尾架繪	●	●	●	●	●
機翼彩繪					
	單座	單座	單座	雙座	雙座

2003/2017/2055 三架機標2018年陸續由空軍空運進台，
係空2422中隊之SOLO DEMO機，另增加2056空軍空軍標機。

Mirage 2000-5 單座機
"2017 / EI17"

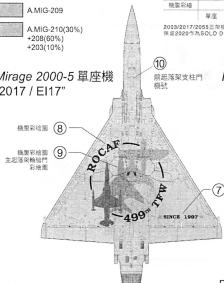

Mirage 2000-5 單座機
"2020 / DI20"

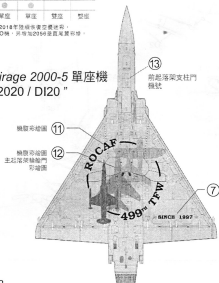

ROCAF *Mirage 2000-5*

ETT換訓中隊/法國蒙德馬松

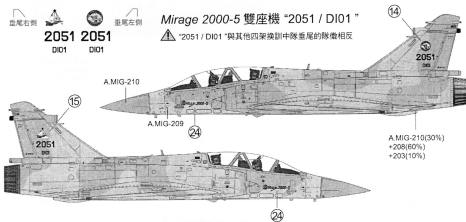

- A.MIG-210
- A.MIG-209
- A.MIG-210(30%)
+208(60%)
+203(10%)

垂直右側



2052
DI02



垂直左側

2052
DI02

Mirage 2000-5 雙座機 "2052 / DI02"

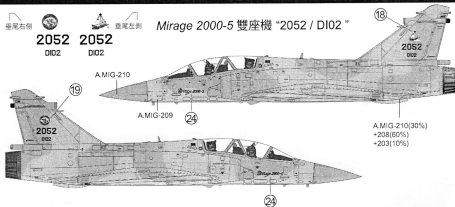

垂直右側



2053
DI03



垂直左側

2053
DI03

Mirage 2000-5 雙座機 "2053 / DI03"



垂直右側



2054
DI04



垂直左側

2054
DI04

Mirage 2000-5 雙座機 "2054 / DI04"

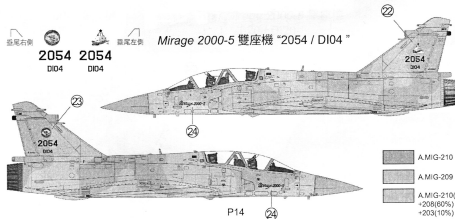

-  A.MIG-210
-  A.MIG-209
-  A.MIG-210(30%)
+208(60%)
+203(10%)