



WWII Diesel Engine MAN M9V46

MAN-9-Zylinder-Viertakt-Diesel 46

Diesellový motor MAN M9V46



N72027

Highly detailed upgrade set
Hochdetailliertes Upgrade-Set
Detailní doplňková sada



For Kit:
U-BOOT typ IXC
Revell 1/72

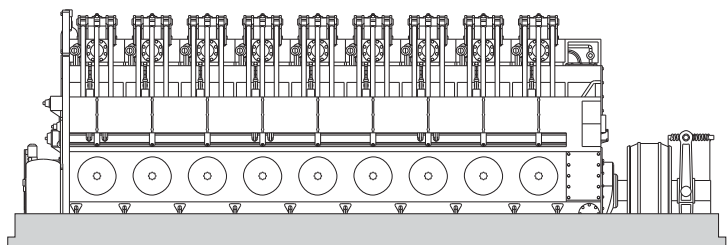

1

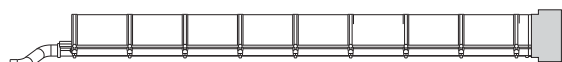

14

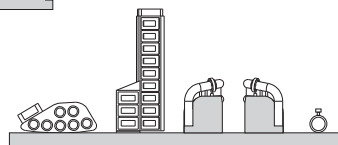

3 4 6 7 2

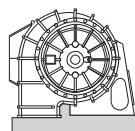

8

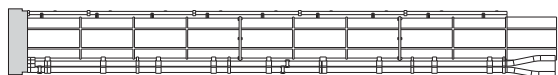

12

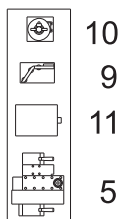

10

9

11

5

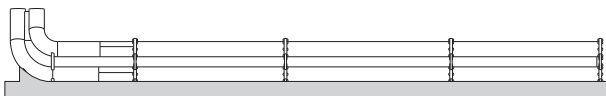

13

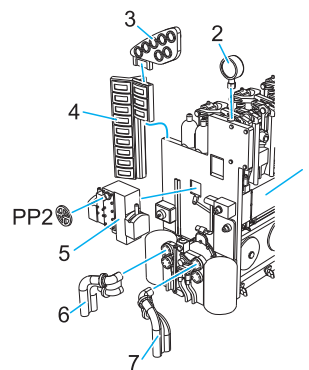

1

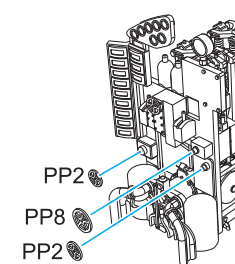

PP2

PP8

PP2

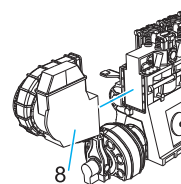

2

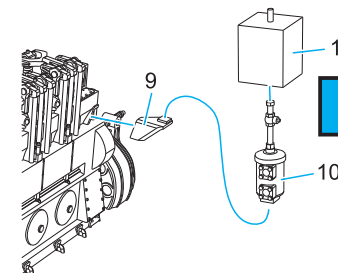

11

4

10

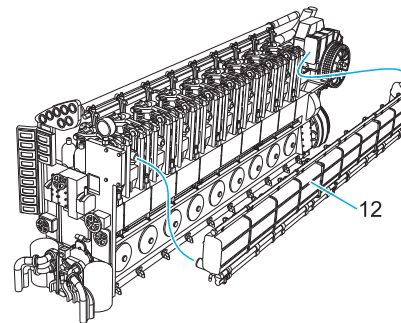

3

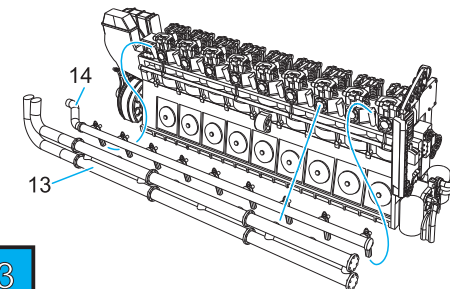

14

13

12

Wires and plastic profiles
are not included in the set

Dräht und Plastikprofile sind
nicht Bestandteil dieses
Upgrade-Sets

Dráty a plastikové profily
nejsou součástí stavebnice

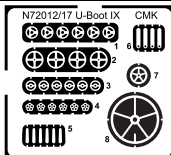

CMK Micro Saw
Mikrosäge

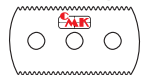

MPM Production Ltd.
Mezilesí 718, Praha 9, 193 00 CZECH REPUBLIC
www.cmkkits.com / www.specialhobby.eu
e-mail: office@specialhobby.eu



Final assembly - rear view
Fertige Montage - Kontrollansicht
Dokončení montáže - pohled zezadu

