



EASY ASSEMBLY AUTHENTIC KIT



cyanoacrylate glue
强力胶



weight
配重



make hole
钻孔



cut / remove
切除



option
选择



no cement
不涂胶水



decal
贴纸



bend
弯曲

The way to apply the decals

1. Cut off the decal from the decal paper and put it into the warm water 40° for 10 seconds.
2. Take the decal from the water and put it on a piece of clean cloth.
3. Remove the decal slowly from the paper to the targeted location by a wet finger.
4. Use a piece of dry and soft cloth to press it gently on the decal until it getting dry and no bubble existing.

水贴纸的使用方法:

- 一、把相关的印花从水贴纸上下下，放入40℃左右的温水中浸10秒。
- 二、然后将印花放在干净的布上。
- 三、拿上印花纸胶，手指蘸水将印花移动到适当的位置。
- 四、用软干布轻轻印花直至水干，气泡消失。

VC-33, U.S.N

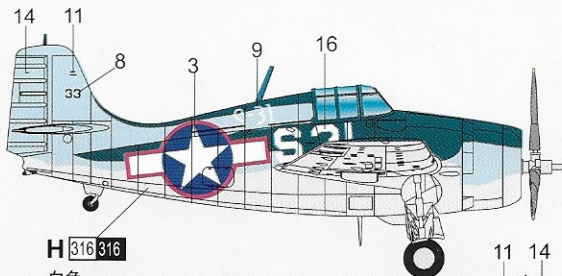

H 316 316

白色
White Insignia

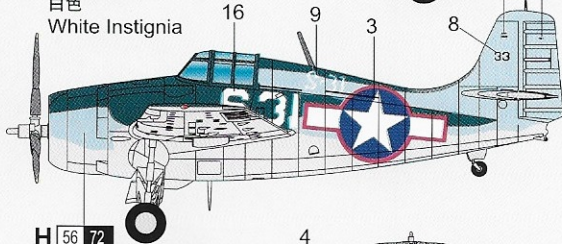

H 56 72

灰蓝色
Intermediate Blue

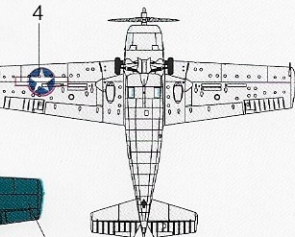
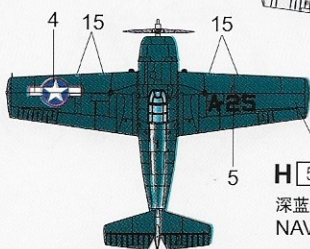

H 5 14

深蓝色
NAVY Blue

VC-12, U.S.N

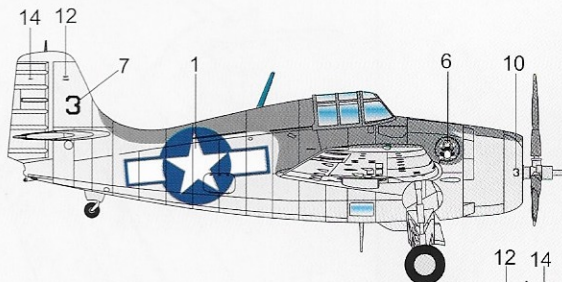

H 316 316

白色
White Insignia

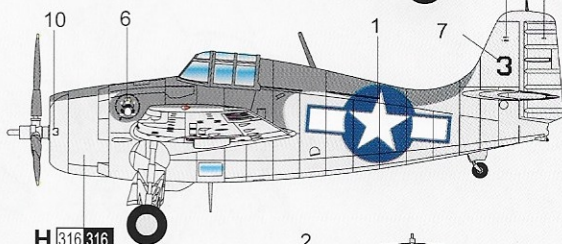

H 316 316

白色
White Insignia

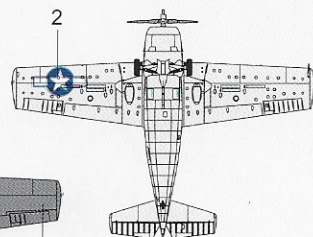
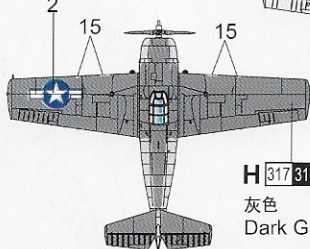

H 317 317

灰色
Dark Gull Grey

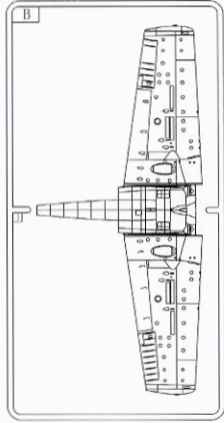
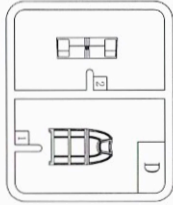
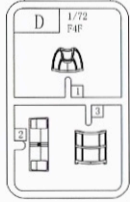
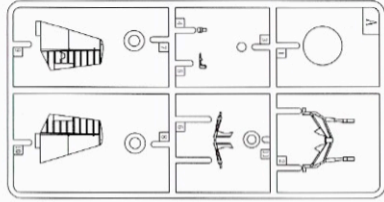

1

?
可选择
Option



D3

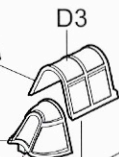

A9



机身
Fuselage

D1



A3



A1



A4



A10

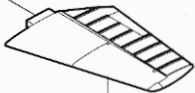

机翼
Wing

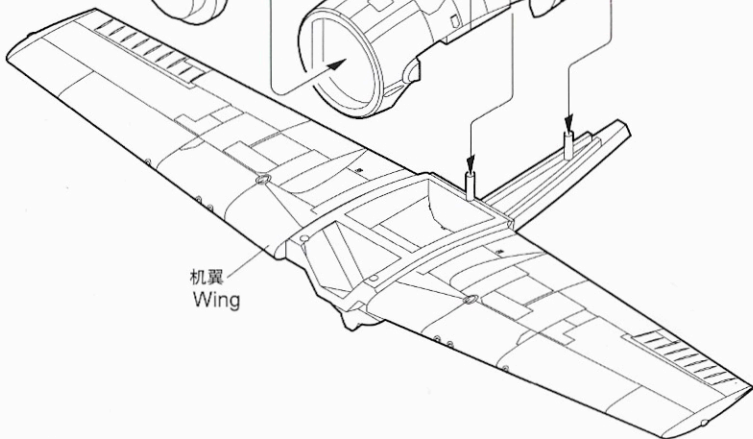

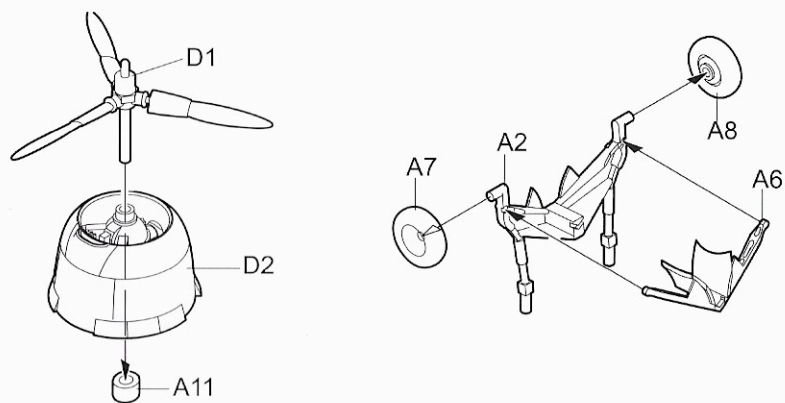
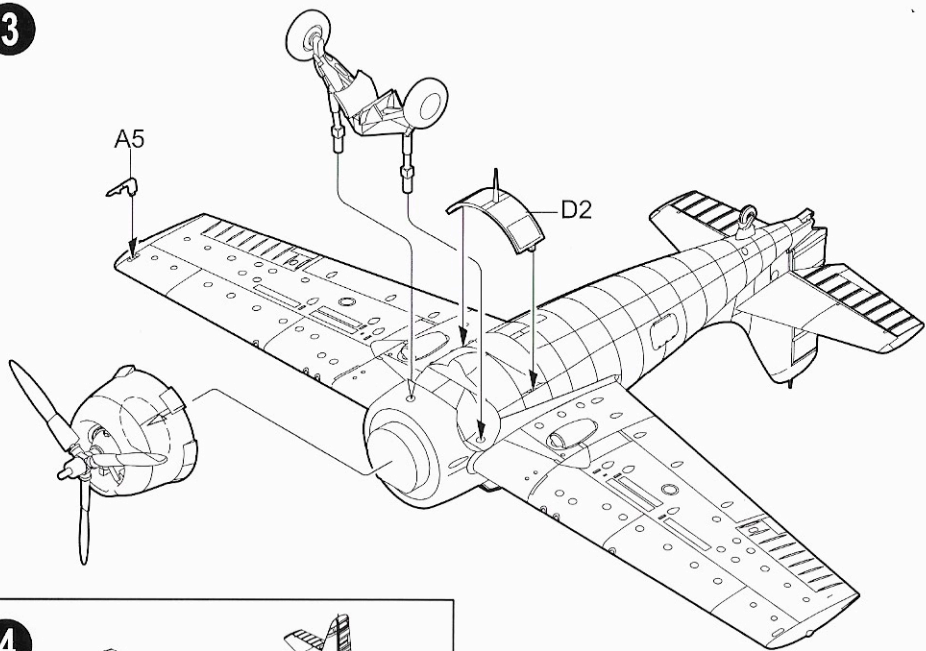
2**3****4**