

## RAF 6 Squadron History

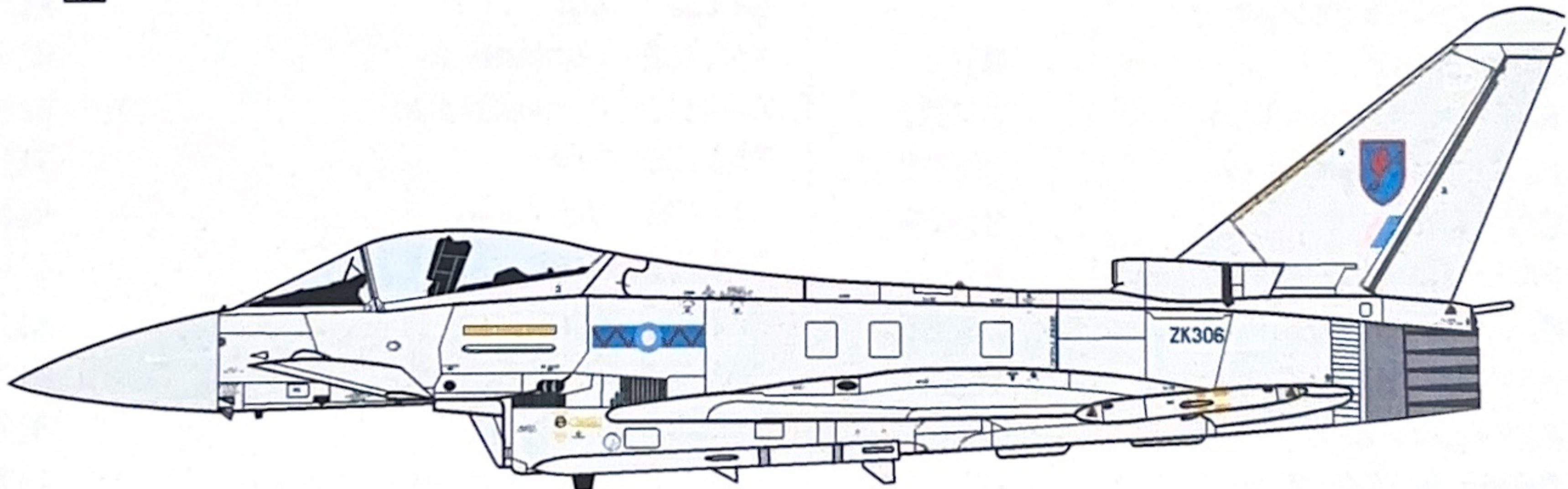
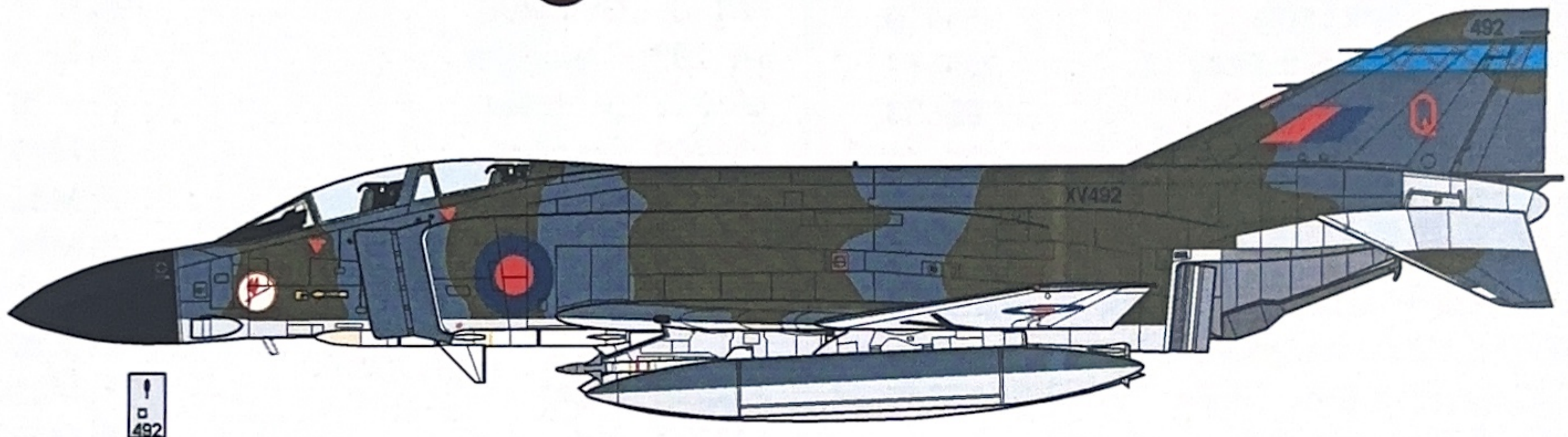
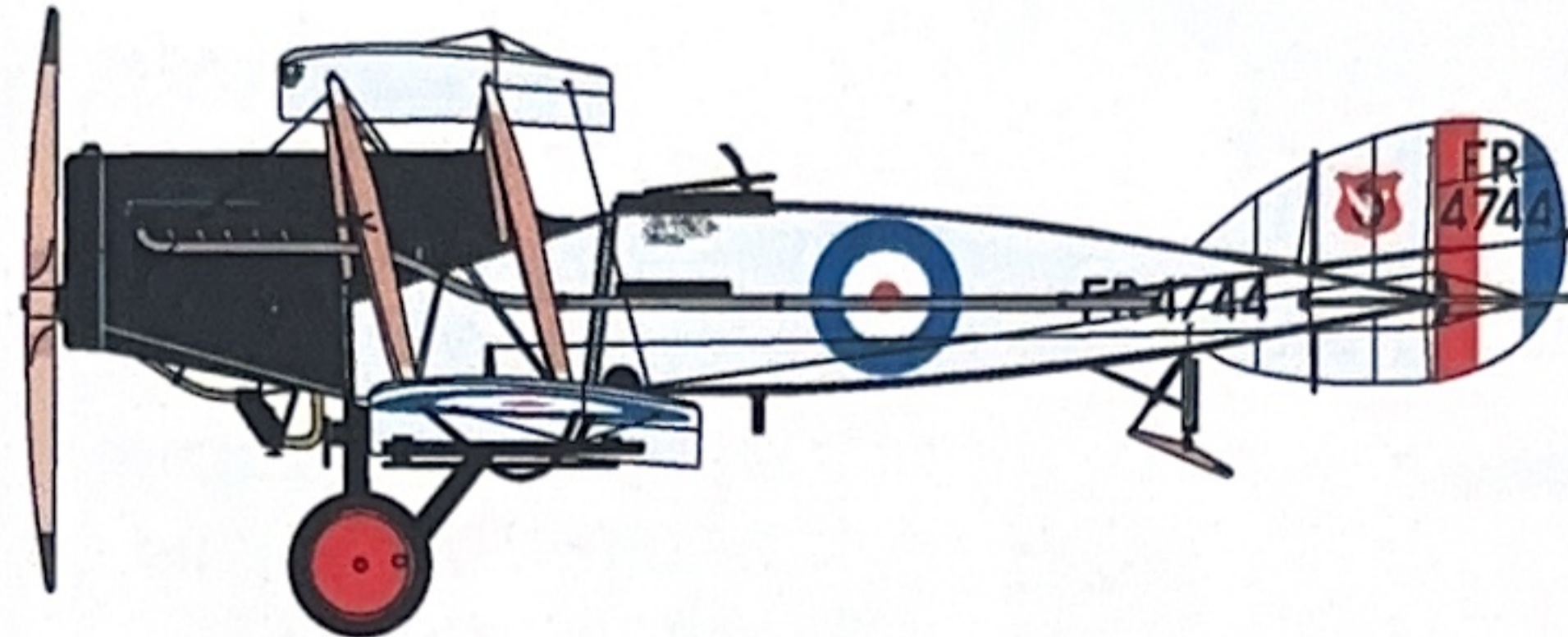

For the best results these decals should be applied to a gloss surface such as provided by either Xtracolor or Xtracrylix paints. Cut out the decal required and soak in warm water until the decal is released from the backing paper. Wet the area to be decaled with MICRO SET which will help to eliminate air trapped under the decal and position the decal.

After 5 or 10 minutes wet the decal with MICRO SOL which will soften the decal and ensure that it settles down over any surface detail. Allow the decal to dry for at least 12 hours. During this time some wrinkling of the decal may occur, this is normal. Do not touch the decal at this time.

Carefully check for small air bubbles and if there are any prick with a needle and apply a drop of MICRO SOL. After all air bubbles have been eliminated and the decals are dry wash the entire model with water to remove any excess decal adhesive.

When completely dry the whole model should be sprayed with a coat of Xtracolor or Xtracrylix with a coat of Flat, Satin or Gloss varnish depending on the finish required.

Store in a cool dry place, avoid sunlight, dampness or extremes of temperature and/or humidity.



### Royal Air Force WWII and Modern

XA1001	RAF Dark Green	BS241
XA1002	RAF Dark Earth	BS450
XA1003	RAF Med. Sea Grey	BS637
XA1004	RAF Dark Sea Grey	BS638
XA1005	RAF Extra Dark Sea	BS640
XA1006	RAF Ocean Grey	
XA1007	RAF Sky	BS210
XA1008	RAF PRU Blue	BS636
XA1009	RAF Middle Stone	
XA1010	Aircraft Grey/Green	BS283
XA1011	RAF Trainer Yellow	
XA1012	Night Black	BS642
XA1014	RAF Red Arrows Red	BS537
XA1015	RAF Lt Aircraft Grey	BS627
XA1016	RAF Hemp	BS389
XA1017	RAF Camouflage (Barley) Grey	BS626
XA1019	RAF Rescue Yellow	BS356
XA1025	RAF Dark Slate Grey	BS634
XA1026	RAF Azure Blue	
XA1032	Desert Pink Gulf War	FS10279
XA1036	RAF Dk Camo Grey	BS629
XA1037	RAF Lt Slate Grey	BS639

### U.S.A.F. U.S.N. U.S.M.C

FS Numbers refer to FS595B

XA1114	Medium Green	FS14092
XA1116	Green Vietnam	FS14102
XA1117	Interior Green	FS34151
XA1121	Gloss Sea Blue	FS15042
XA1125	Intermediate Blue	FS15164
XA1126	Dark Blue/Grey	FS15237
XA1129	Dark Grey	FS16081
XA1130	Gunship Grey	FS16118
XA1131	Dark Gull Grey	FS16231
XA1132	Medium Grey - Mod Eagle	FS16251
XA1133	Neutral Grey	FS16270
XA1135	Dark Compass Grey	FS16320
XA1136	Light Compass Grey	FS16375

XA1137	Light Gull Grey	FS16440
XA1138	ADC Grey	FS16473
XA1139	Light Grey	FS16495
XA1140	Light Grey	FS16622
XA1141	White	FS17875
XA1157	Dk Grey Mod Eagle	FS16176
XA1158	AMC Battle Grey	FS16173

### LUFTWAFFE WWII

XA1201	Grau	RLM02
XA1202	Hellblau	RLM65
XA1203	Schwarzgrau	RLM66
XA1204	Schwarzgrun	RLM70
XA1205	Dunkelgrun	RLM71
XA1206	Graugrun	RLM74
XA1207	Grauviolet	RLM75
XA1208	Lichtblau	RLM76
XA1209	Sandgelb	RLM79
XA1210	Braunviolett	RLM81
XA1213	Gelb	RLM04
XA1214	Hellblau	RLM78
XA1215	Grun	RLM80
XA1216	Silber	RLM01
XA1217	Rot	RLM23
XA1218	Dunkelblau	RLM24
XA1219	Dunkelbraun	RLM61
XA1220	Grun	RLM62
XA1221	Lichtgrau	RLM63
XA1222	Grun	RLM72
XA1223	Grun	RLM73
XA1224	Sand Braun	RLM79a
XA1225	Hellgrun	RLM82
XA1226	Dunkelgrun	RLM83

### VARNISHES

XA1G	16ml Gloss Varnish
XA1GG	100ml Gloss Varnish
XA1FF	100ml Flat Varnish
XA1SS	100ml Satin Varnish

### THINNERS

XA1TT	100ml Thinners
XA1TTT	300ml Thinners

The NEW Standard in Decal Ready Accurate  
Authentic ACRYLIC Model Paint.

Resists Masking Tape  
Hand Brush or Spray - Quick Drying

**In 16ml screw top jars**

**Bristol F2B, FR4744** of No.6 Sqn., Ismailia, Egypt, Circa February 1931. (Ref: R & A Vernon files). "R" in the serial indicates a re-built aircraft. Contemporary photos show no under wing serials.

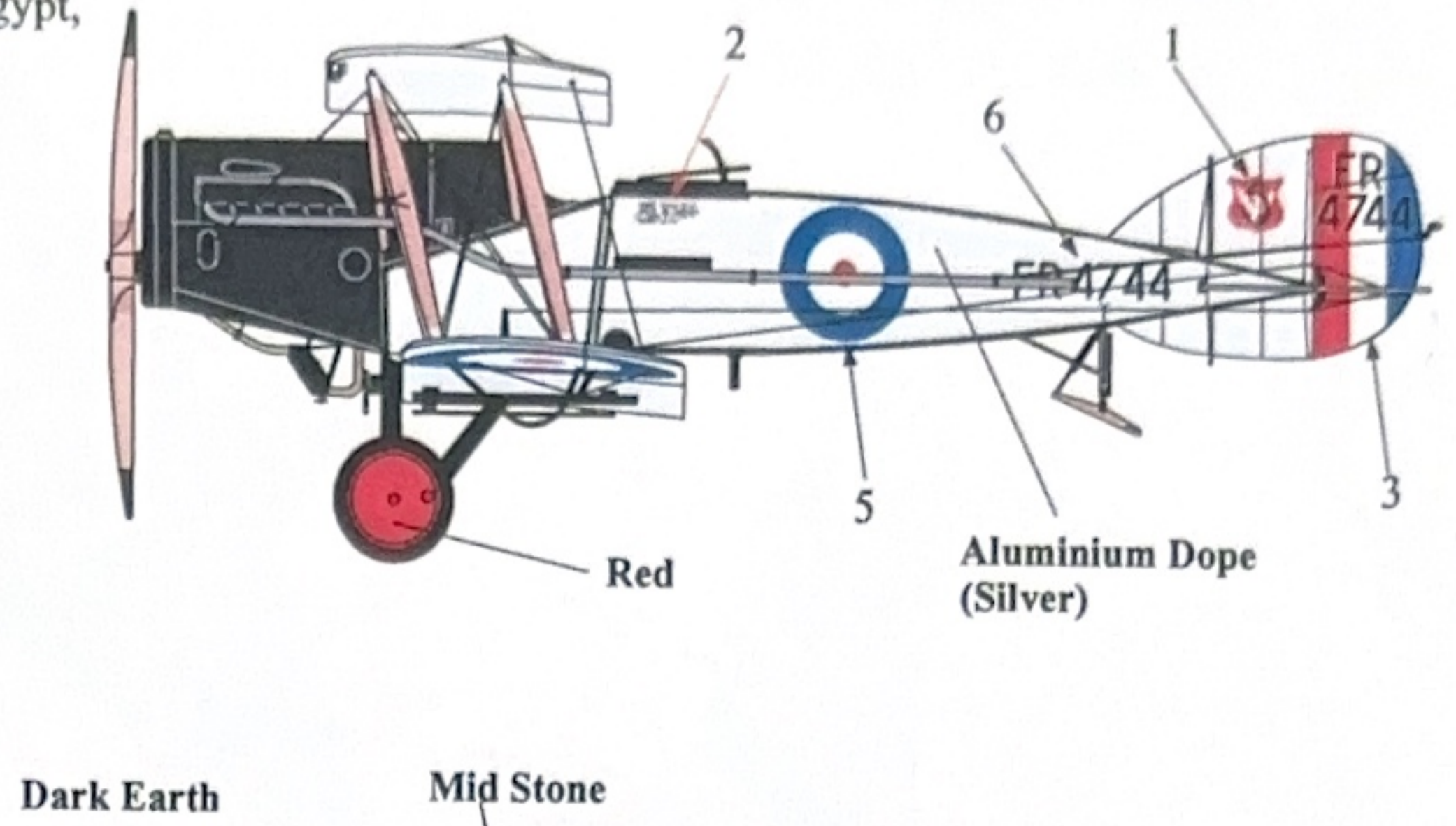
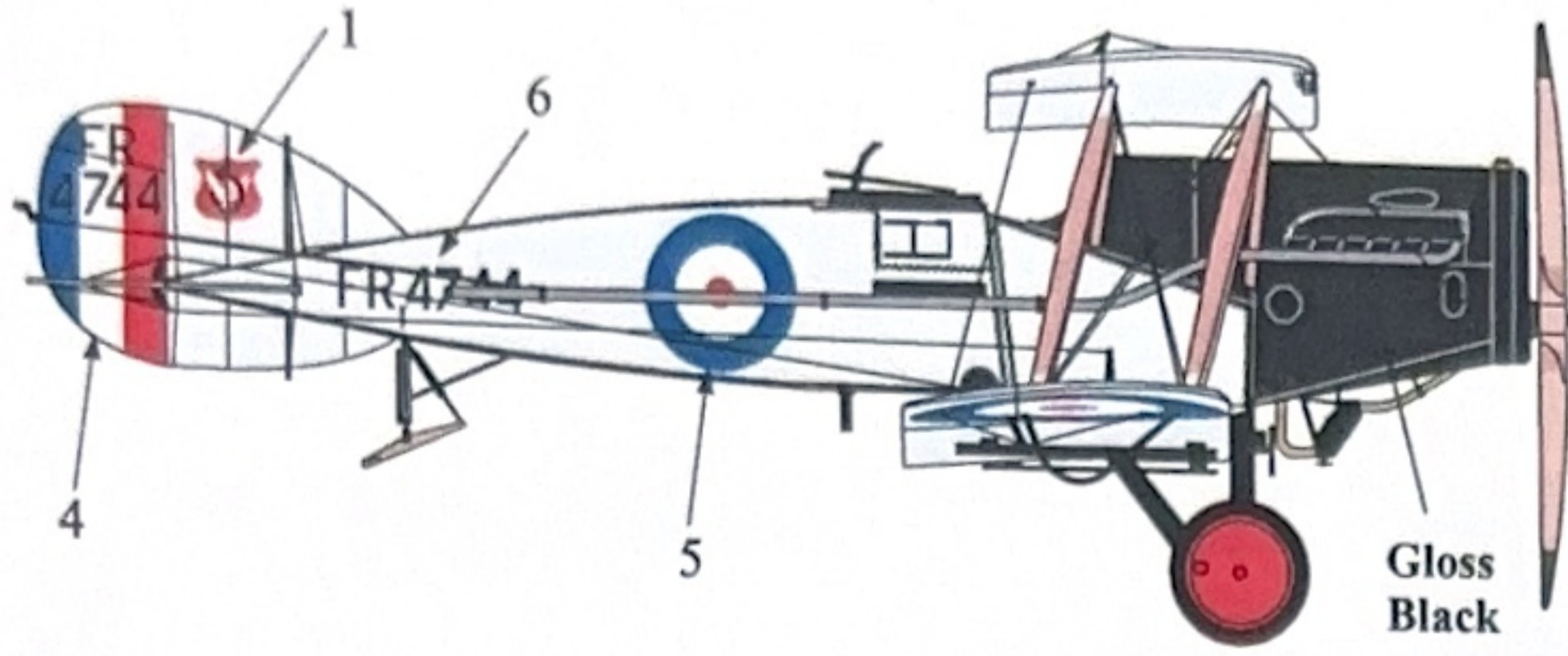

**Hawker Hurricane Mk.IID, HV663/U** of No. 6 Sqn., Gabes, Tunisia, 6 April 1943. (Ref: IMW Colour photo).

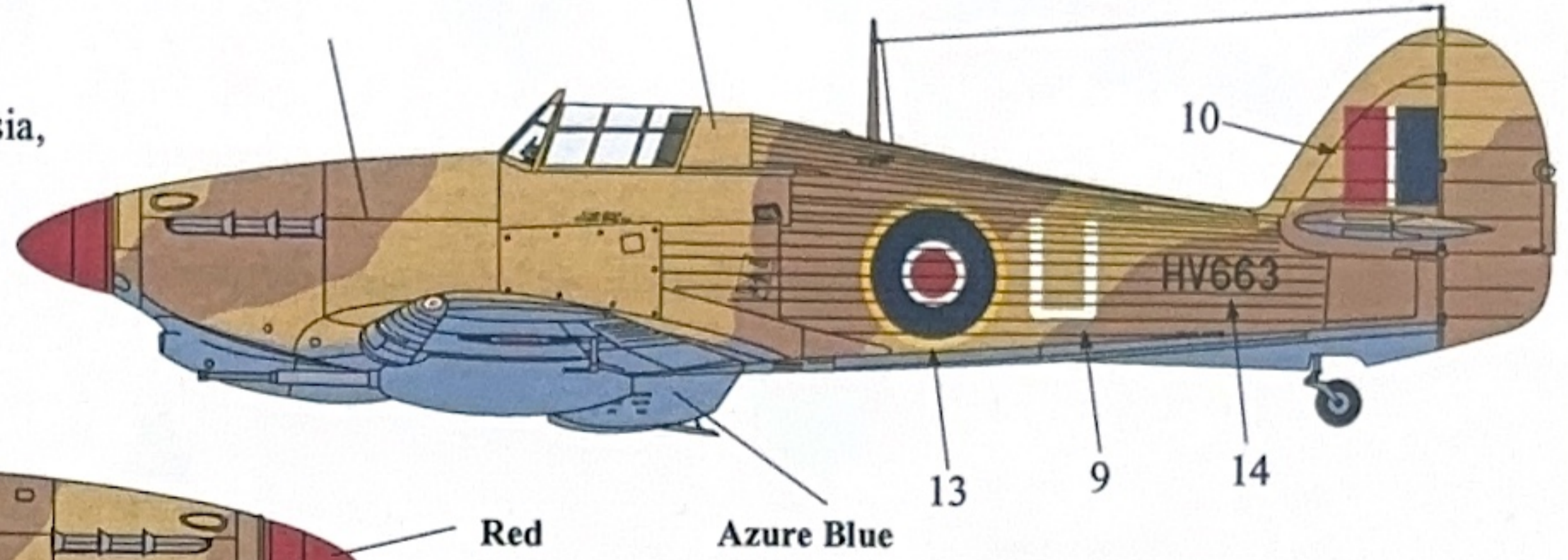
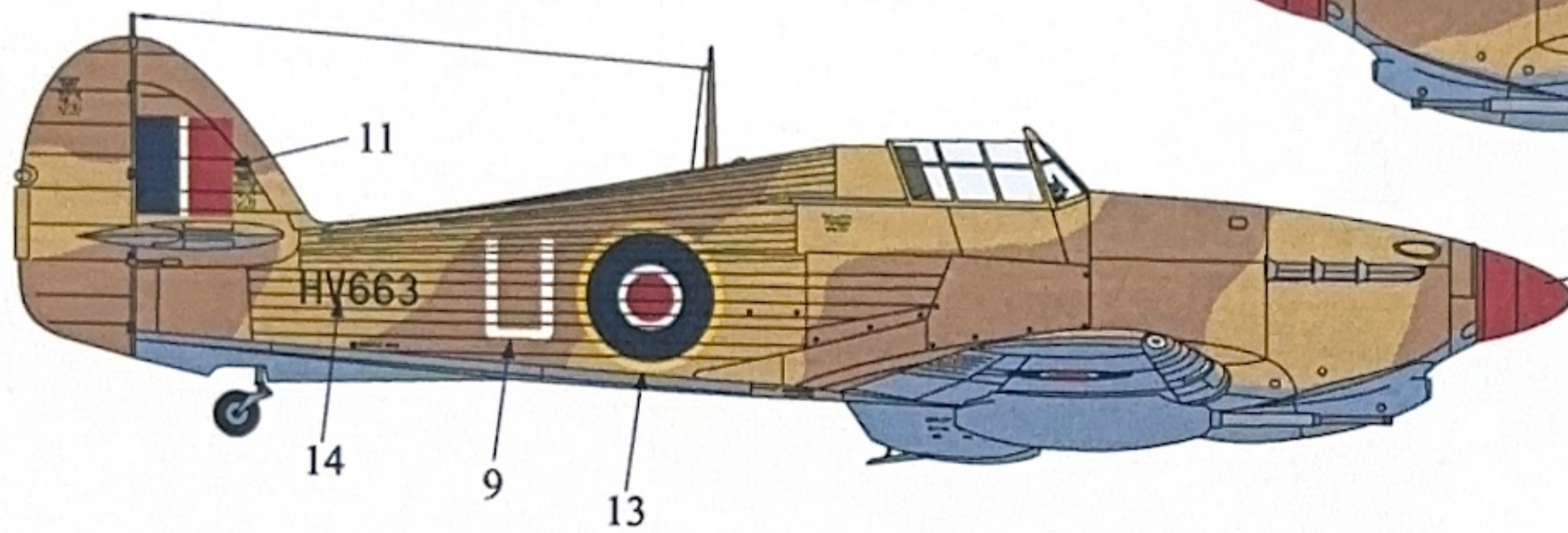

**McDonald Phantom FGR.2, XV492/Q** of No.6 Sqn., RAF Coningsby, in August 1974. (Ref: R.L Ward - Phantom Sqns, P.7). Note: Matt finish.

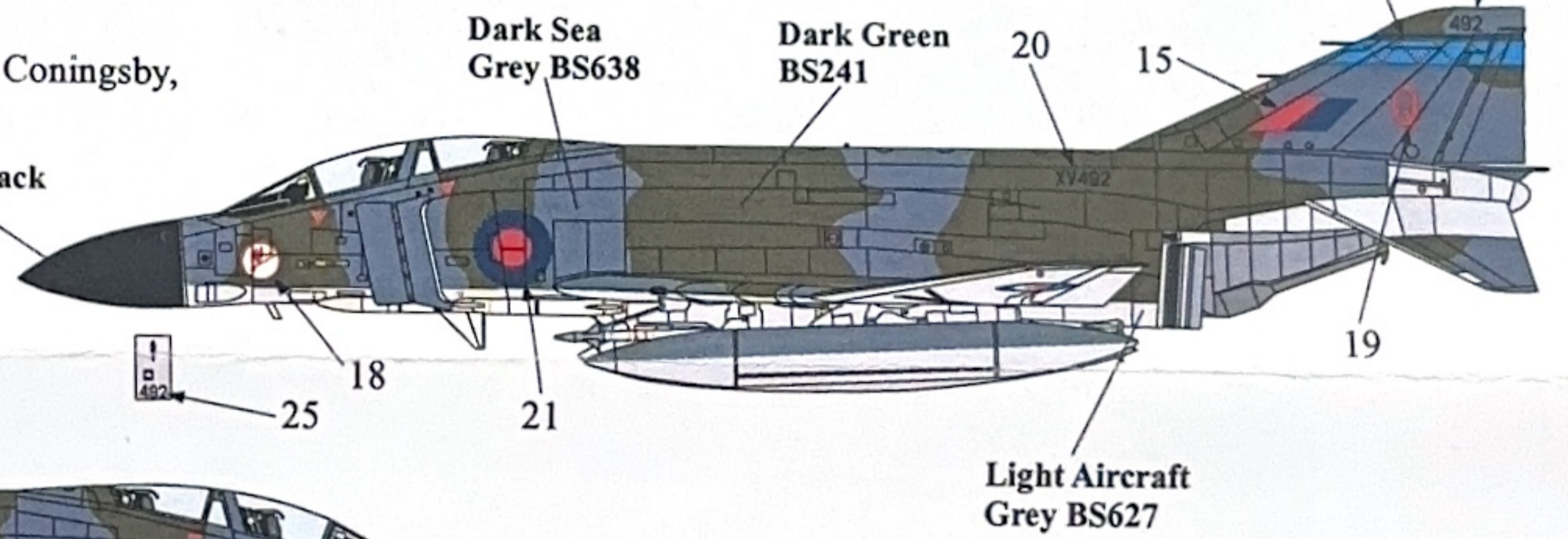
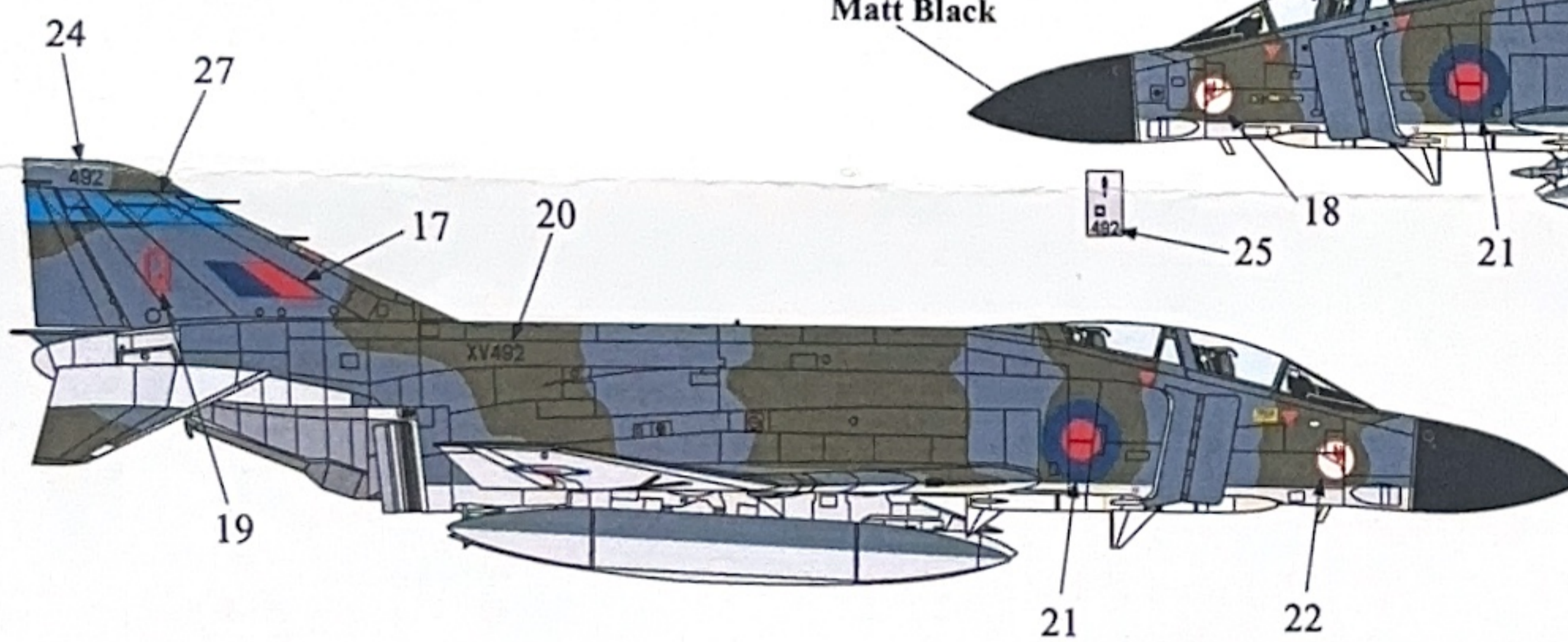

**SEPECAT Jaguar GR.1, XX766/EA**, flown by Wg.Cdr. A.D. Sweetman BA, OC No.6 Sqn., 76th Anniversary, RAF Coltishall, in 1989. (Ref: Watson - RAF Jaguar P55).

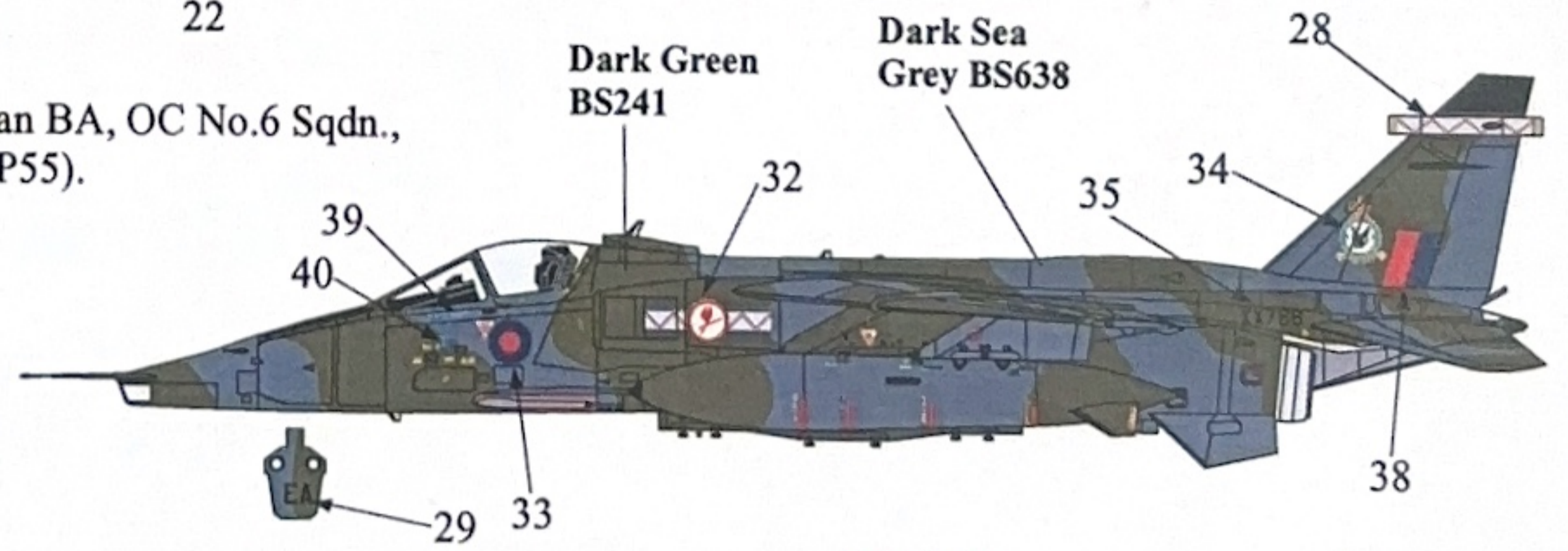
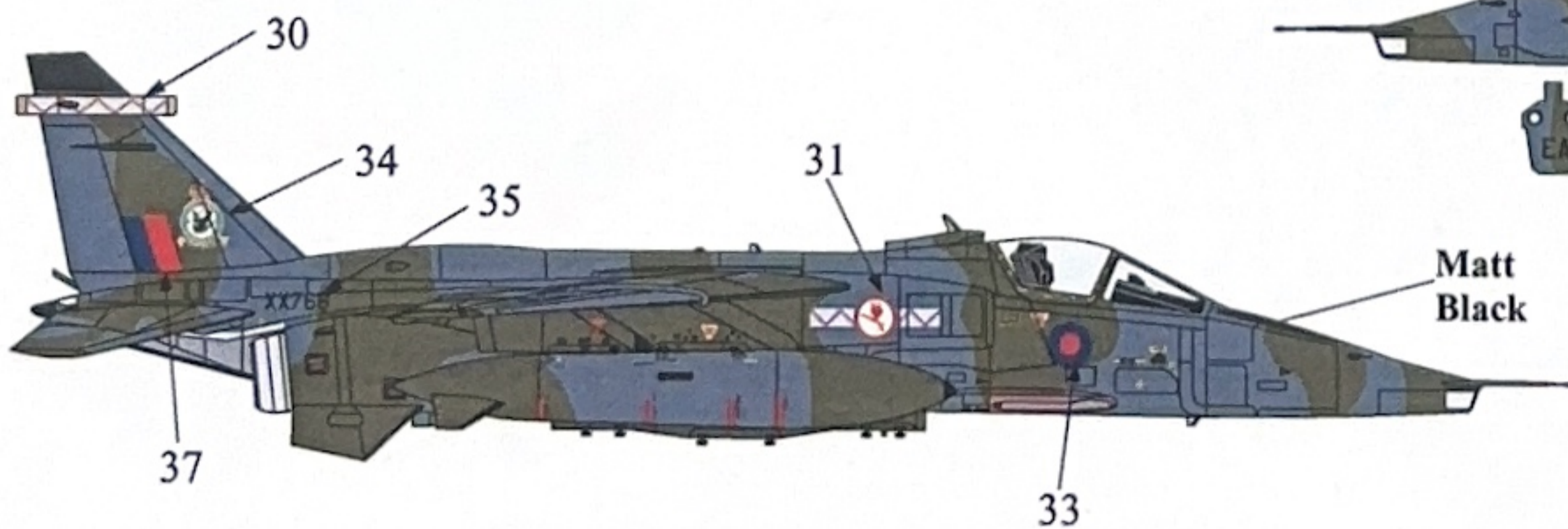

**OPTION:**  
 "Operational" finish pre application of Anniversary Squadron Badge.

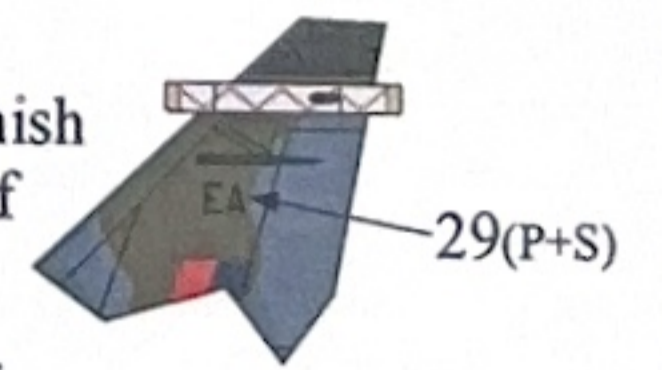

**Eurofighter Typhoon FGR.4, ZK306/ED**, flown by Flt. Lt. C. Brough, of No.6 Sqn., RAF Coningsby & Leuchars, September/ October 2010. (Ref: T. Senior Photo; Airlines.Net).

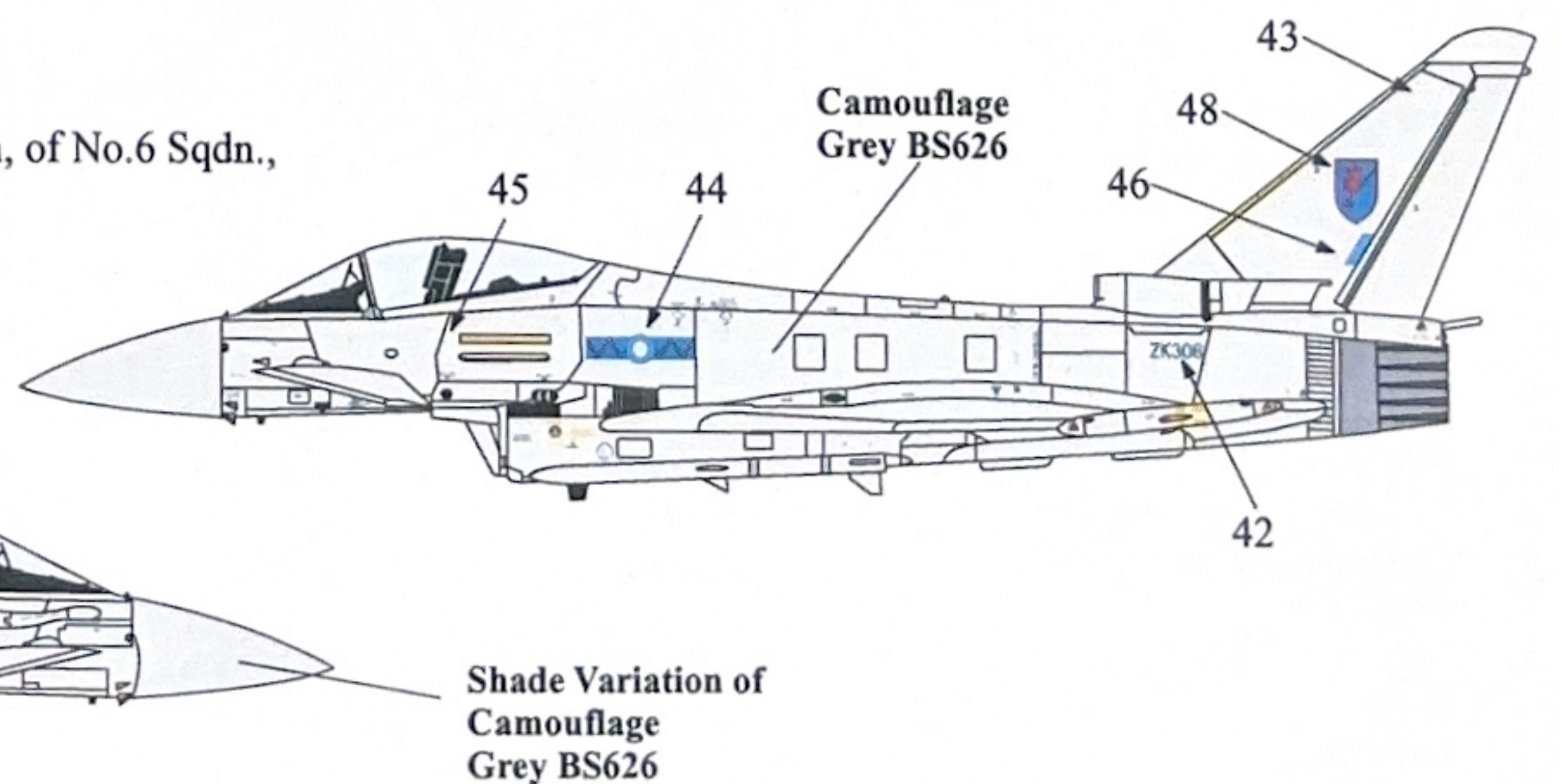
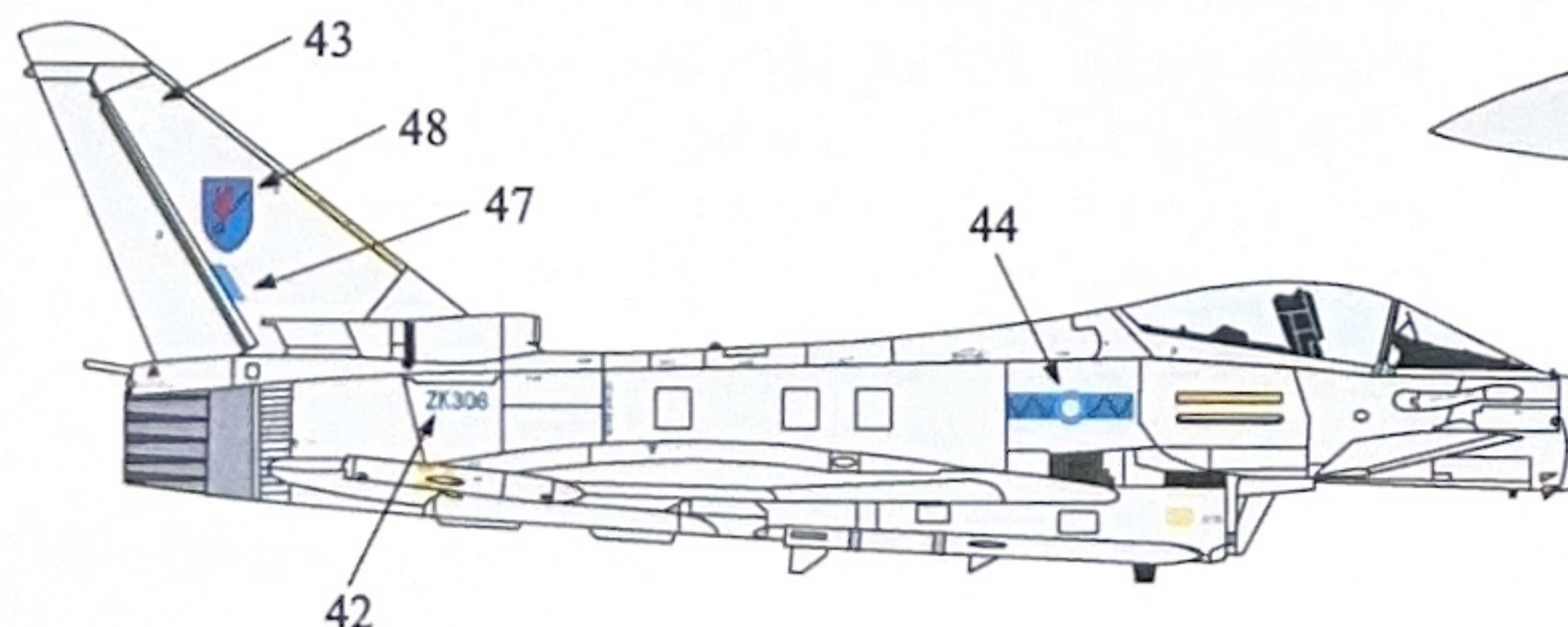

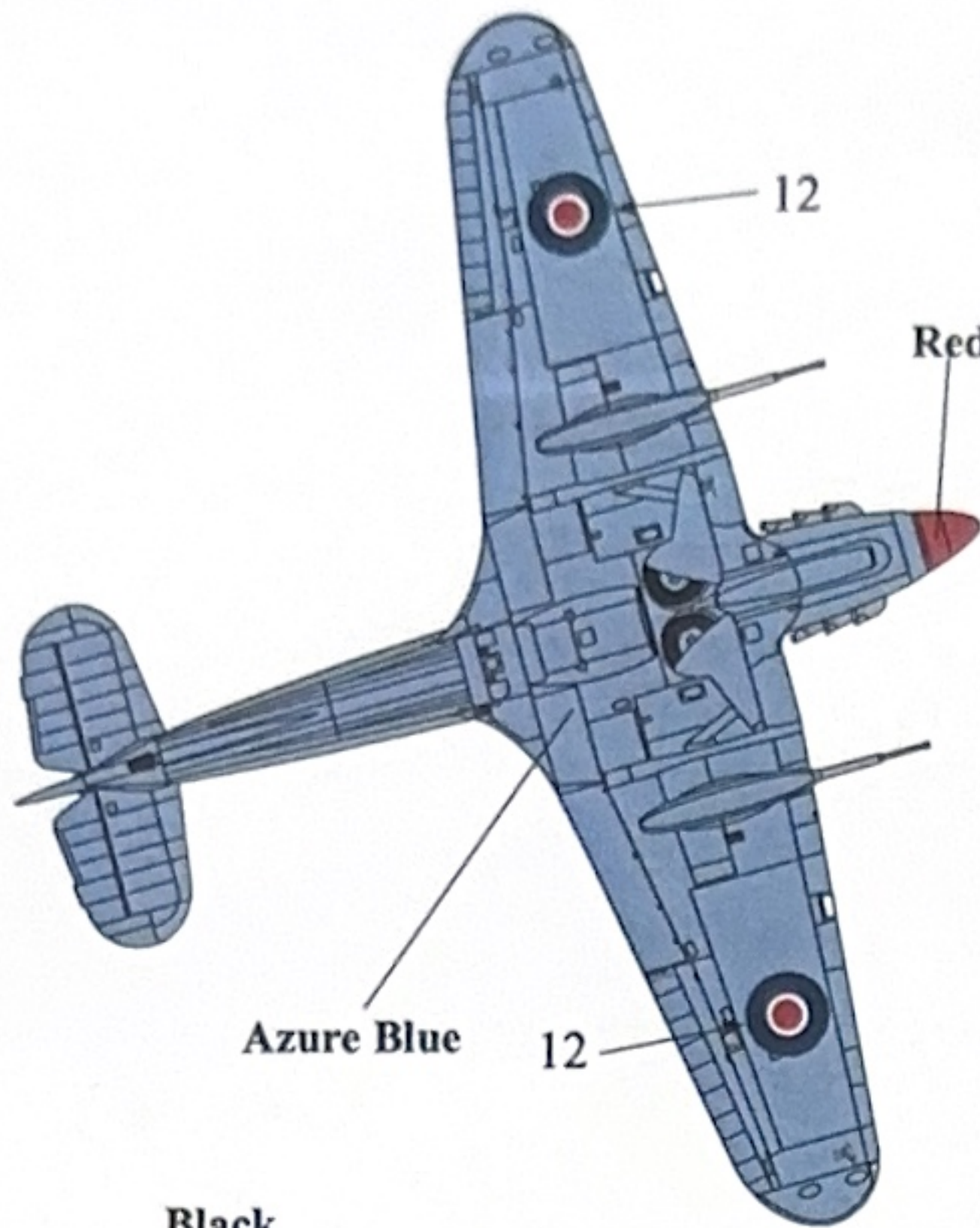

Azure Blue 12

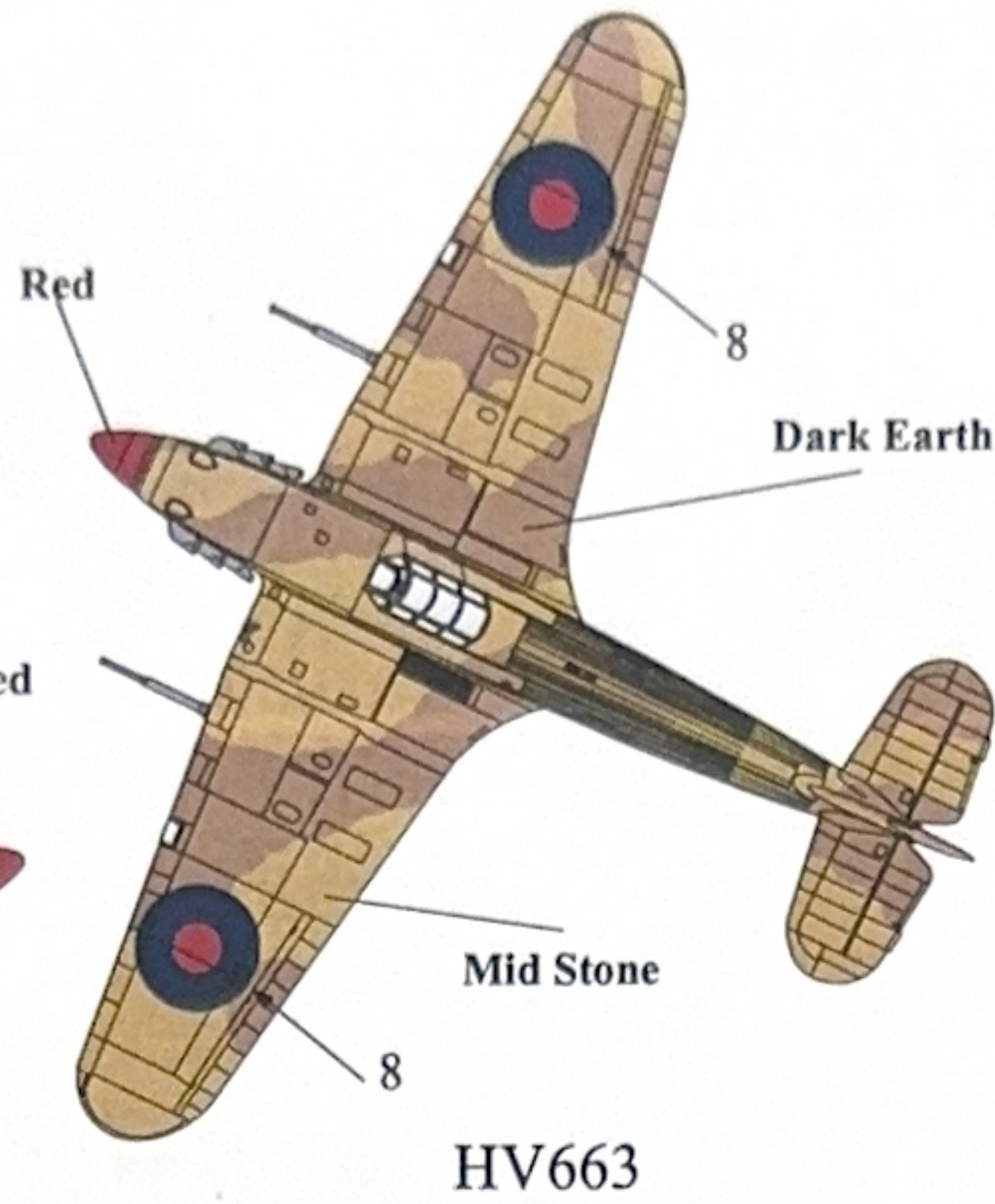

HV663

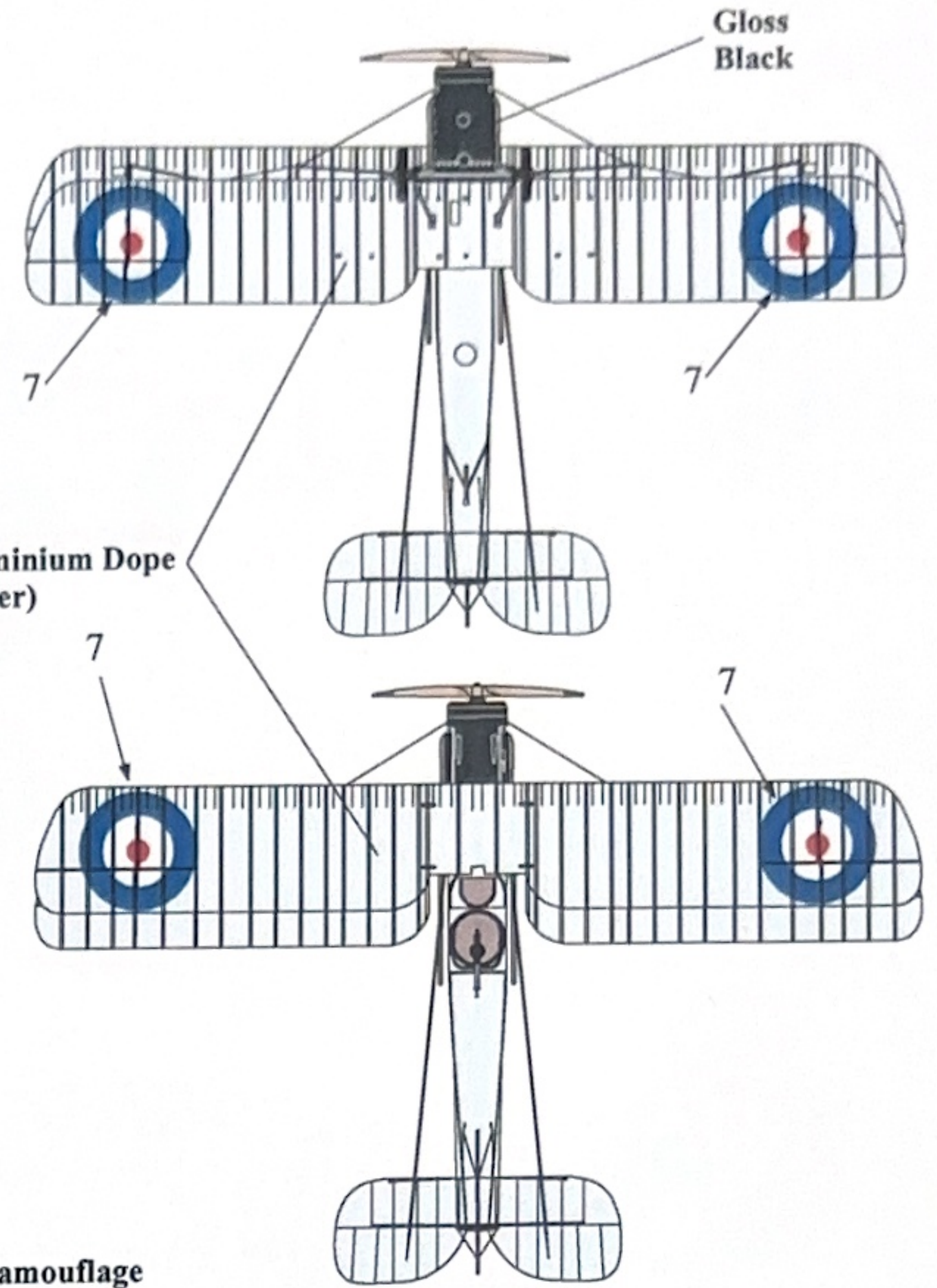

Aluminium Dope (Silver)

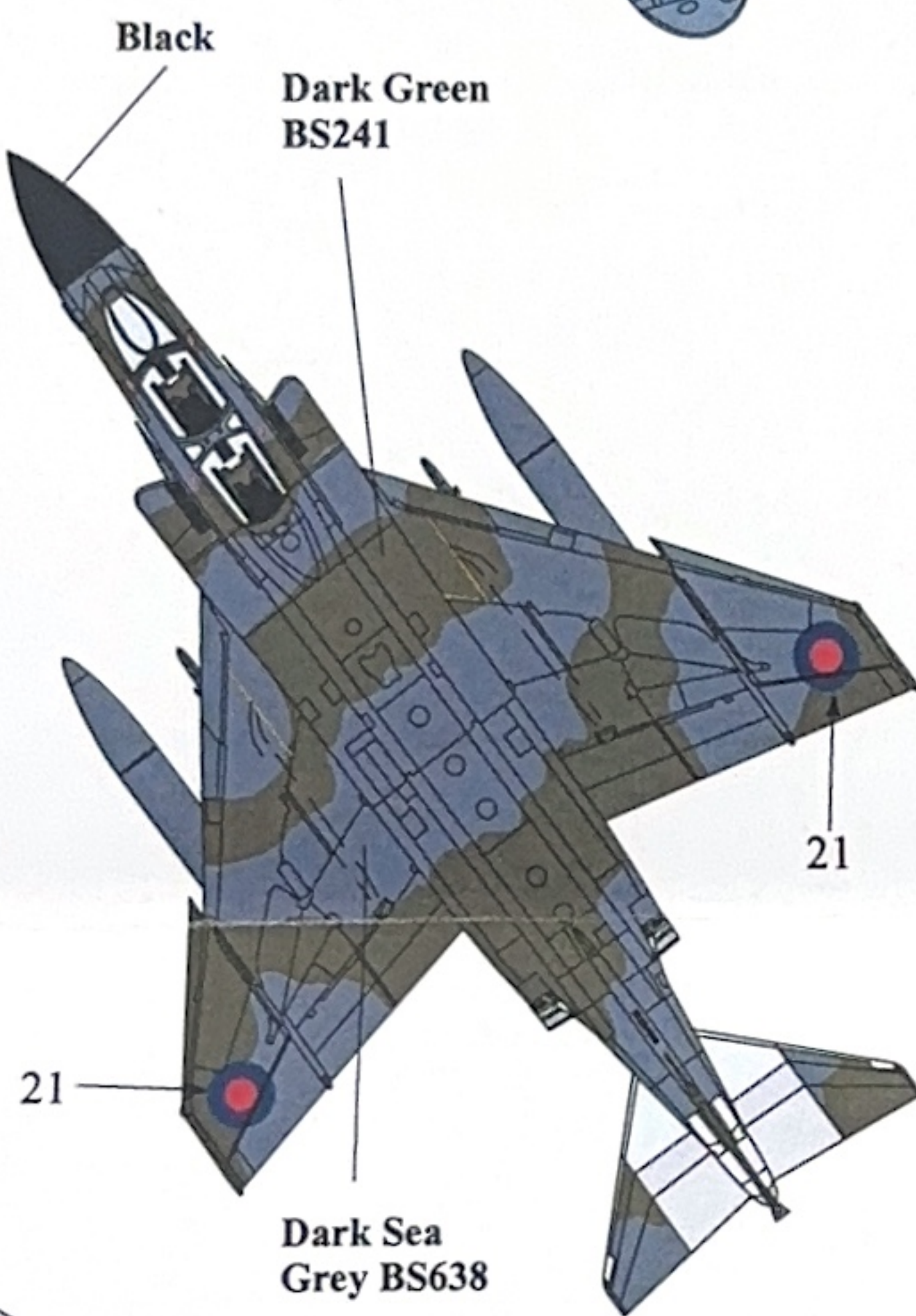

Dark Sea Grey BS638

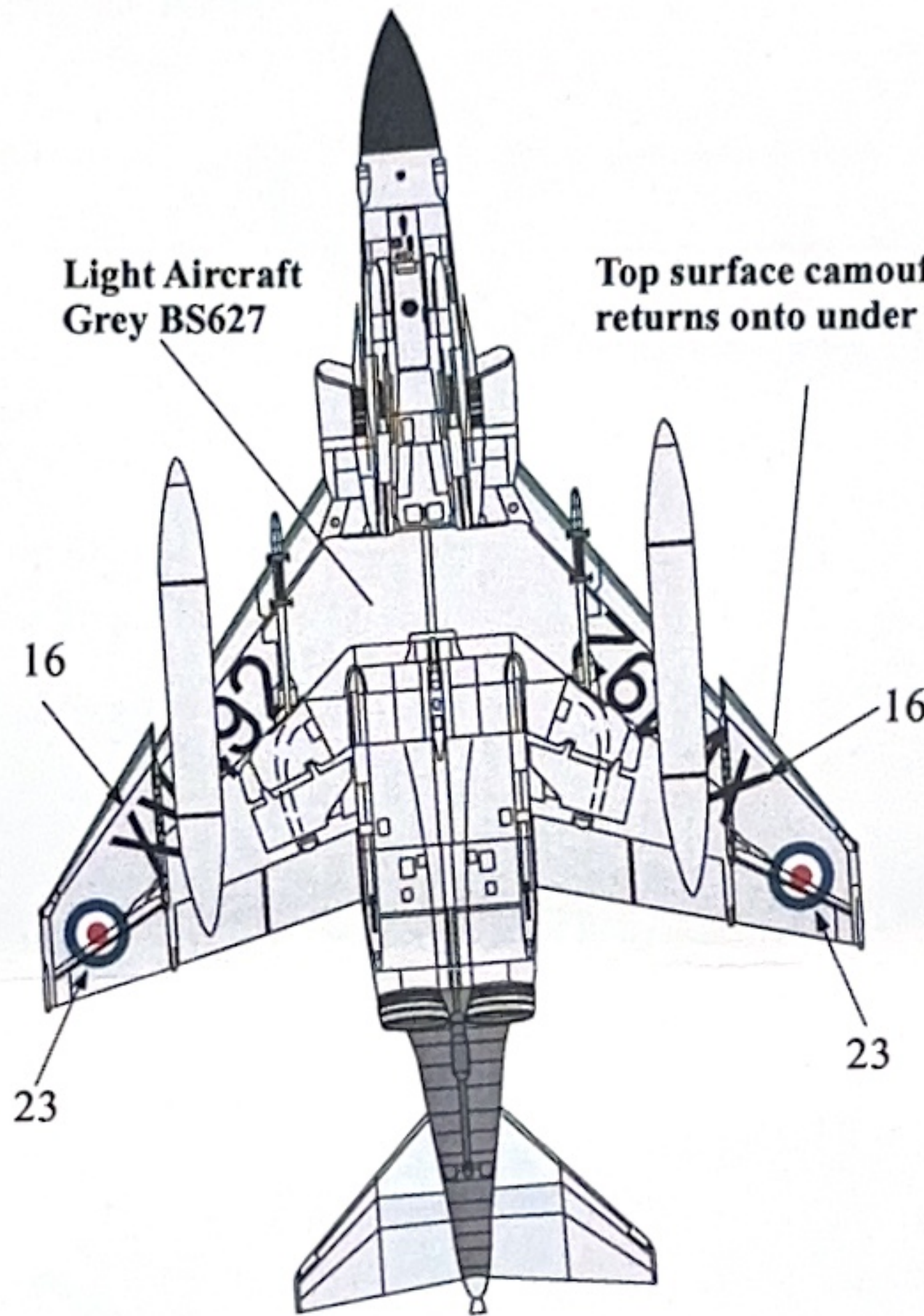

Light Aircraft Grey BS627

Top surface camouflage returns onto under wing.

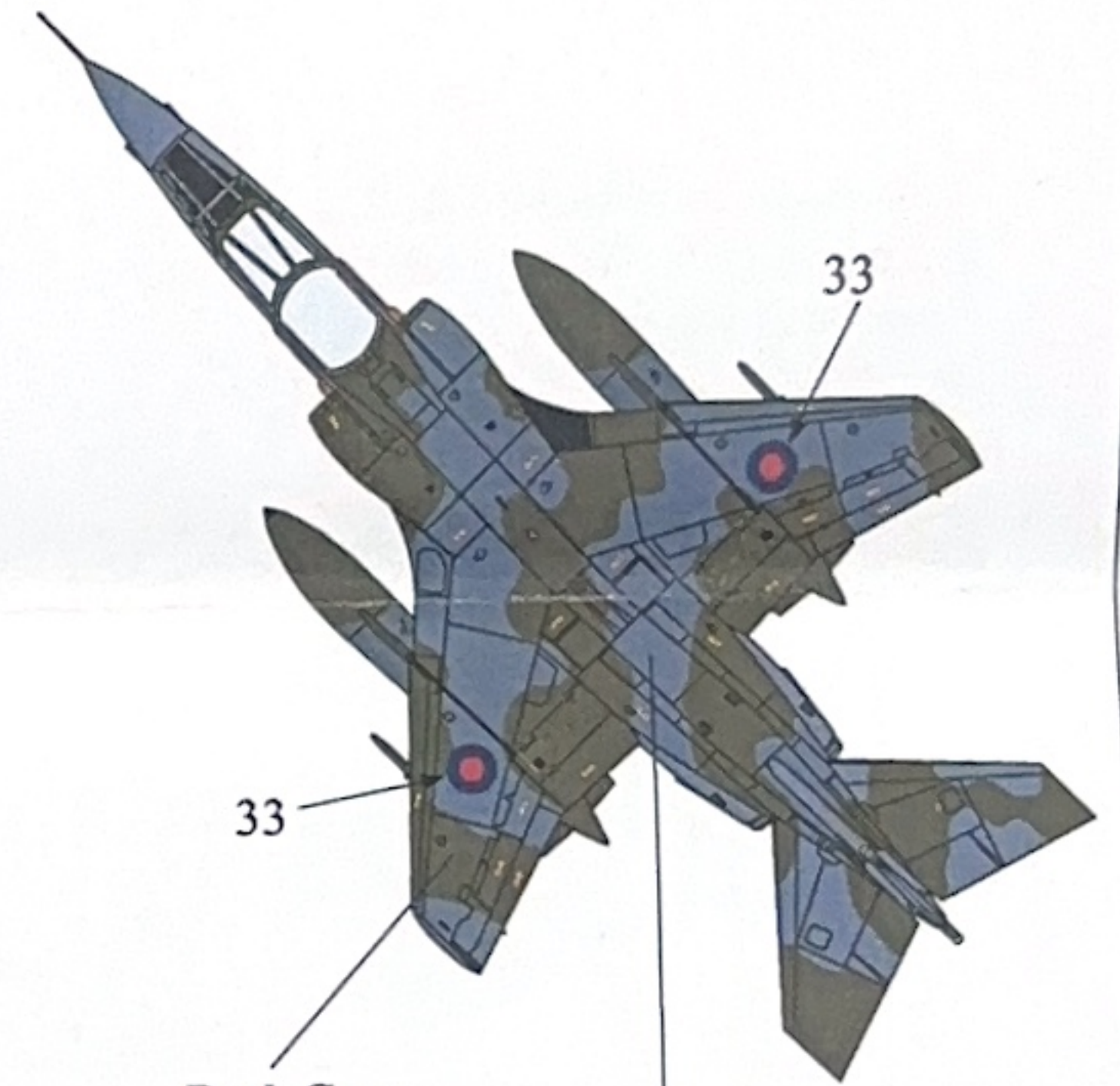

Dark Green BS241

Dark Sea Grey BS638

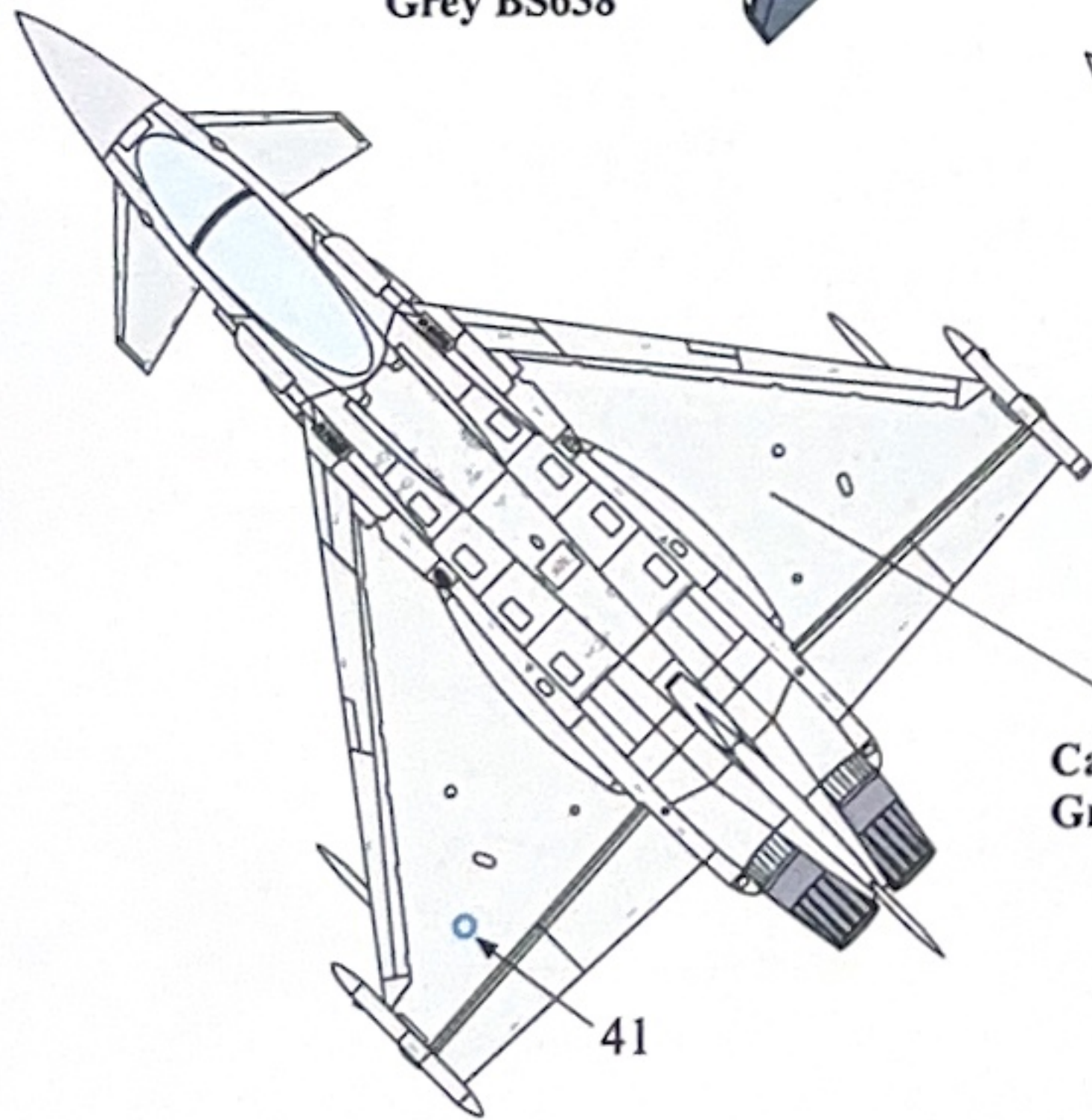

Camouflage Grey BS626

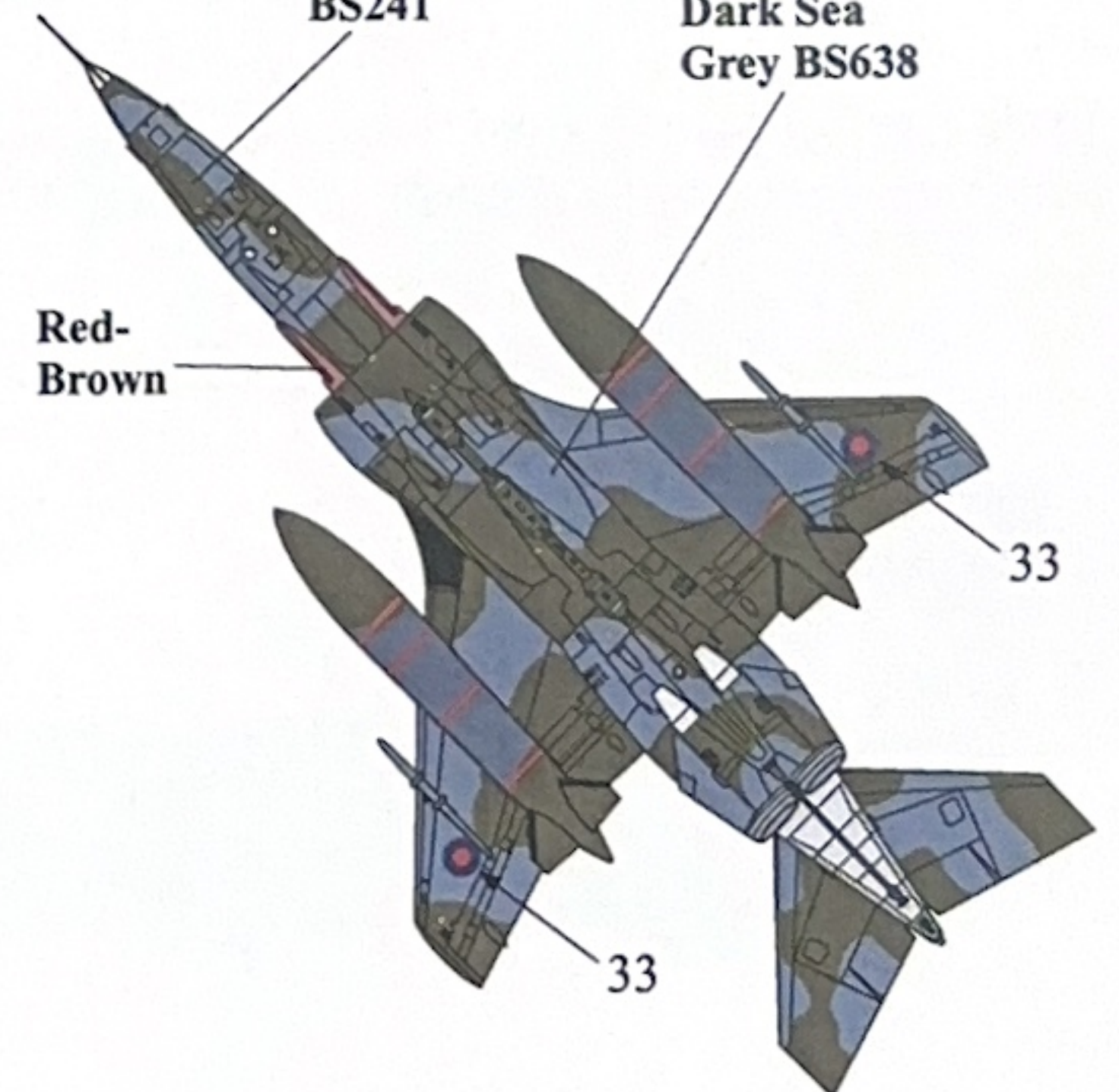
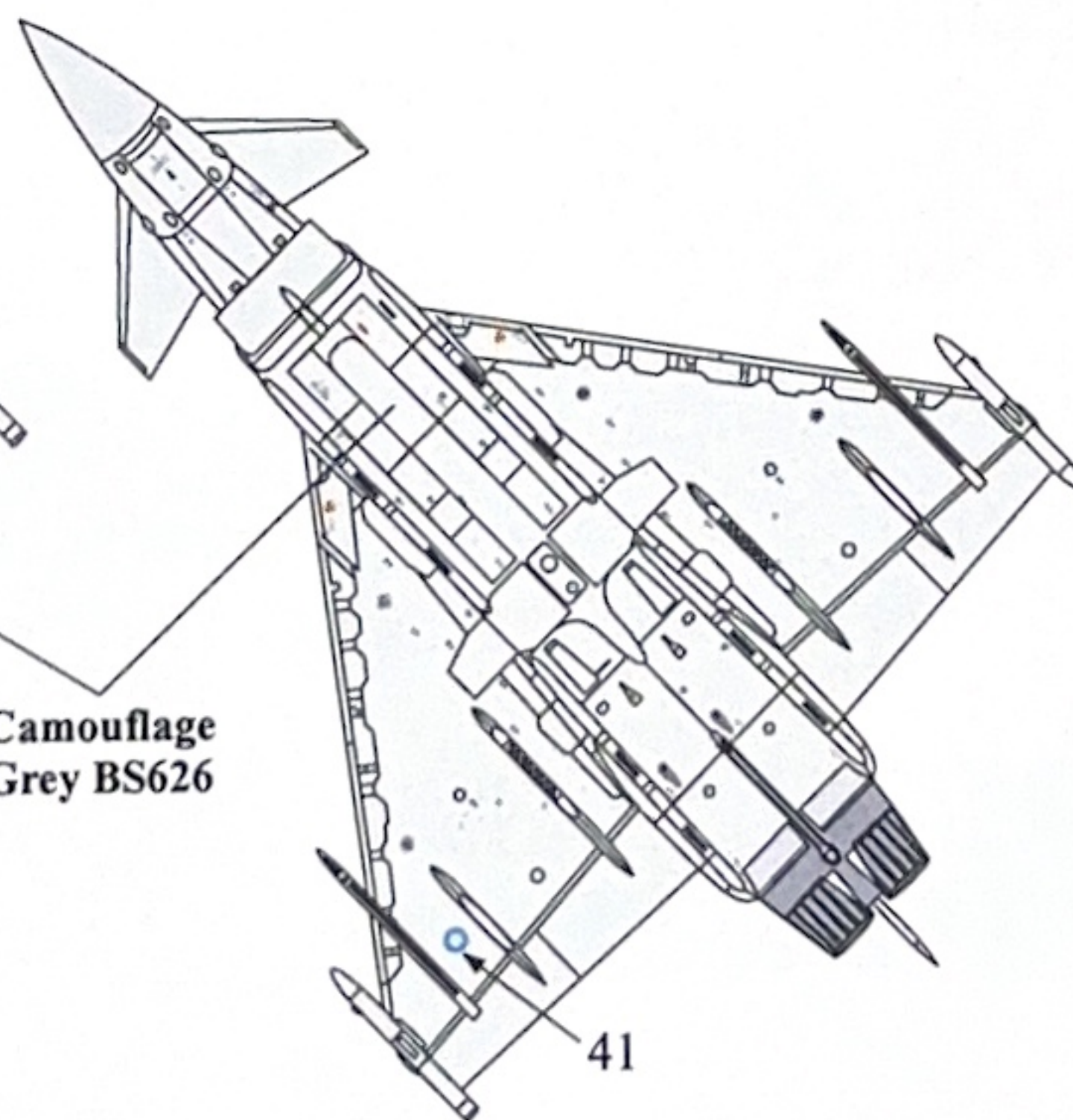

Red-Brown

**Xtracolor Paints:**

- Dk.Green BS241 X001
- Dark Earth X002
- Med.Sea Grey BS637 X003
- Dk.Sea Grey BS638 X004
- Ocean Grey X006
- Sky X007
- Mid Stone X009
- Lt.Aircraft Grey BS627 X015
- Camouflage Grey BS626 X017
- Azure Blue X026
- High Speed Silver X038
- White X141
- Matt Black X404

**Xtracrylix Paints:**

- Dk.Green BS241 XA1001
- Dark Earth XA1002
- Med.Sea Grey BS637 XA1003
- Dk.Sea Grey BS638 XA1004
- Ocean Grey XA1006
- Sky XA1007
- Mid Stone XA1009
- Night (Black) XA0112
- Lt.Aircraft Grey BS627 XA1015
- Camouflage Grey BS626 XA1017
- Azure Blue XA1026
- High Speed Silver (Silver) XA1216
- White XA1141

**Acknowledgements:**

The assistance of No.6 Squadron Association, in particular, Allen and Richard Vernon, who's unstinting provision of previously unseen details and photographs was invaluable, and is gratefully acknowledged - Many Thanks.

**NOTE: Use kit decals as appropriate.**