

Sd.Kfz.181 Pz.Kpfw.VI Ausf.E

Mid-Production

Battle of Malonovka

Otto Carius

PROVERBIA

DRAGON
Zimmerit

TIGER I



DRAGON

YOKOTA/B

Project supervised by HIROHISA TAKADA. Technical drawings provided by MINORU IGARASHI.
Technical assistance provided by DAVID BYRDEN.
Thanks to TOM COCKLE and GARY EDMUNDSON as Technical Consultants.

KIT NO. 6888

A **B** **C** **E**

W **Y** **F** **R**

Qx2 **J**

Y **K** **P** **V**

U **T** **U**

Hx4 **T**

Wx2 **D** **MA (Photo-etched Parts)**

MB (Metal Parts) **TB (Photo-etched Parts)**

中国語説明書は、こちら
 中国語説明書は、こちら
 中国語説明書は、こちら
 中国語説明書は、こちら

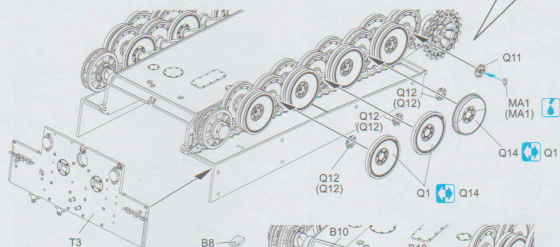
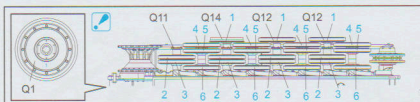
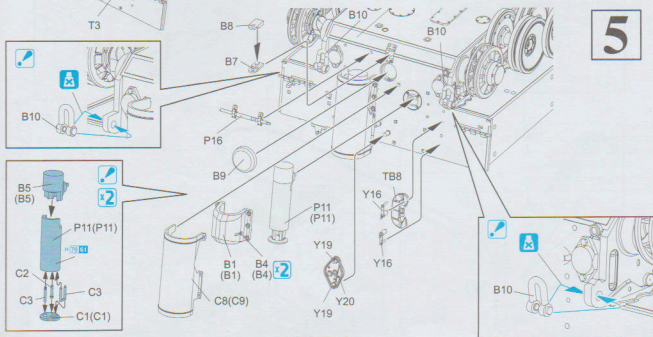
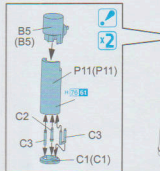
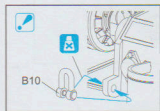
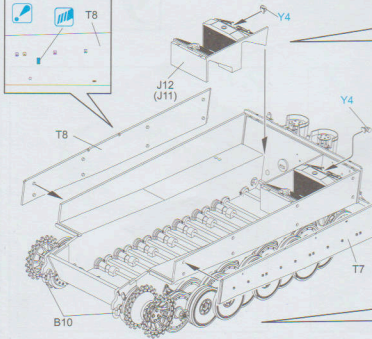
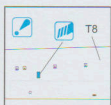
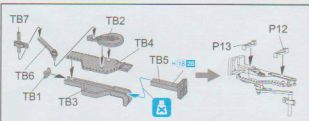
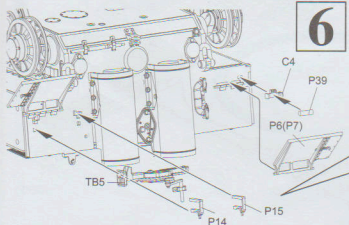
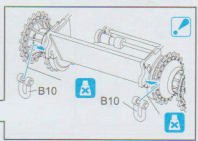
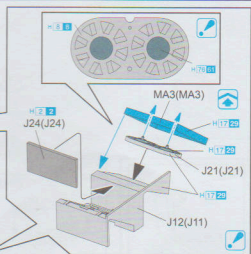
4**5****6****7**

8

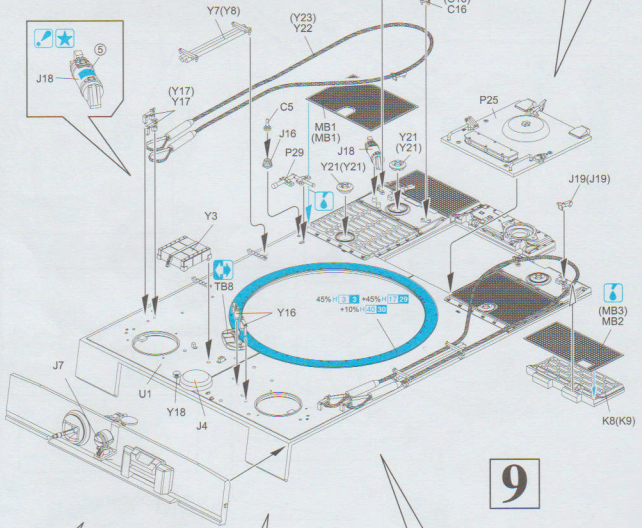
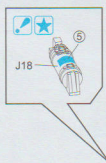
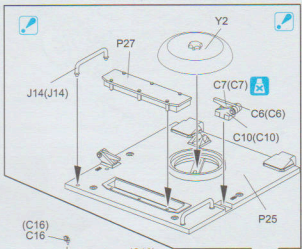
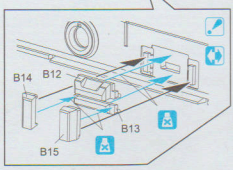
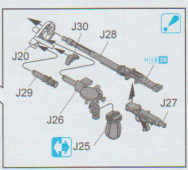
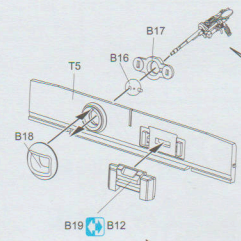

9

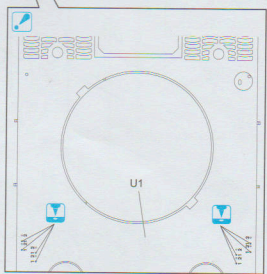
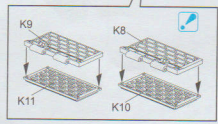
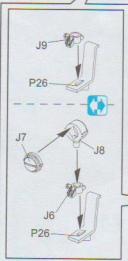

10

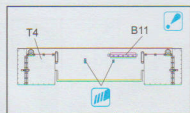
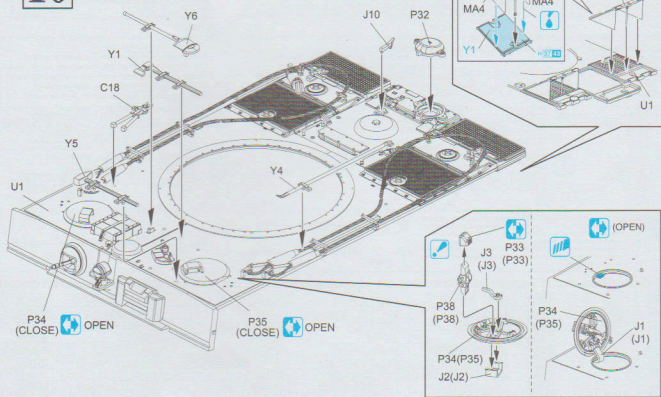

11

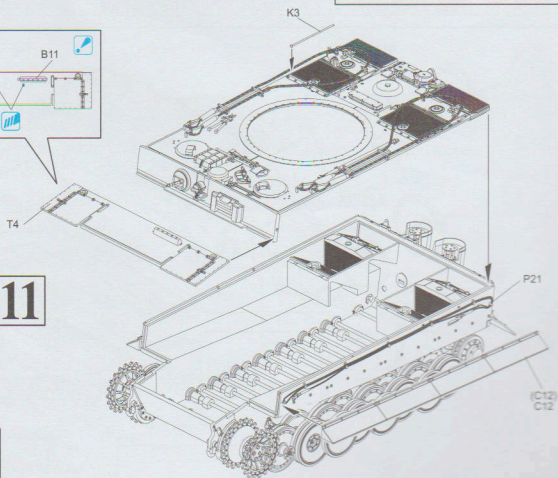

12

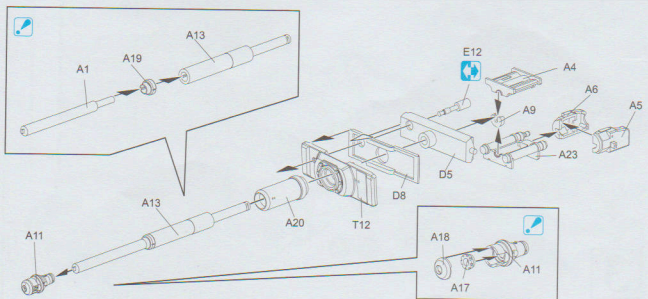

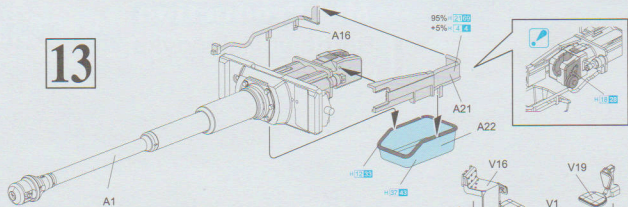
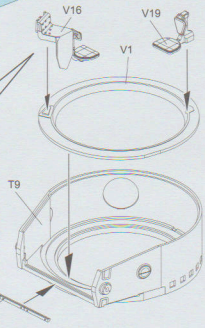
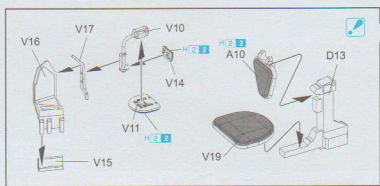
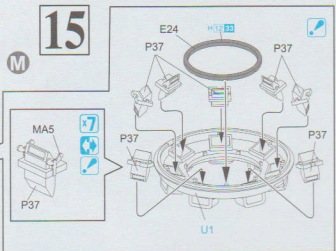
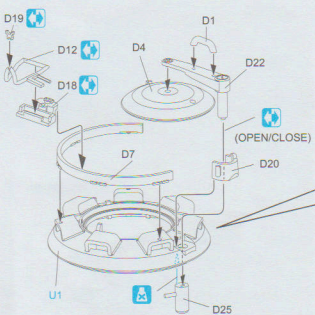
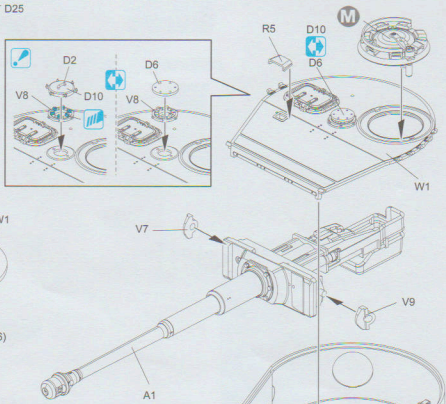
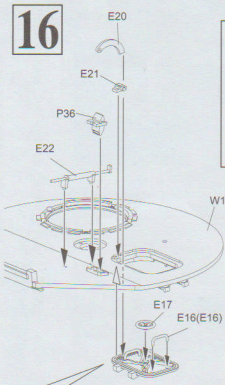
13**14****15****16****17**

18

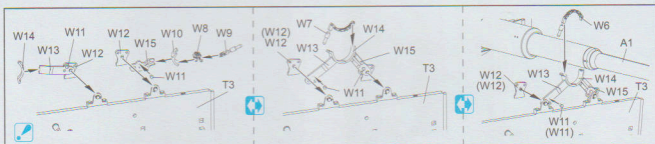
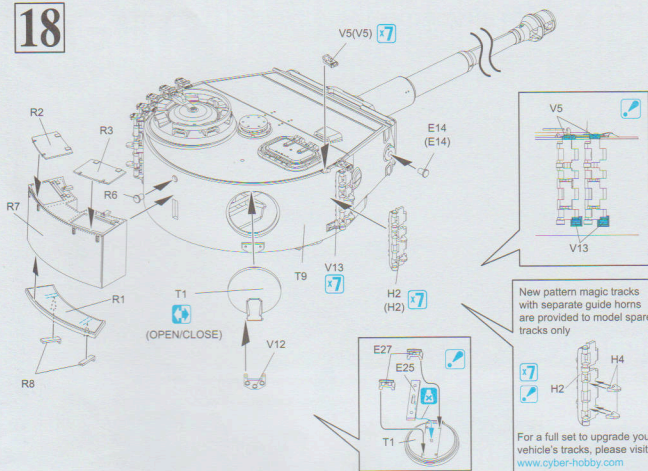

19

