

1

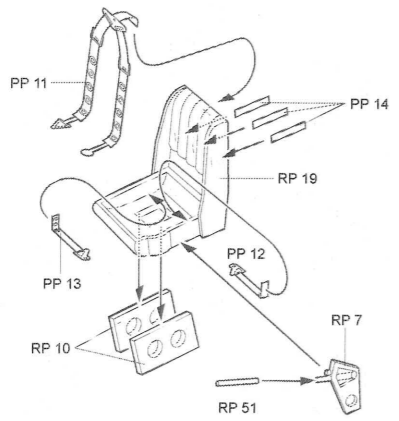

3

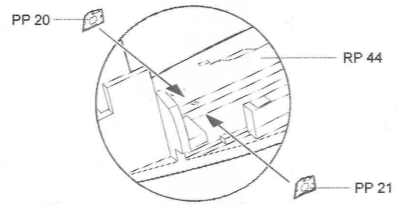

4

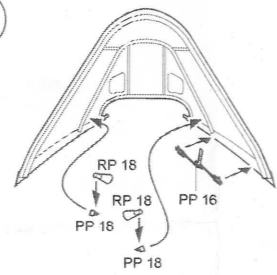

2

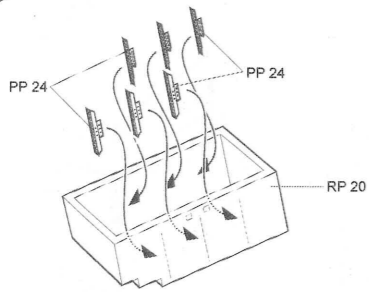

5 2X

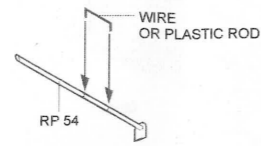

6

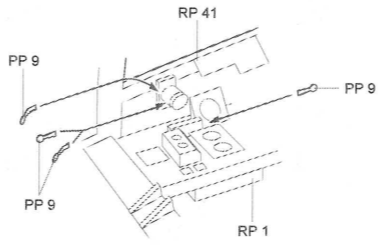

7

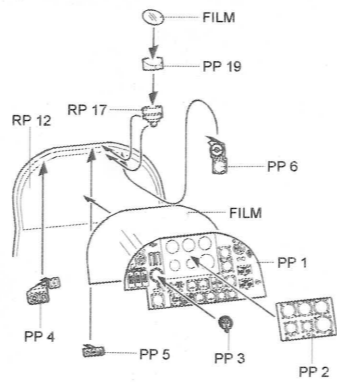

8

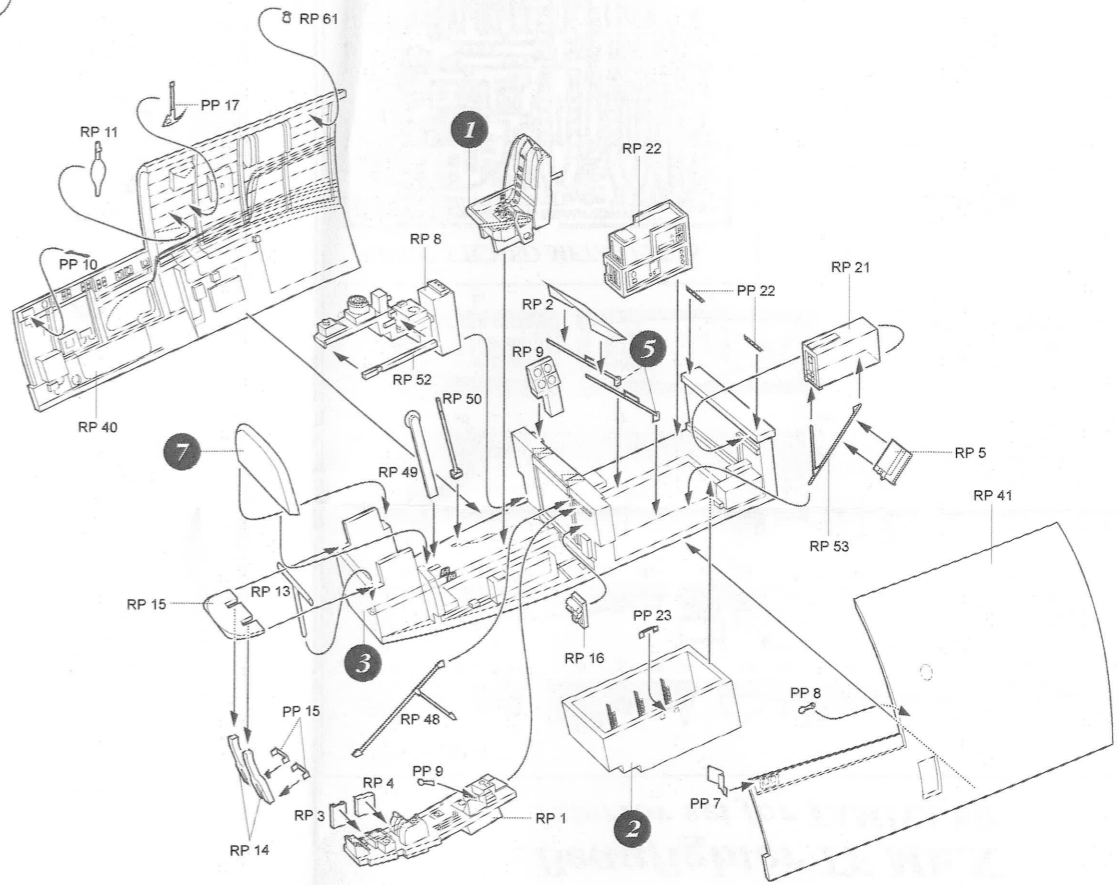

Warning: Thinning of the plastic parts and dry-fitting of the assembly is needed!
 Upozornění: Některé plastové díly stavebnice! Před lepením zkontrolujte dopasování dílů!