

**1 CUT**

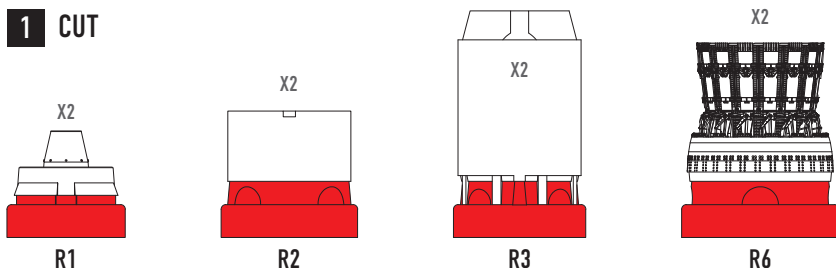

**2 X2**

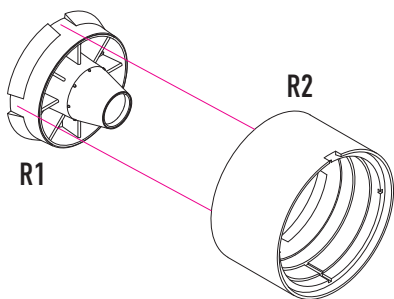

**3 X2**

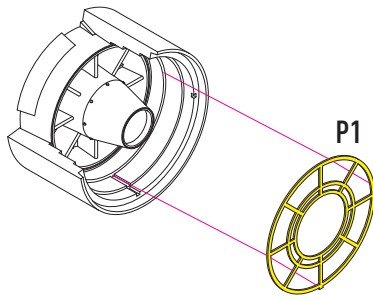

**4 X2**

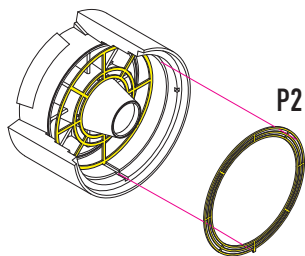

**5 X2**

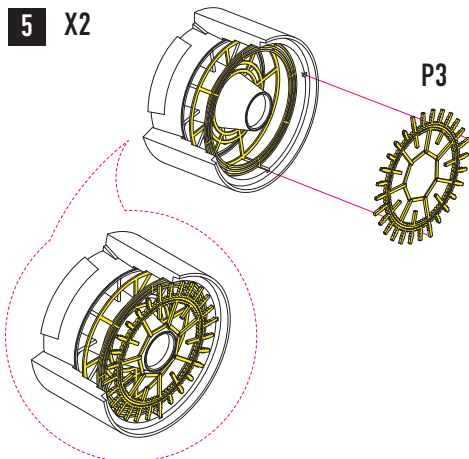

**6** X2

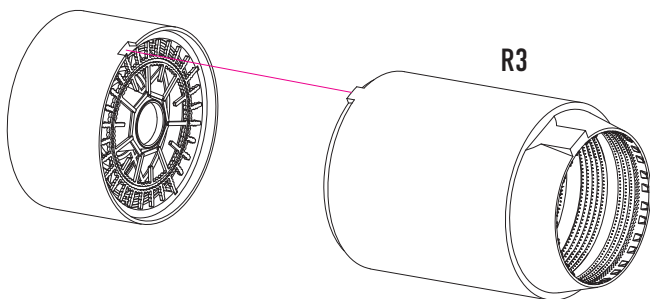

**7** X2

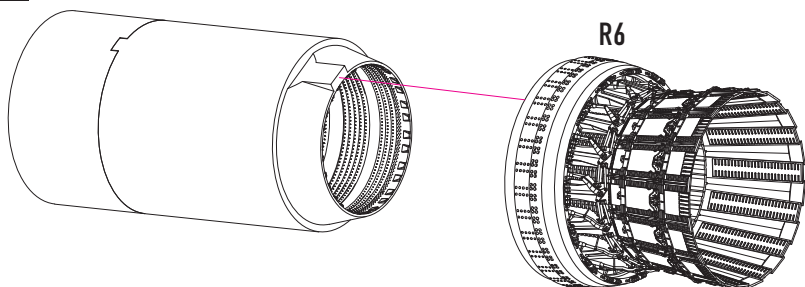

**8** X2

