

1/35 MILITARY MINIATURE VEHICLE UPGRADE SERIES PEA415









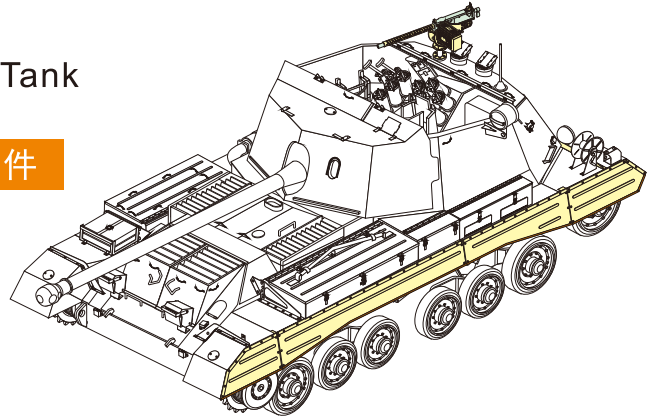
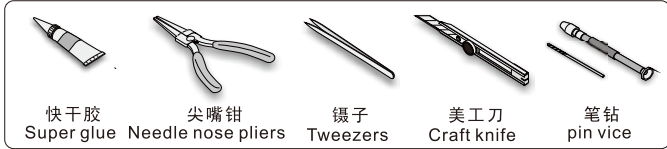

WWII British Archer Self-Propelled Anti-Tank Gun additional parts

二战英国 弓箭手 自行反坦克炮附加改造件

[For TAMIYA 35356]

■ 推荐使用工具 RECOMMENDED TOOLS



- 
 安装
install
- 
 折叠
bend
- A1**
 改造件零件编号
PE/resin part number
- B12**
 原零件编号
kit part number
- C22**
 被替换的原零件编号
replaced kit part number
- 
 另一侧相同制作
repeat on opposite side
- 
 切除
remove
- 
 打磨
grind off
- 
 弧度卷曲
radial bending
- 
 制作若干组
multiple assembly
- 
 选择安装
alternative
- 
 钻孔
drill
- 
 用胶棒制作
make from plastic rod

 用尖端在凹槽处冲压
use penpoint to press on the dent

蚀刻片零件内朝面向上
Put the part upside down
 用笔尖在凹槽处刺
Use penpoint to press on the dent

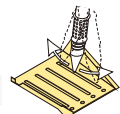
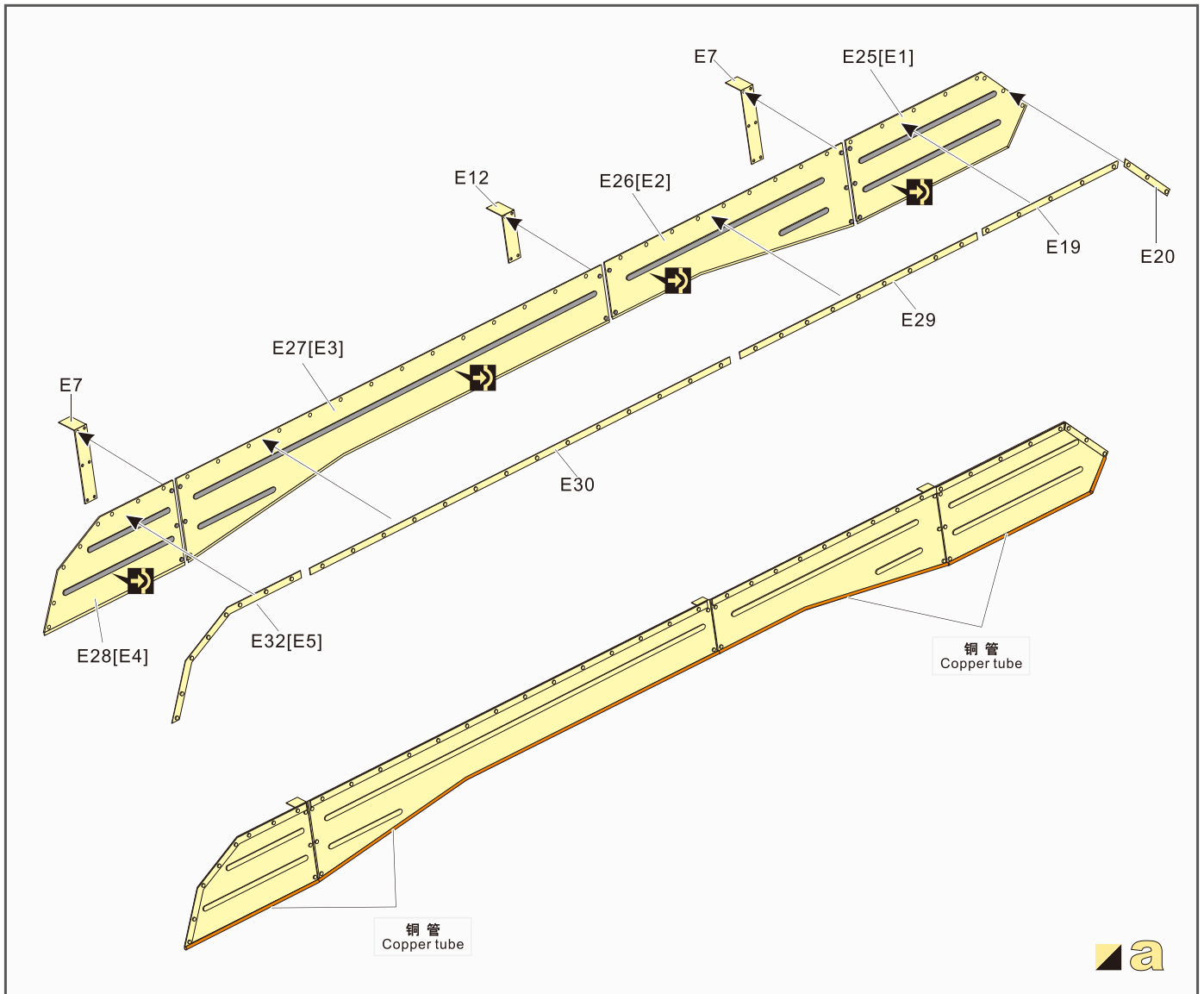
1/35 MILITARY MINIATURE VEHICLE UPGRADE SERIES PEA415

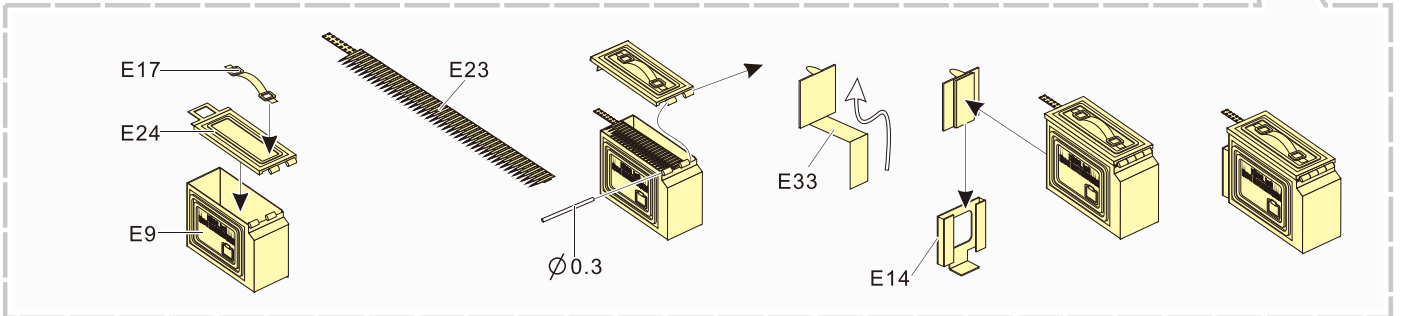
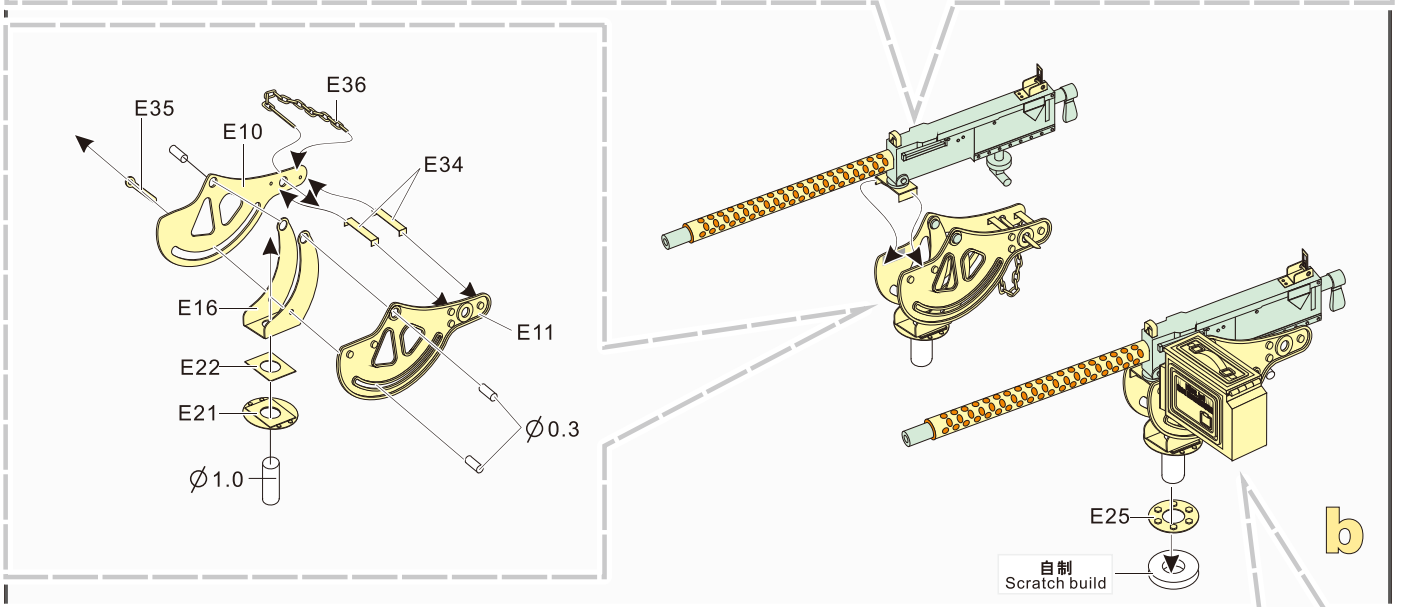
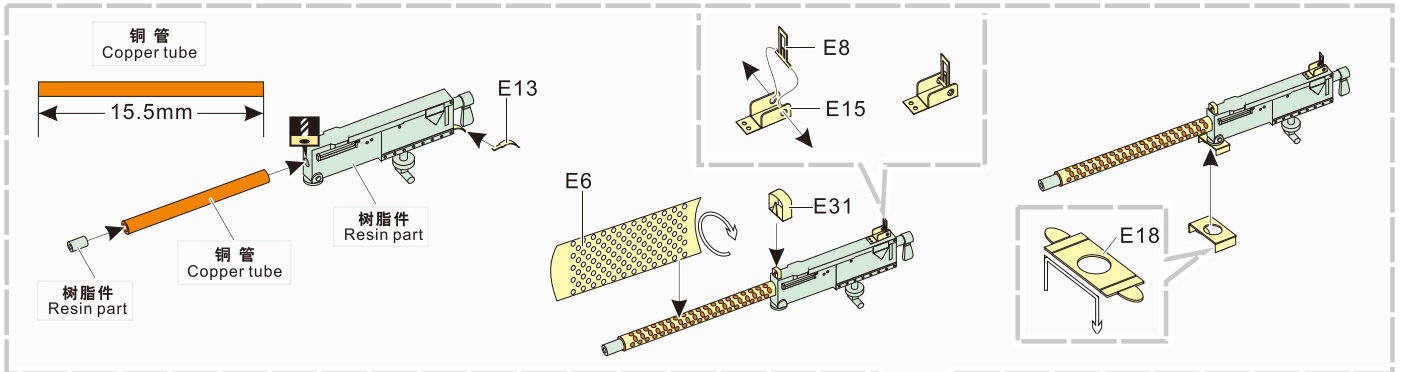

**VOYAGER
MODEL**



更多PEA 415样品照片参考请扫一扫
MORE PICTUER OF PEA 415
REFERENCE SCAN HERE

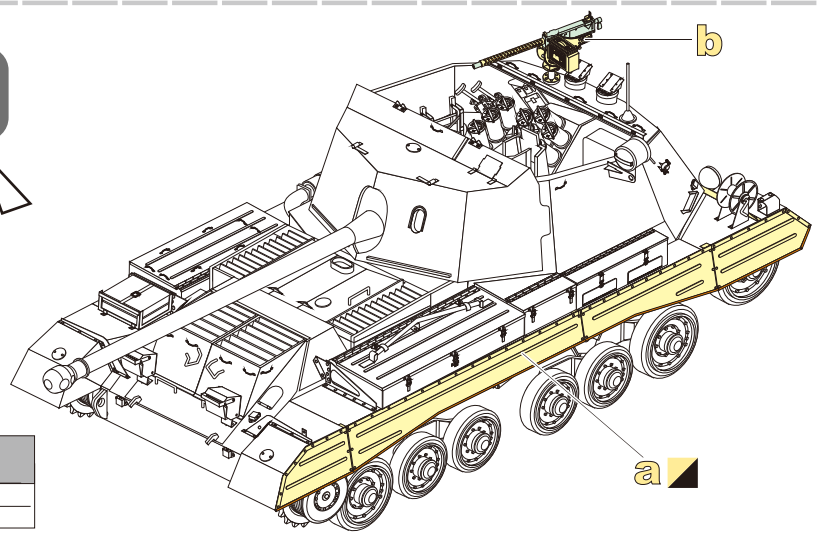

VOYAGERMODEL[®] 无微不至 悦享享受
The Best Upgrade Solution

Recommended item

PE 35919	WWII British Archer Self-Propelled Anti-Tank Gun
VBS 0521	WWII British 17pdr Gun Barrel set