

1/35 MILITARY MINIATURE VEHICLE UPGRADE SERIES PEA406







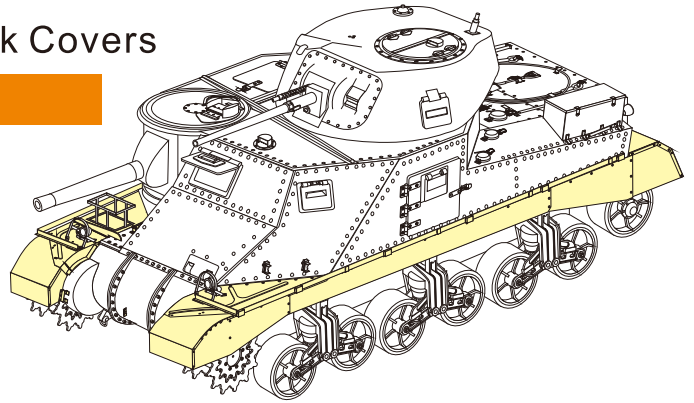
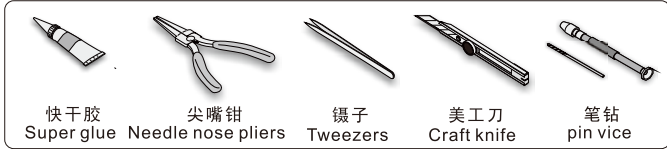

WWII British Grant Medium Tank Track Covers

二战英国M3 格兰特 中型坦克裙板改造件

[For TAKOM 2086]

■ 推荐使用工具 RECOMMENDED TOOLS



- 
安装
install
- 
折叠
bend
- A1**
改造件零件编号
PE/resin part number
- B12**
原零件编号
kit part number
- C22**
被替换的原零件编号
replaced kit part number
- 
 另一侧相同制作
repeat on opposite side
- 
切除
remove
- 
打磨
grind off
- 
弧度卷曲
radial bending
- x2**
制作若干组
multiple assembly
- 
选择安装
alternative
- 
钻孔
drill
- 
用胶棒制作
make from plastic rod

 用尖端在凹槽处冲压
use penpoint to press on the dent

蚀刻片零件内侧面向上
Put the part upside down
用笔尖在凹槽处划
Use penpoint to press on the dent

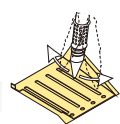
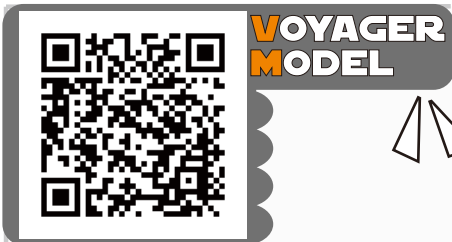
更多PEA 406样品照片参考请扫一扫
MORE PICTUER OF PEA 406
REFERENCE SCAN HERE

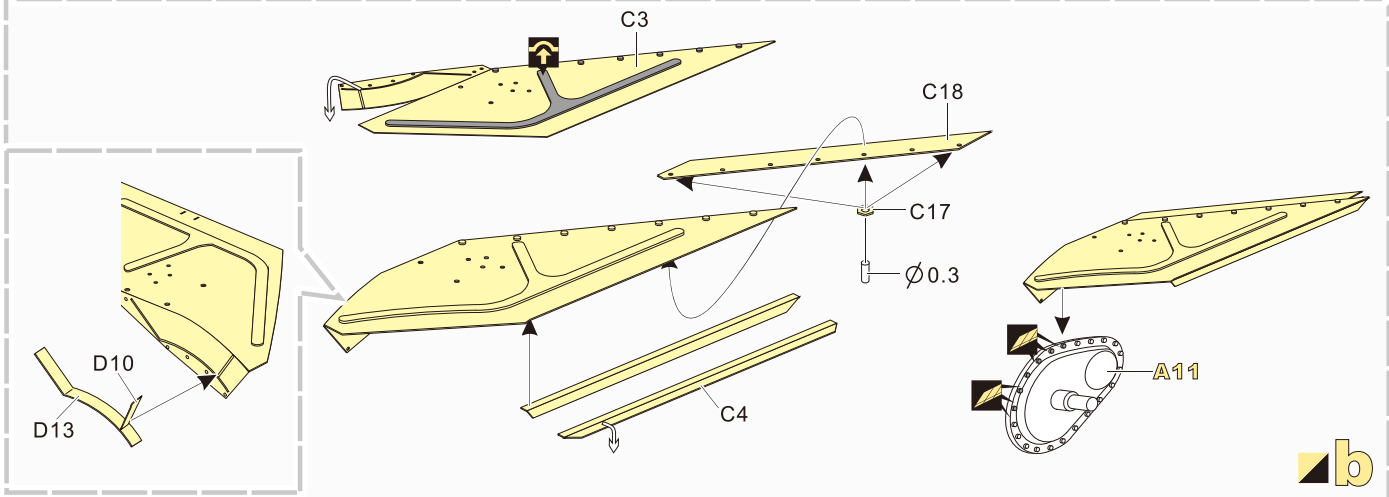
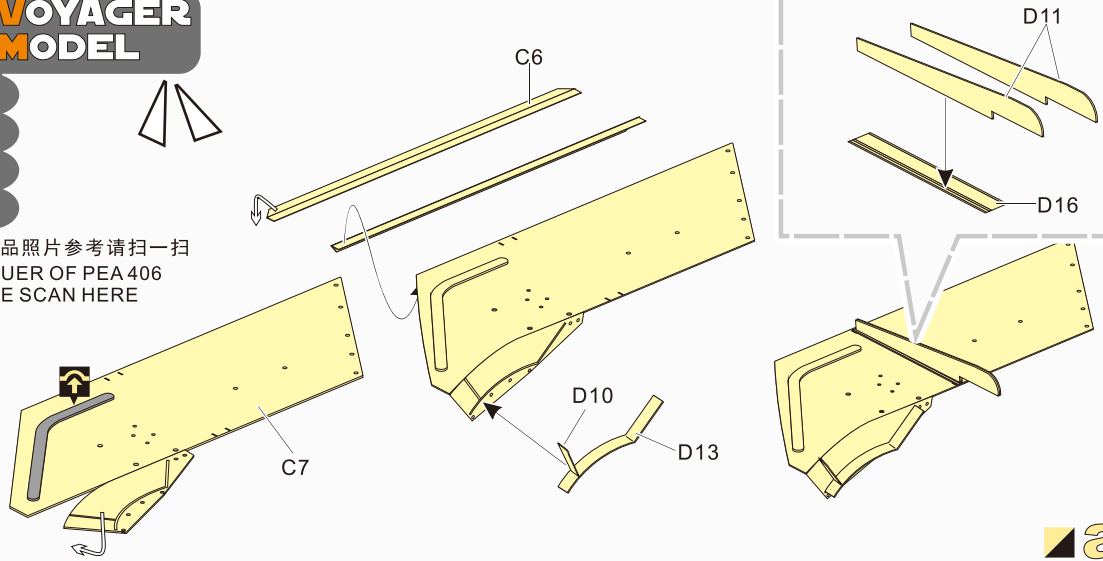

1/35 MILITARY MINIATURE VEHICLE UPGRADE SERIES PEA406

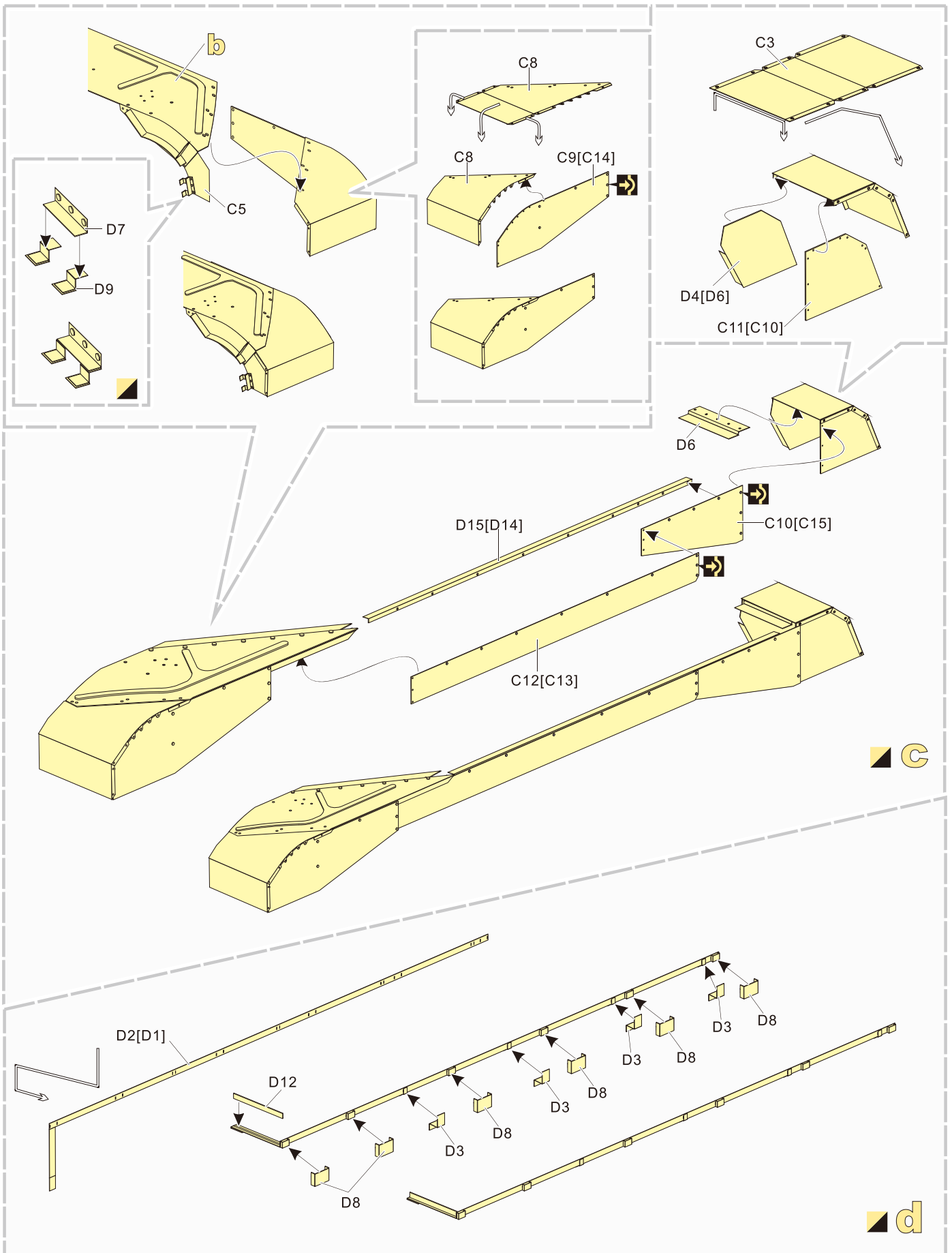

1/35 MILITARY MINIATURE VEHICLE UPGRADE SERIES PEA406

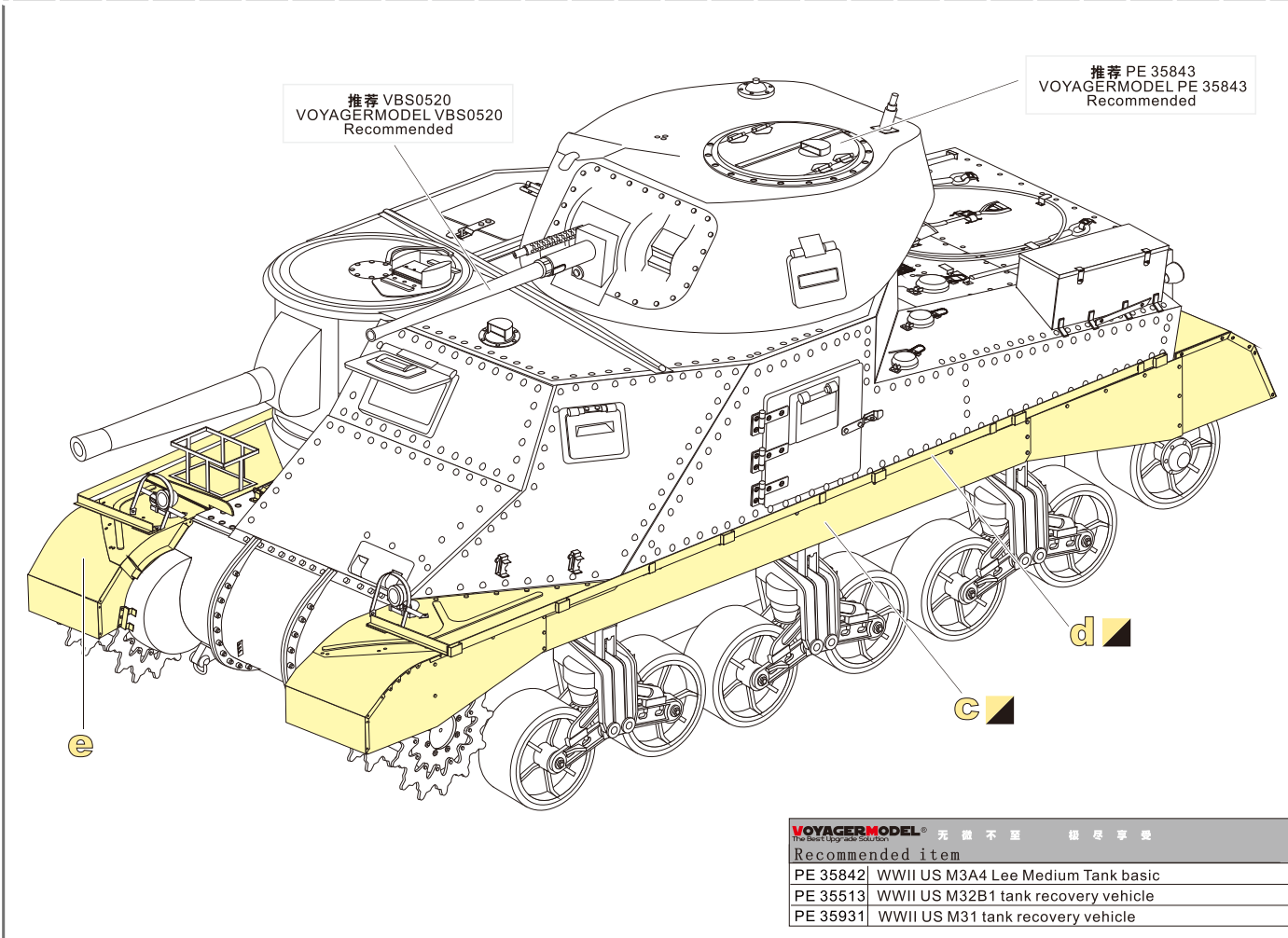
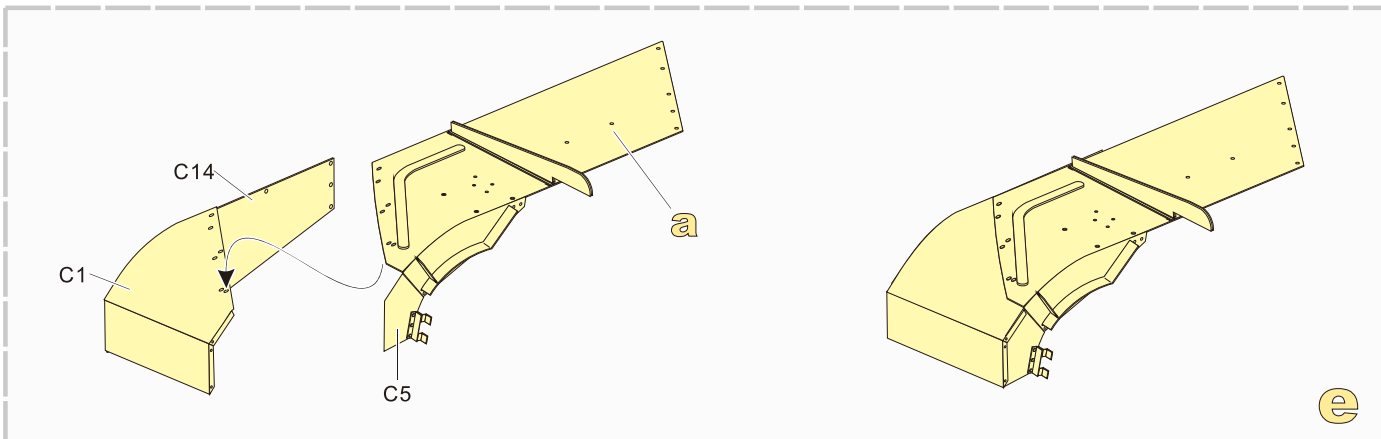

VOYAGERMODEL® 无微不至 极致享受
The Best Upgrade Solution

Recommended item	
PE 35842	WWII US M3A4 Lee Medium Tank basic
PE 35513	WWII US M32B1 tank recovery vehicle
PE 35931	WWII US M31 tank recovery vehicle

