

## Albatros D.V/D.Va

1/32 Scale

Johannisthal based Albatros Flugzeugwerke GmbH were responsible for some of the most graceful and effective fighters of the Great War. Their twin gun, semi-monocoque plywood fuselage Albatros D.1, powered by a 160hp Daimler Mercedes D.III engine, arrived at the front in September 1916 and achieved instant air superiority over its main opposition of Nieuport 11 and DH.2 fighters. Followed immediately by the slightly improved D.II and in December 1916 by the much improved D.III, with its V strutted sesquiplane wing greatly influenced by the successful Nieuport fighters. The D.III was more maneuverable than the D.II and its single spar lower half wing afforded greater visibility for the pilot but was also the cause of numerous, frequently fatal, structural failures. Despite much effort this problem was never fully resolved. Nevertheless the D.III remained in production well into late 1917.

Even as the excellent D.III went into production plans were underway for its successor, the Albatros D.V. Retaining the wings of the D.III but with aileron controls routed through the upper wing and with a redesigned fuselage completely oval in section, the D.V was arguably the best looking of all Albatros designs. Unfortunately the D.V inherited the lower wing structural failure problem of the D.III and turned out to not be any real improvement over it performance wise either. Despite this, the Albatros D.V and the D.Va (with aileron controls cables reverted to D.III configuration), were manufactured in greater numbers than any previous German fighter of the war (only surpassed later by the Fokker D.VII, of which Albatros manufactured the great majority).

The Albatros D.V weighed 620kg empty when production commenced in April 1917 but, following strengthening, the empty weight had increased to 680kg before production of the D.Va started in August 1917. While Johannisthal built D.Va remained 680kg throughout production, those ordered from Ostdeutsche Albatros Werke (OAW) in September-October 1917 weighed in at 717kg empty, almost 100kg heavier than the initial D.V. When the Albatros D.V started appearing at the front in May 1917 it was effectively outclassed by the improved SE.5a, Sopwith Camel and SPAD fighters being fielded by the allies at the time. Even after the introduction of the superb Fokker D.VII the Albatros D.V and D.Va could still be found equipping front line Jastas, although most had been relegated to training or home defense duties by the time of the Armistice. Note that these instructions illustrate parts to build Johannisthal built Albatros D.V & D.Va and Ostdeutsche Albatros Werke (OAW) built D.Va. Please make sure you take note of the different parts required for your chosen decal scheme. Any history of this important aircraft here is of necessity very brief, therefore we encourage you to seek out any, or all, of the reference books mentioned below for a more thorough understanding.

WW1 colour schemes are contentious at the best of times and we have done our best to provide what we consider to be accurate painting information for this model. The colourful unit and personal markings applied to the various German fighters of the Great War have attracted more than their fair share of debate over the years and, while we have been as meticulous as we could be, I'm sure some will not find our choices to their liking. Albatros D.V/D.Va fuselages were usually clear varnished resulting in a yellowish plywood colour. The fabric covered wings and tailplane were finished in either of 2 ways, painted (with medium grey green & mauve or dark grey green & lilac on top with light blue below) or covered in pre-printed lozenge camouflage fabric, some of which was almost certainly overpainted with a transparent (brown?) glaze to tone down the vibrant colours. Metal fittings were painted in pale grey-green, as was much of the engine bay. Exterior metal panels and fittings were usually painted in this same pale grey-green colour although some late production D.Va were finished in a darker grey-green colour. There was considerable freedom for German units to apply their own colour schemes to their aircraft with some using drab camouflage paints, usually applied with a 'loofah' type sponge, while others preferred highly visible colours to aid identification at a distance. Additionally individual pilot's markings were also applied in a fashion dictated by the unit commander.

Richard Alexander 2019

<b>Wingspan:</b>	<b>Length:</b>	<b>Max Weight:</b>	<b>Max Speed:</b>
9.00m (29' 6")	7.33m (24' 0.5")	755kg - 937kg	170kph (106mph)
<b>No. Manufactured:</b>	<b>Production:</b>	<b>Armament:</b>	
D.V 900/D.Va 1662	April 1917 - early 1918	2x 7.92mm LMG 08/15 'Spandau'	
<b>Ceiling:</b>	<b>Engine:</b>		
6250m (20500')	160-180-200hp Daimler-Mercedes D.III/IIIa/IIIaü		

### References:

Windsock Datafile 3 Albatros D.V, Ray Rimell, 1987 - Albatros Fighters Windsock Datafile Special, Ray Rimell, 1991  
 Squadron Signal Albatros Fighters in Action, John F Connors, 1981 - Australian War Memorial Museum, Canberra, Australia  
 The Vintage Aviator LTD. - 1914-18 Aviation Heritage Trust - Private Collections



# Albatros D.V/D.Va

1/32 Scale

- Warning:** Choking hazard. Keep small parts and plastic bags away from children. Use glue and paint in a well ventilated area. Always wear protective eyewear when cutting and a protective mask when painting, gluing and sanding. Do not breathe dust from polyurethane resin parts (if included). Beware of sharp edges on metal parts.
- Assembly:** **Read all the instructions carefully before starting assembly.** Use glue intended for plastic models. Assemble metal and resin parts (if included) using Cyanoacrylate (CA) or epoxy glue. Before assembly select a marking option and note optional parts required in instructions.
- Rigging:** If installing rigging please drill out all location holes with a 0.5mm drill bit to a depth of at least 1mm. To make rigging as simple as possible we recommend using stretchy elastic type material like 'EZ Line' etc and not trying to replicate any turnbuckles.
- Painting:** Only use paints **designed and suitable** for plastic model kitsets.
- Decals:** Cut out each decal as required. Soak in warm water for 15 seconds. Slide off backing paper onto **gloss painted surface of model (not just clear coated plastic)**. For large decals it is helpful to apply a drop of water to the area they are being applied to. This will make it easier to maneuver them into the correct position.

**Hints & Tips:** Please visit our website for additional photos, hints and tips to assist you in getting the best result from your Wingnut Wings model.

<b>1</b> Construction Step	Choose	Attention	Remove
<b>A1</b> Part Number	Do Not Cement	Option	Drill
<b>5</b> Decal	Cement For Metal	Other Side	Paint Colour
<b>P1</b> Photo Etch Part			

	All colours		Humbrol	Federal Standard
a	Brass	X31	54	
b	Gun Metal	X10	27004	
c	Aluminium	XF16	27001	
d	Black - semi gloss	X18	85	
e	Dark Wood* - gloss	XF68	98	30340
f	Leather - semi gloss	XF52	62	30219
g	Light Blue - gloss	XF2(x10) + XF18(x1)	130(x10) + 96(x1)	25550
h	Chrome Yellow - semi gloss	XF3(x10) + X6(x1)	24	33637
i	Light Grey - matt	XF19	64	36463
j	Interior Grey Green	XF76	240	24424
k	Red - semi gloss	X7	19	31350
l	Rust - matt	XF9	113	20045
m	White - semi gloss	XF2	130	
n	Light Wood* - gloss	XF59	93	30475
o	Mauve - semi gloss	X16(x2) + XF52(x1)	68(x5) + 29(x1)	
p	Steel	XF56	27003	
q	Clear Doped Linen - semi gloss	XF55	148	26360
r	Camouflage Green - matt	XF65	116	34159
s	Copper	XF6	12	
t	Green - gloss	X28	208	14193
u	Silver	XF16(x2) + XF19(x1)	11(x1) + 34(x1)	
v	Rubber - matt	XF69	66	35042
w	Medium Grey Green - semi gloss	XF71	78	34227
x	Brown Glaze - semi gloss	X22(x5) + XF52(x1)	135(x5) + 29(x1)	
y	Lilac - semi gloss	X16(x1) + XF52(x1) + XF2(x2)	-	27144
z	Dark Grey Green - semi gloss	XF65	116	34159

**Note:** Apply clear varnish to achieve the desired gloss or semi-gloss finish. \*See our website hints and tips for painting wood.



D.V

D.Va & D.Va (OAW)

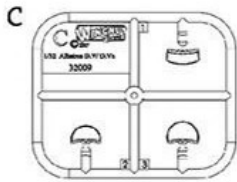
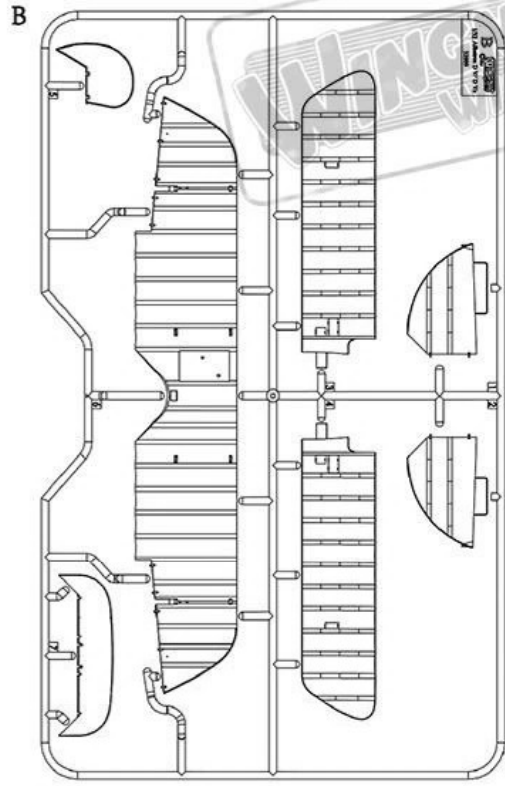
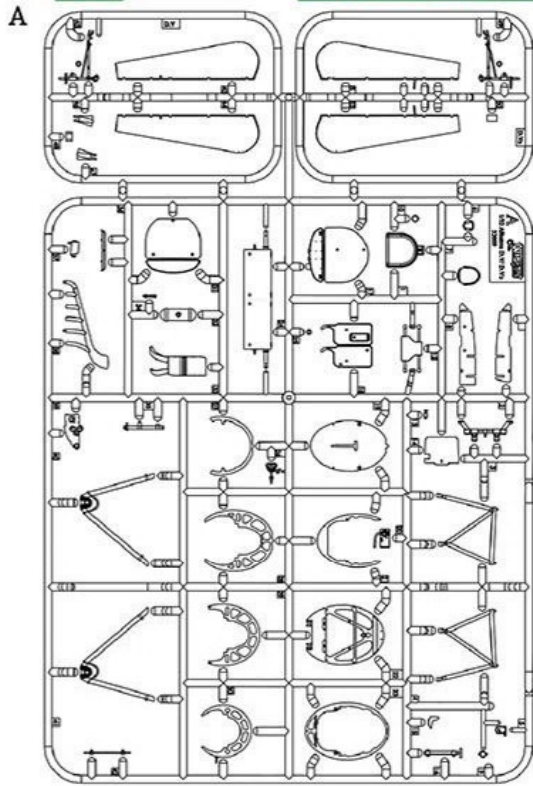

D x2

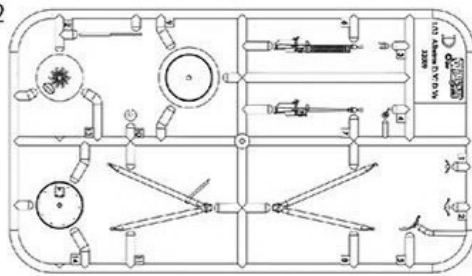

■ = Not Used

Photo Etch

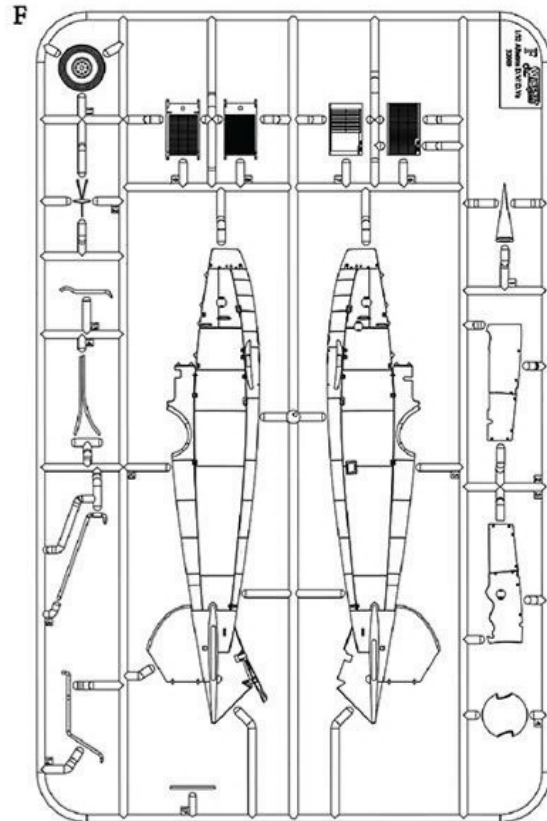
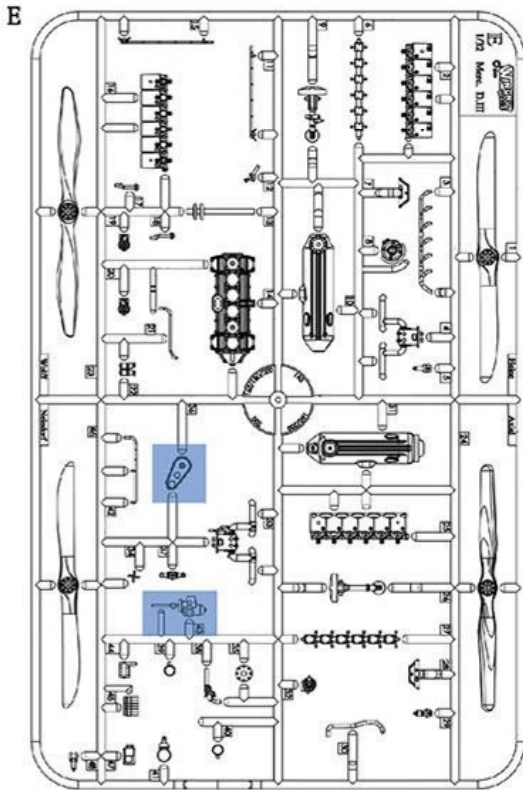
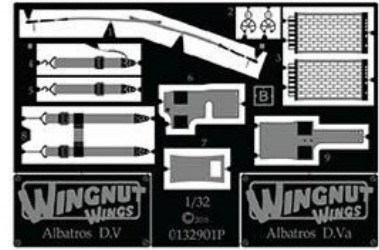

+ version specific decals



# 1 COCKPIT

**!** Please see our website for hints and tips on painting realistic wood colours.

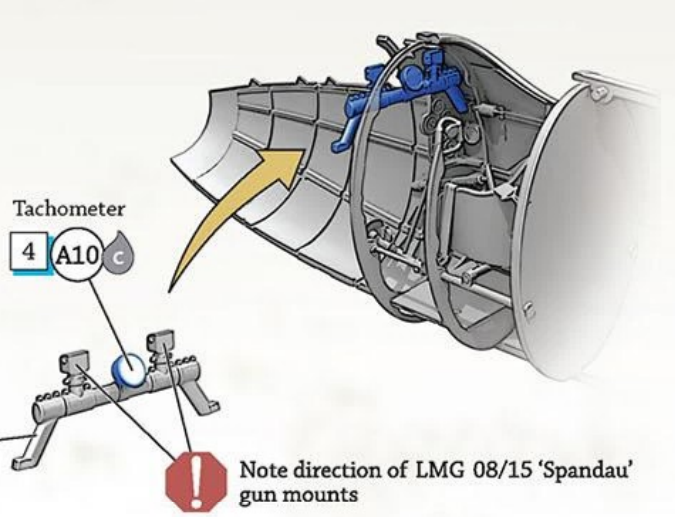
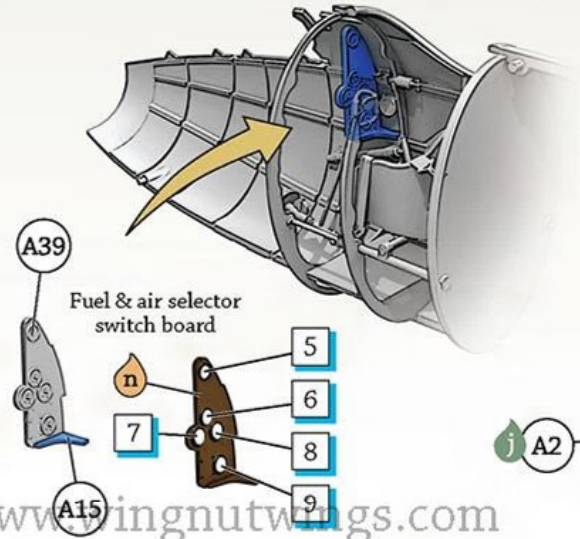
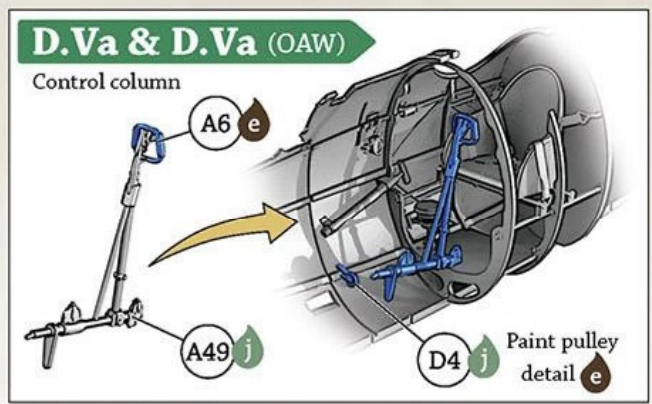
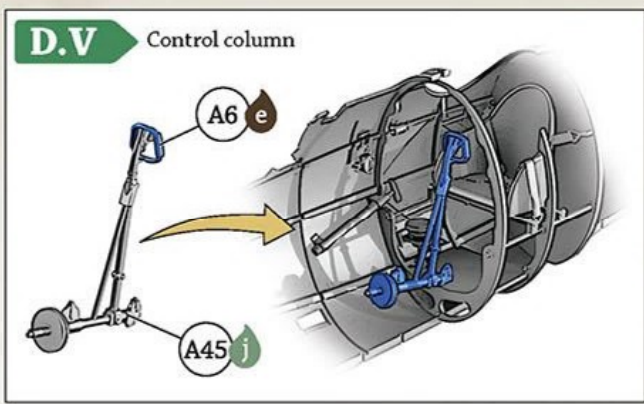
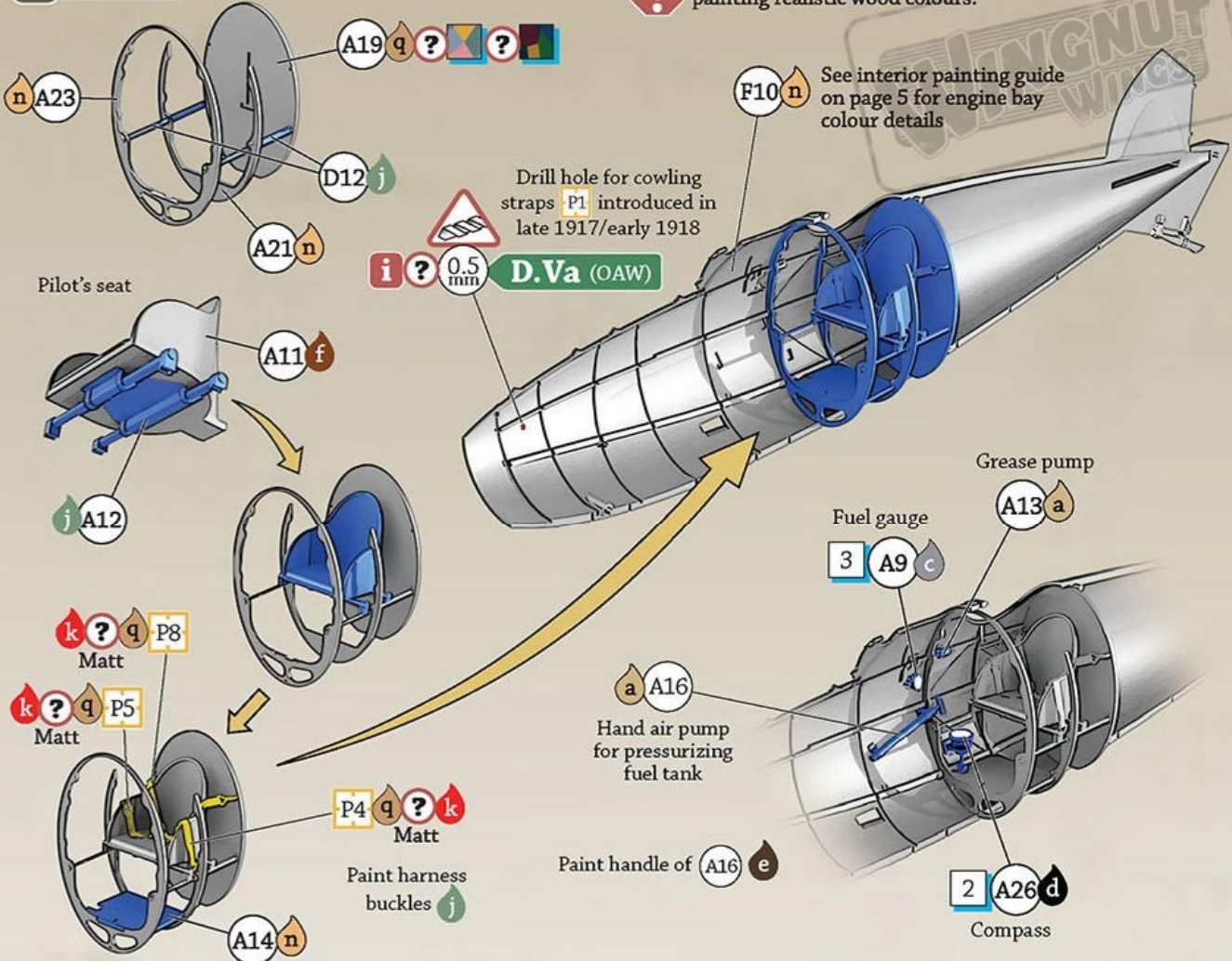



**2 COCKPIT continued**

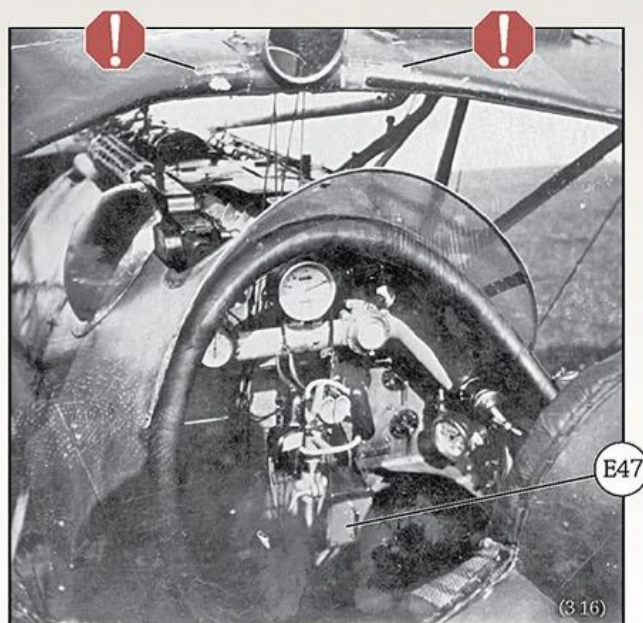
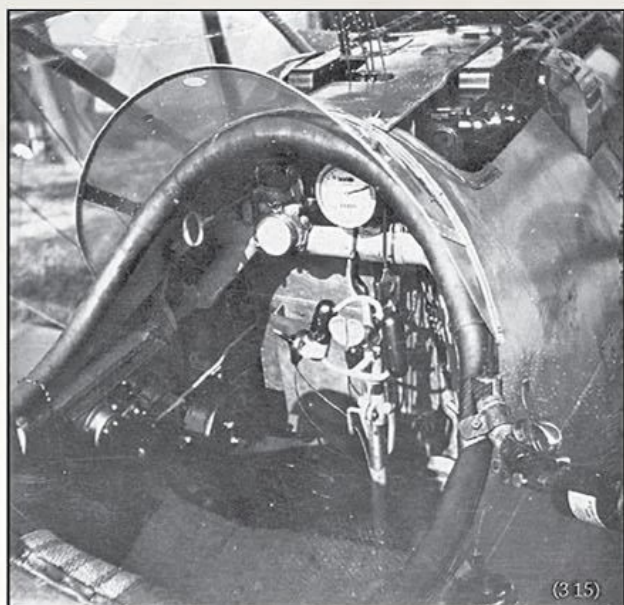
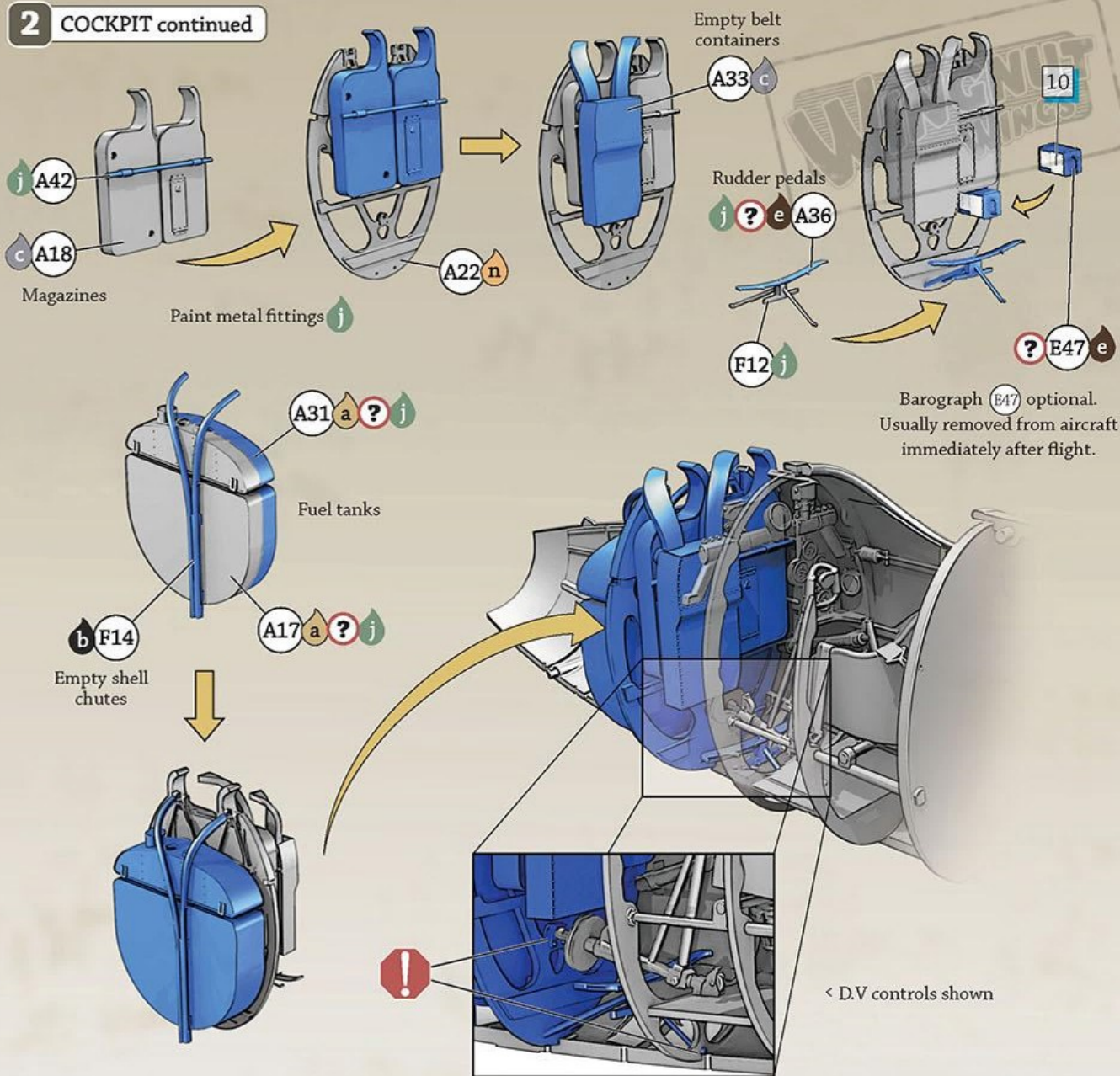

Cockpit details from a Royal Prussian Jasta 31 Albatros D.V. Note the pilot's goggles dangling from the all important tachometer attached to the center of the LMG 08/18 'Spandau' mount, with an altimeter to the left and clock to the right. Also note the barograph (E47) suspended below the instrument board, mirror (E4), D.V specific headrest (F1) & aileron control cables, the Eisfeld flare gun attached to the right of the cockpit and the data plates attached to the rear of the top wing cut out.



(0443-069)



Factory fresh very early production Albatros D.V 1146/17 is from the 1st production order for 200 D.V placed in April 1917 (numbers 1000/17 to 1199/17). Note the large D.V headrest, empty ammunition belt chute fairing (A7), aileron control horns & fairings, 2 line weight table painted on the side of the fuselage under the cockpit and lack of cowling retaining straps (P1). The fuselage is varnished plywood, the rudder is unbleached doped linen while the wings and tailplane are finished in medium grey green (w/o) mauve or dark grey green (z/y) lilac camouflage paint.

(11)



Albatros D.Va with the silver fuselage unit colour of Royal Bavarian Jasta 34b and Robert Ritter von Greim's personal marking of 2 red bands. Although the serial number is unconfirmed this aircraft appears to be from the 1st production order for 262 D.Va placed in August 1917 (numbers 5165/17 to 5426/17). Note the D.Va aileron control cables visible behind each interplane 'V' strut, which do not feature the additional wing bracing brackets. The wings and tailplane are covered in 5 colour lozenge fabric.

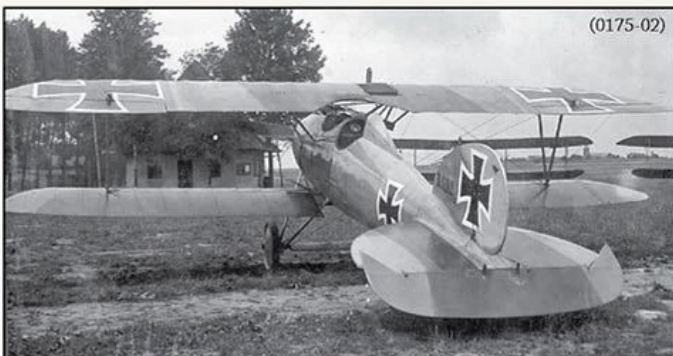

(0175-02)



(36)

160hp D.III

Factory fresh very early production Albatros D.V 1192/17 is from the 1st production order and was photographed here in July 1917. Note the 160hp Daimler-Mercedes D.III engine, headrest, empty ammunition belt chute fairing (A7) and the assembly & rigging instructions doped to the port side of the fuselage.



### 3 DAIMLER-MERCEDES 160hp D.III ENGINE

! 160hp, 180hp & 200hp engines could be swapped between airframes.

**D.V**

1000/17 to 1199/17  
1962/17 to 2361/17  
4403/17 to circa 4470/17

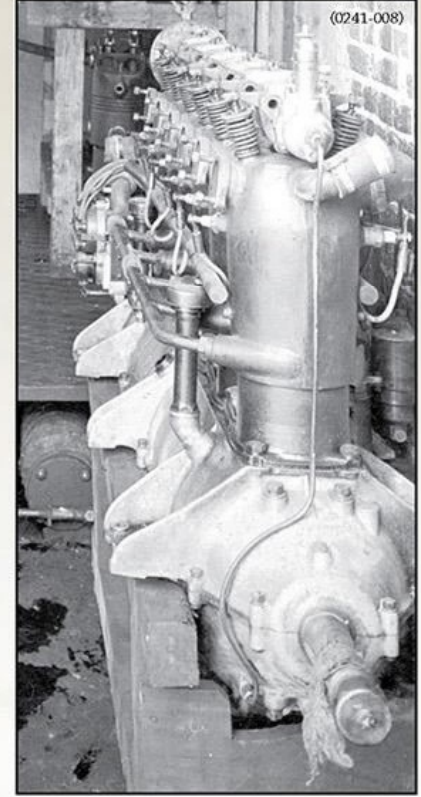
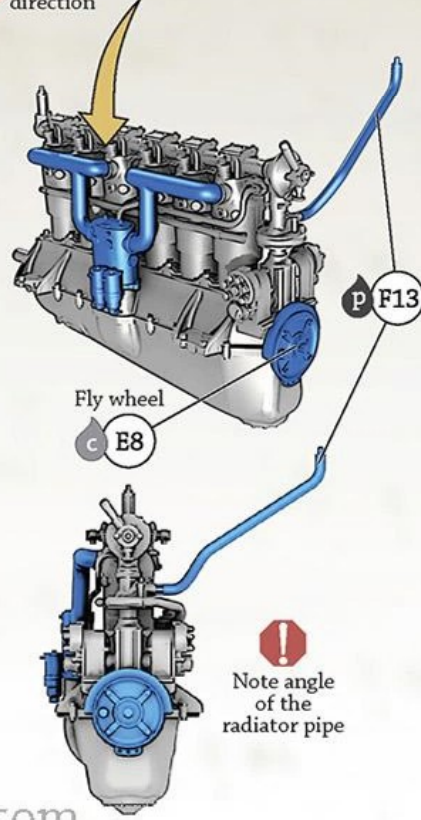
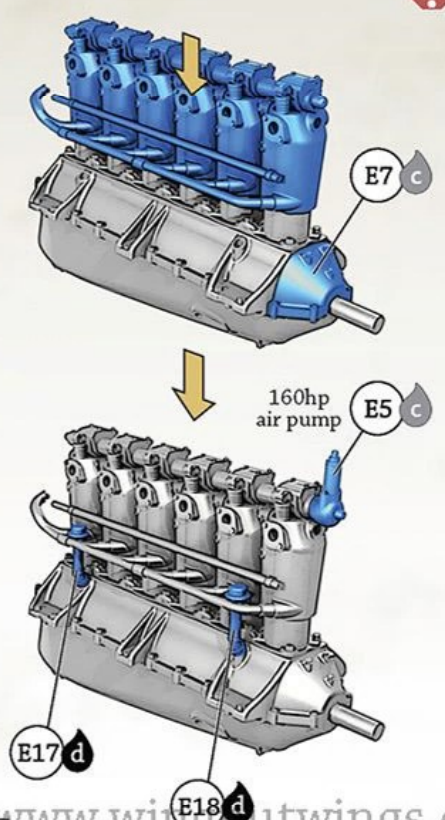
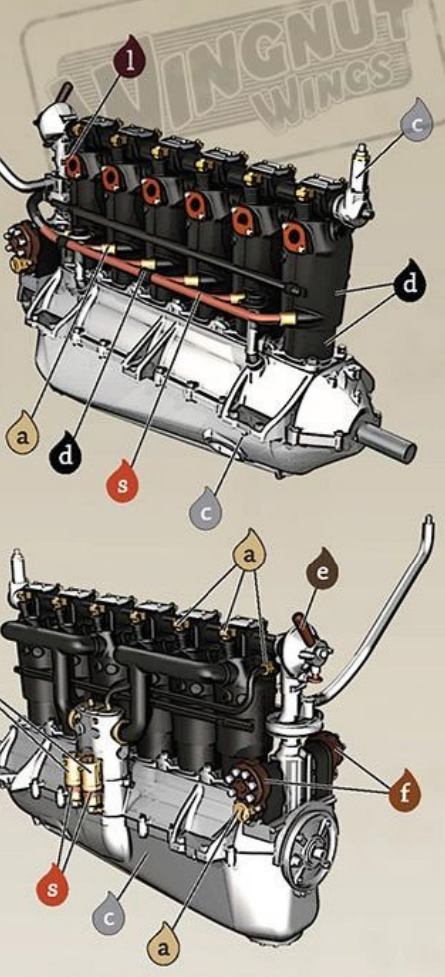
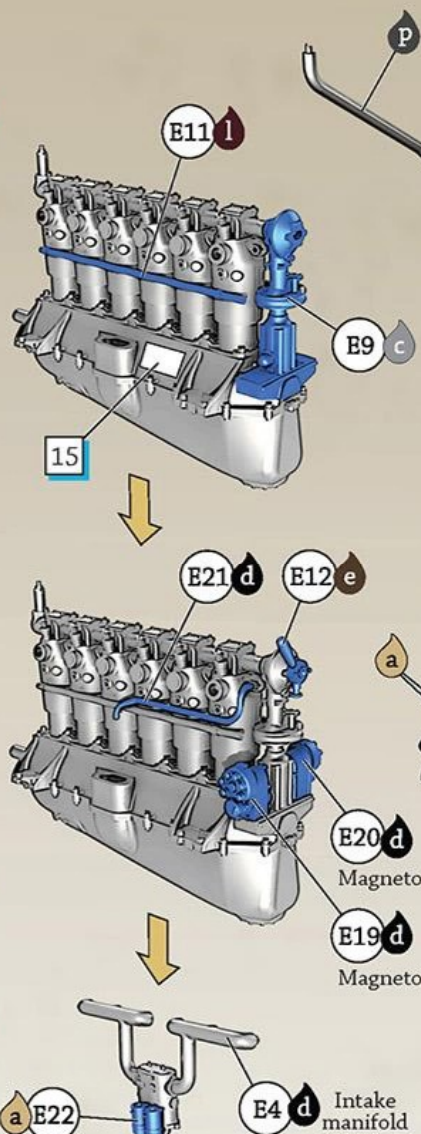
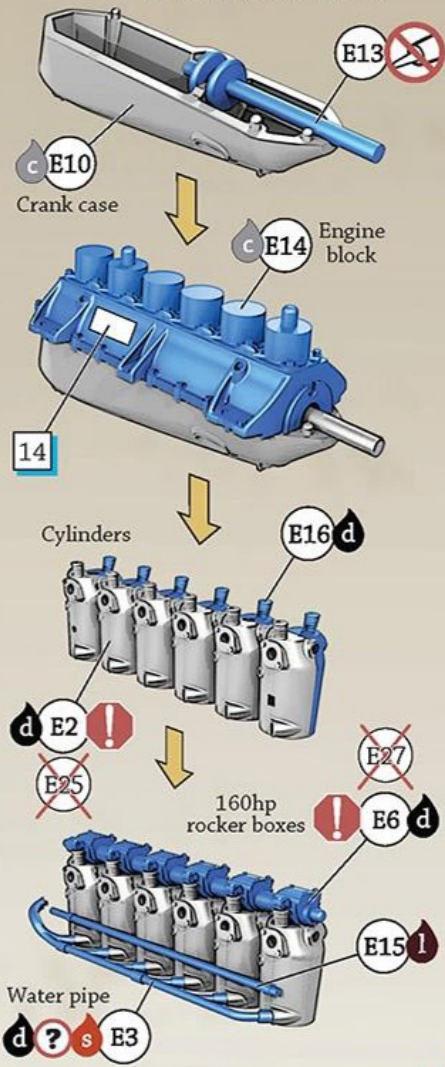

160hp Daimler-Mercedes D.III engine under going maintenance. This is the most common type of engine fitted in the Albatros D.V. Note the small cylindrical air pump (E5) at the front and on the right side of the engine the exposed water pipe (E3).



# 4 DAIMLER-MERCEDES 180hp D.IIIa & 200hp D.IIIaü ENGINE

**D.V** Circa 4470/17 to 4702/17  
(4665/17 & 4675/17 = 160hp)

**D.Va & D.Va (OAW)**

**!** 160hp, 180hp & 200hp engines could be swapped between airframes.

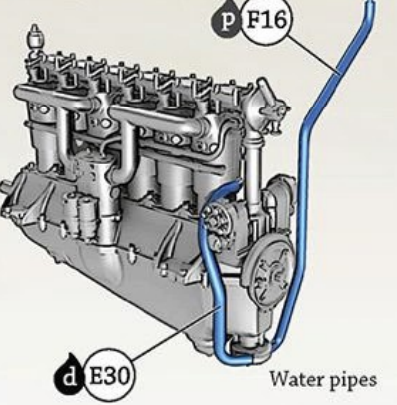
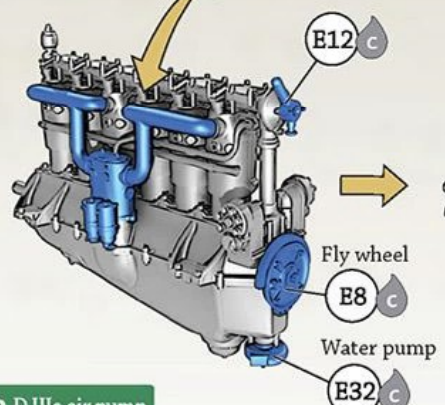
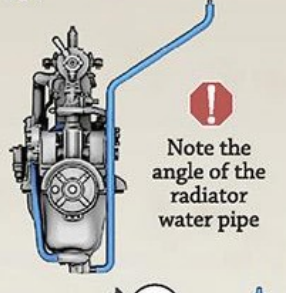
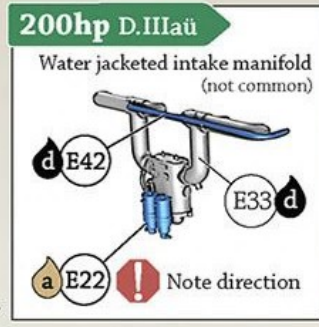
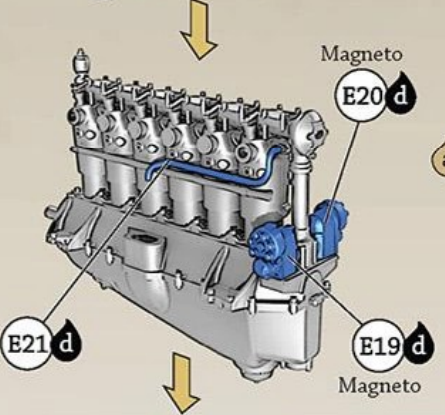
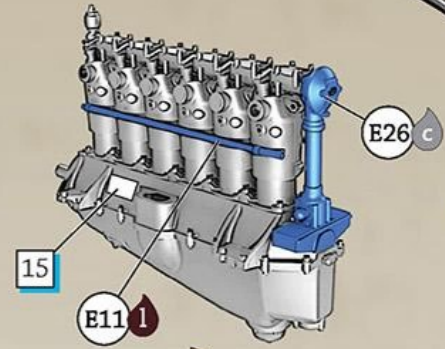
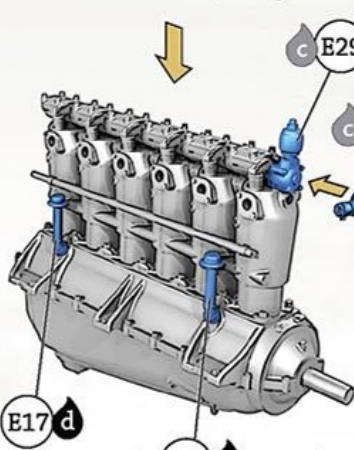
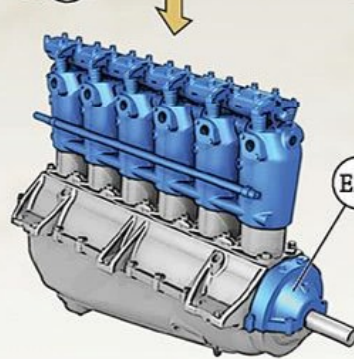
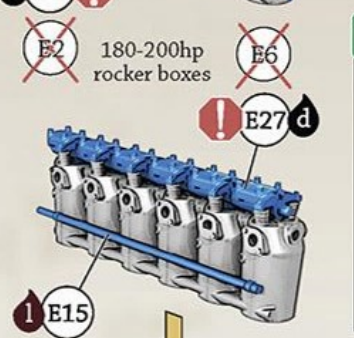
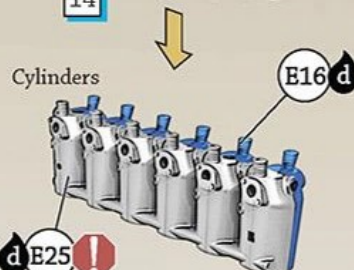
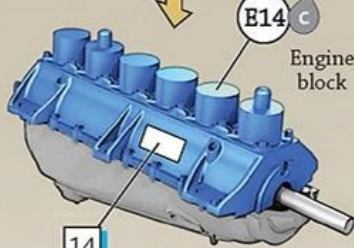
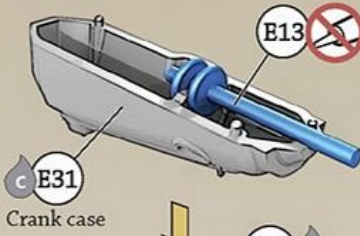

**180hp D.IIIa air pump** (E29)

**200hp D.IIIaü air pump** (E37) (not common)

The 180hp Daimler-Mercedes D.IIIa of this crashed Royal Prussian Jasta 62 Albatros D.Va has the water jacketed intake manifold more commonly associated with the 200hp D.IIIaü engine.

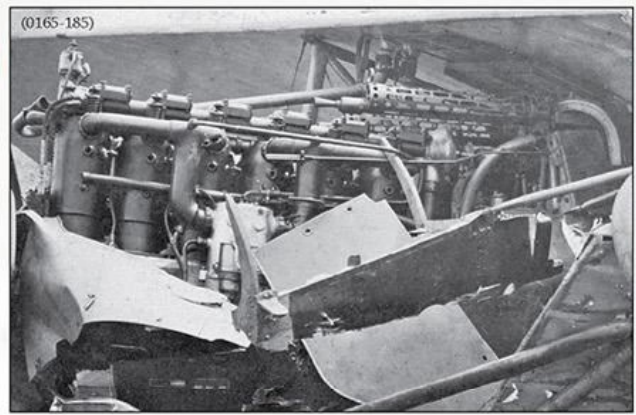





(0810-016)

Long serving Albatros D.V 2359/17 is from the 2nd production order for 400 D.V placed in May 1917 (numbers 1962/17 – 2361/17) and was serving with Royal Bavarian Jasta 23b by the time Otto Hohmuth was captured on 6 March 1918. By this time the original 160hp Daimler-Mercedes D.III engine had been replaced by the 180hp Daimler-Mercedes D.IIIa seen here, the original 'V' struts (D8) had been reinforced with braces (D11) and had engine cowling retaining straps (P1) retrofitted. It is seen here after being repainted in RFC markings and having its armament removed. An anemometer was fixed to the starboard 'V' strut but has been removed by its captors and replaced with a single pitot tube on the top wing.



(446)

Long serving Johannisthal built Albatros D.Va '76' in service with a Marine Feld Jasta in mid to late 1918. Note the 180hp Daimler-Mercedes D.IIIa engine with water jacketed intake manifold, modified 'post March 1918' balkenkreuz markings and the additional wing strut bracing brackets on the interplane 'V' struts. Also note the mottled camouflage finish on the engine cowlings and the bomb rack fitted under the fuselage for 12.5kg PuW bombs. The very pale rigging wires are unusual and have probably been painted light blue or white.

This Ostdeutsche Albatros Werke built Albatros D.Va (OAW) is from the final production order, but the 1st order placed with OAW, for 600 D.Va in September-October 1917 (numbers 6400/17 to 6999/17). The OAW factory distinguishing features visible in this photo are the fuselage lifting handle (F17) and wheel cover (D13). Photographic evidence available to us indicates that all OAW built D.Va left the factory covered with lozenge fabric and powered by the 180hp Daimler-Mercedes D.IIIa engine. Note the 'post April 1918' style of balkenkreuz markings.

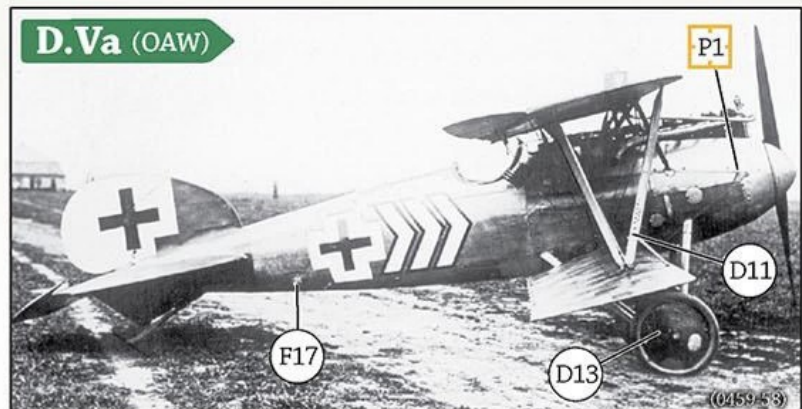

(0459-53)



## 5 ENGINE BAY

Paint bulkheads as per interior painting guide on page 5

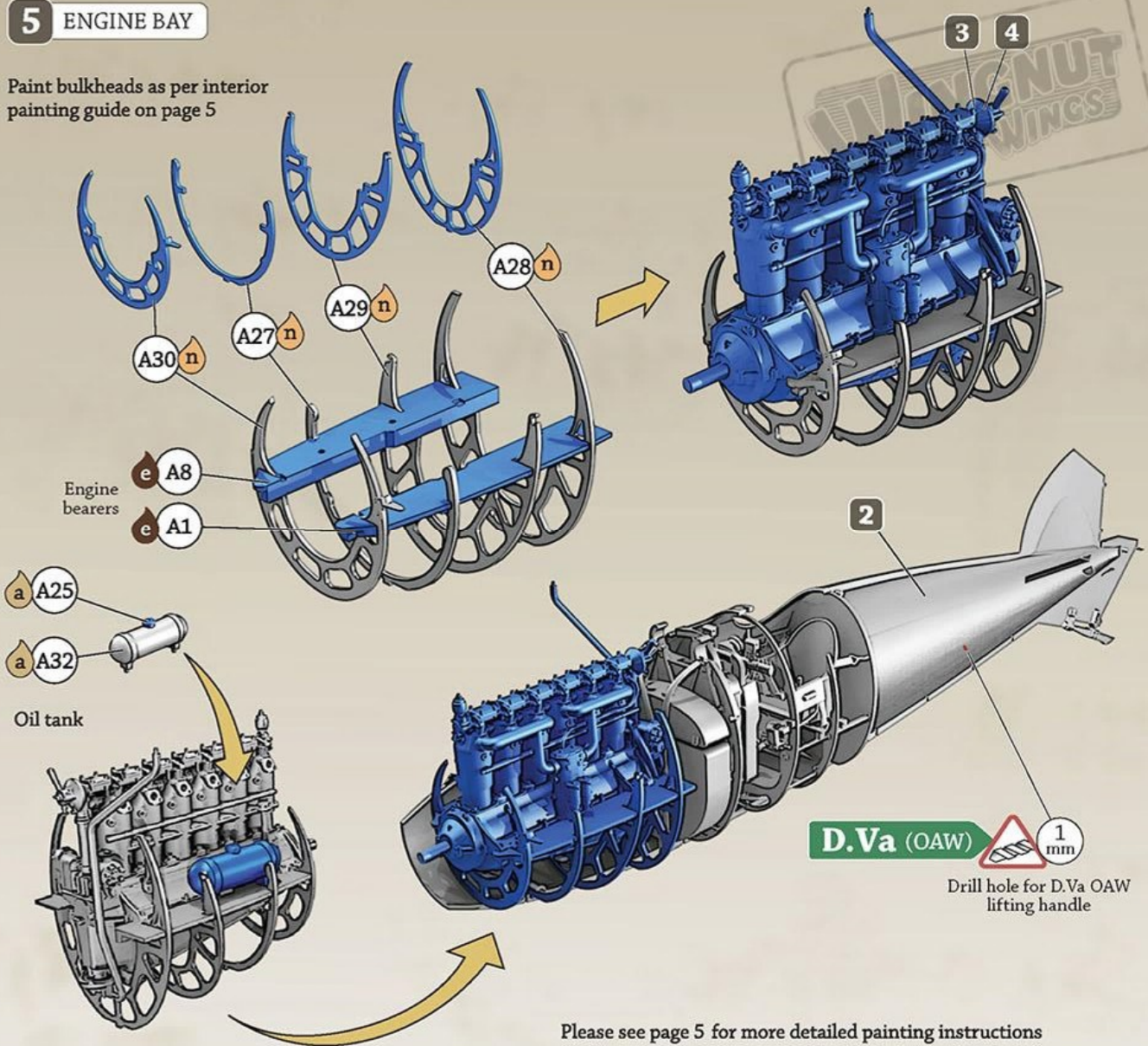

## 6 COCKPIT continued

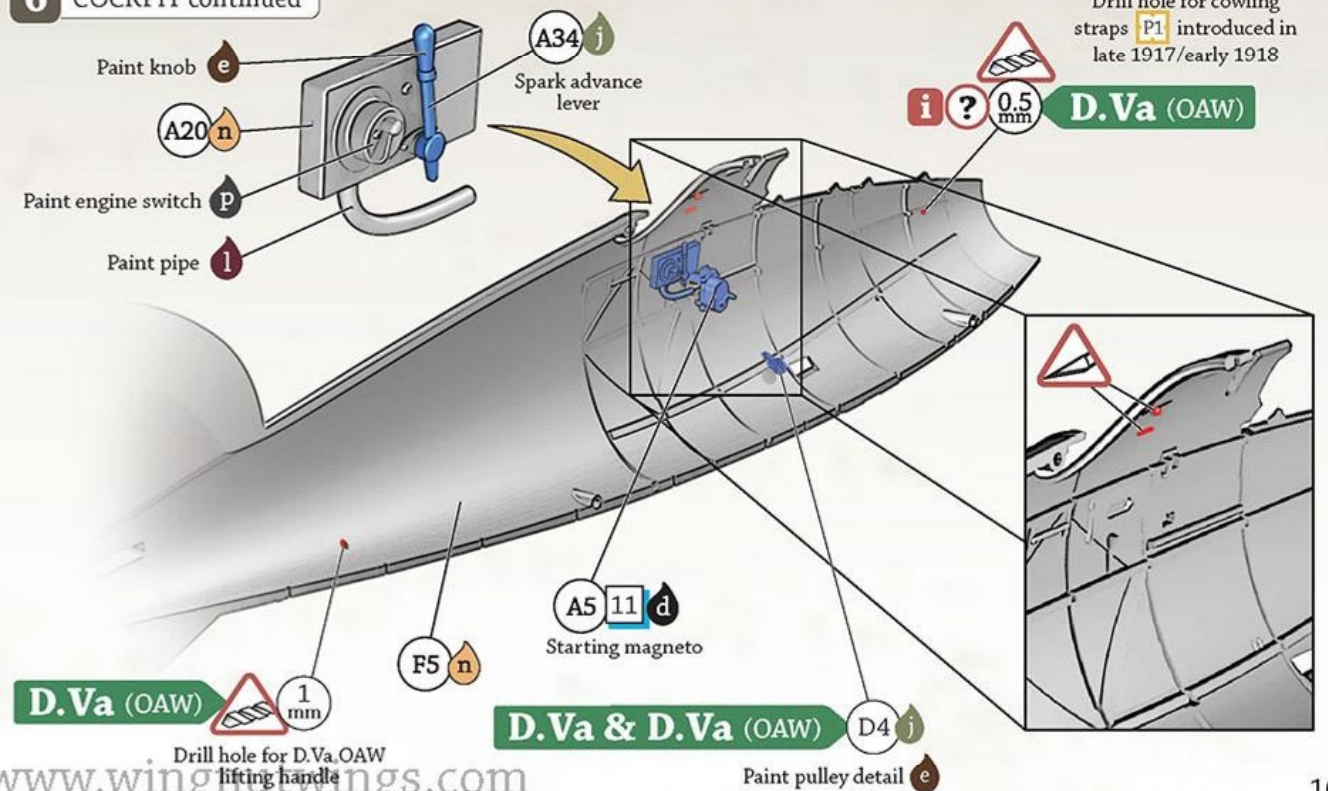



# 7 FUSELAGE ASSEMBLY AND TAILPLANE

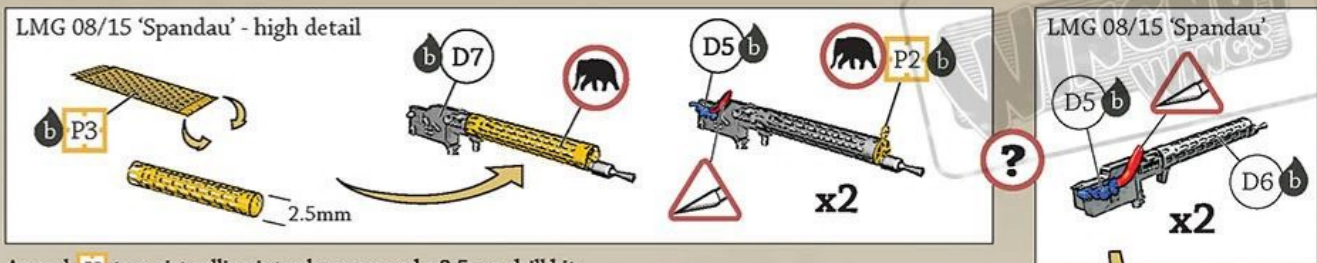

Anneal P3 to assist rolling into shape around a 2.5mm drill bit.

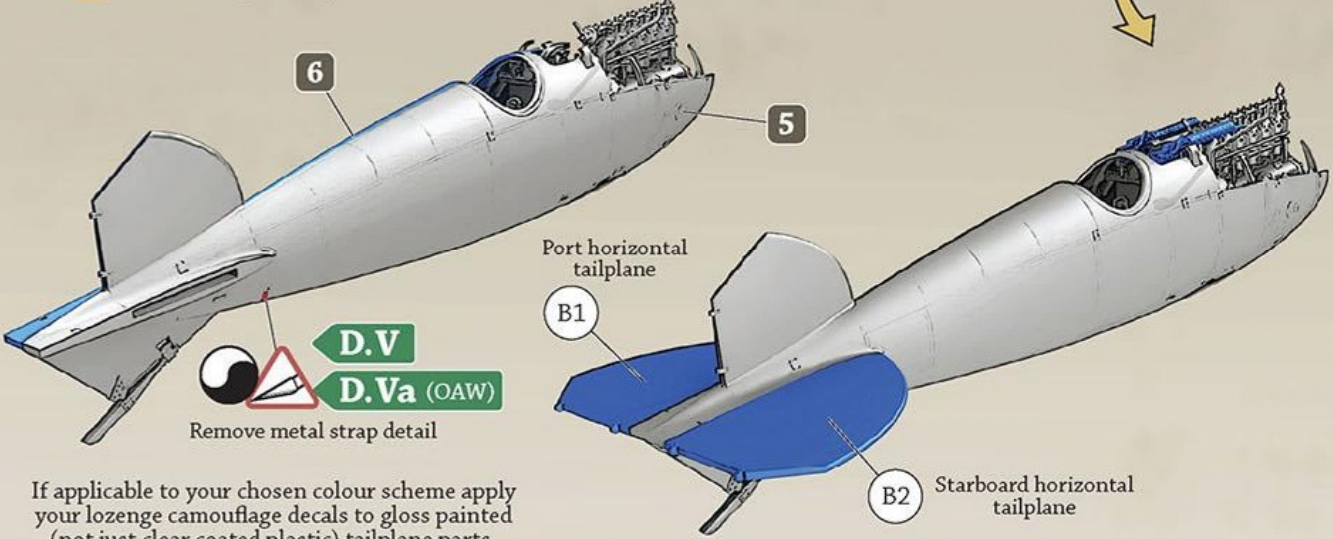

If applicable to your chosen colour scheme apply your lozenge camouflage decals to gloss painted (not just clear coated plastic) tailplane parts.

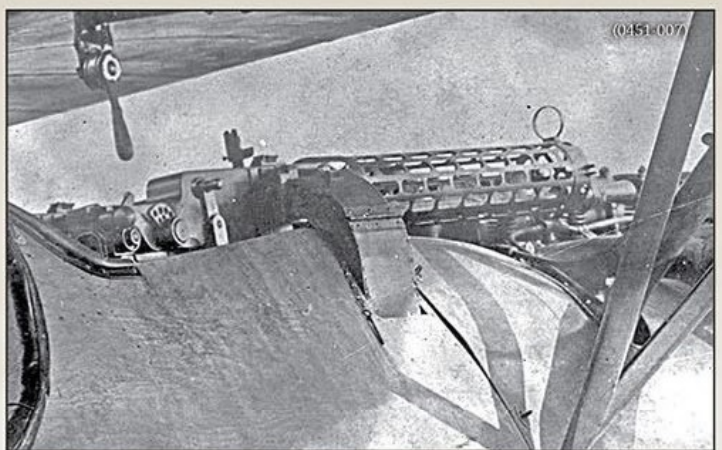
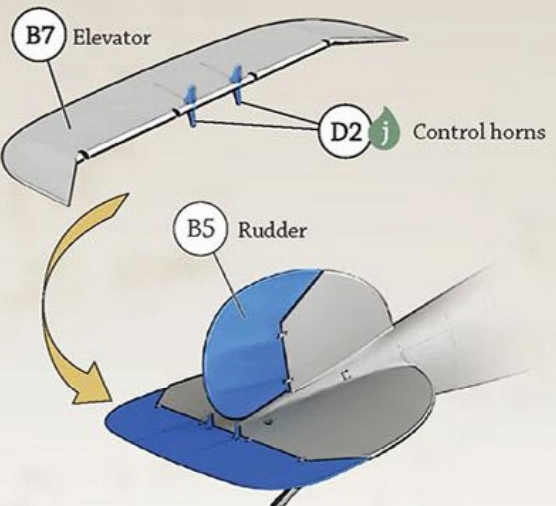

LMG 08/15 'Spandau' detail from an unidentified Johannisthal built Albatros D.Va. Note the lever attached to the top wing for adjusting the radiator shutters.



7 victory ace Helmut Dilthey's Royal Saxon Jasta 40 Albatros D.Va features reinforced 'V' strut wing brackets (D11), 5 colour lozenge fabric covering and modified 'post March 1918' balkenkreuz markings. Note the mirror (E39) attached to the top wing cut out.



## 8 FUSELAGE DETAILS

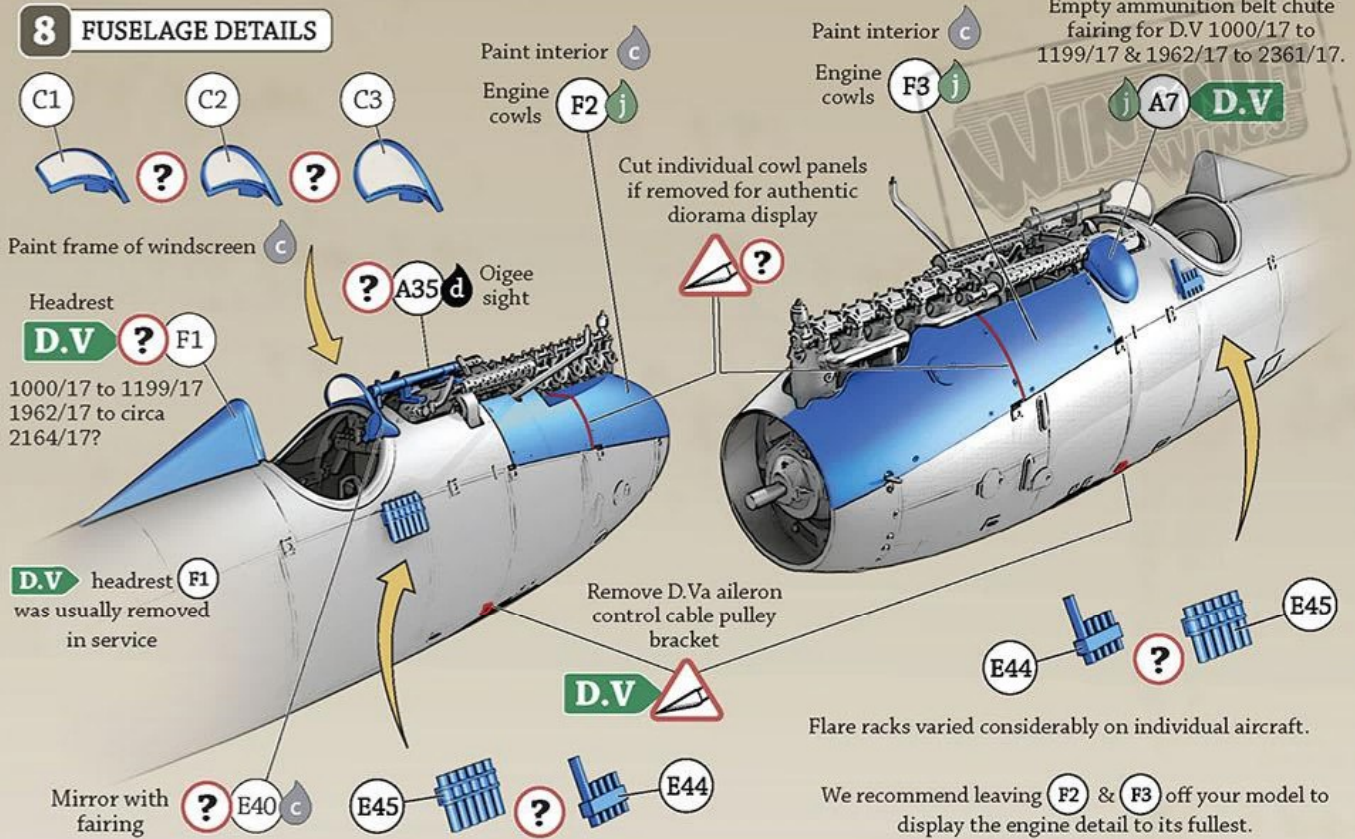

> 62 victory ace Ernst Udet sits in a relatively new unidentified early production Albatros D.V (not late production 4476/17) which conveniently shows the empty ammunition belt chute fairing **A7** which was found on D.V from the 1st production order placed in April 1917 (numbers 1000/17 to 1199/17) and 2nd production order placed in May 1917 (numbers 1962/17 to 2361/17). The headrest **F1** is only found on the D.V and were usually removed in service to allow more head movement for improved visibility and appear to have been deleted from production aircraft sometime after 2264/17. Note the unusual scoop at the rear of the radiator and 'colourful' safety harness straps.



Late production Albatros D.V 4640/17 'R' is from the 3rd and final production order for 300 D.V placed in July 1917 (numbers 4403/17 to 4702/17). The lack of the empty ammunition belt chute fairing **A7** is a feature of Albatros D.V from this production order and all D.Va and D.Va (OAW). Note the 180hp Daimler-Mercedes D.IIIa engine, lozenge fabric covering and unique position of the anemometer on the bottom wing. The aircraft in the background is a Gotha G.V to which Albatros D.V 4640/17 'R' served as escort.



## 9 BOTTOM WINGS

If applicable to your chosen colour scheme apply your lozenge camouflage decals to gloss painted (not just clear coated plastic) wing parts.

Starboard wing B4

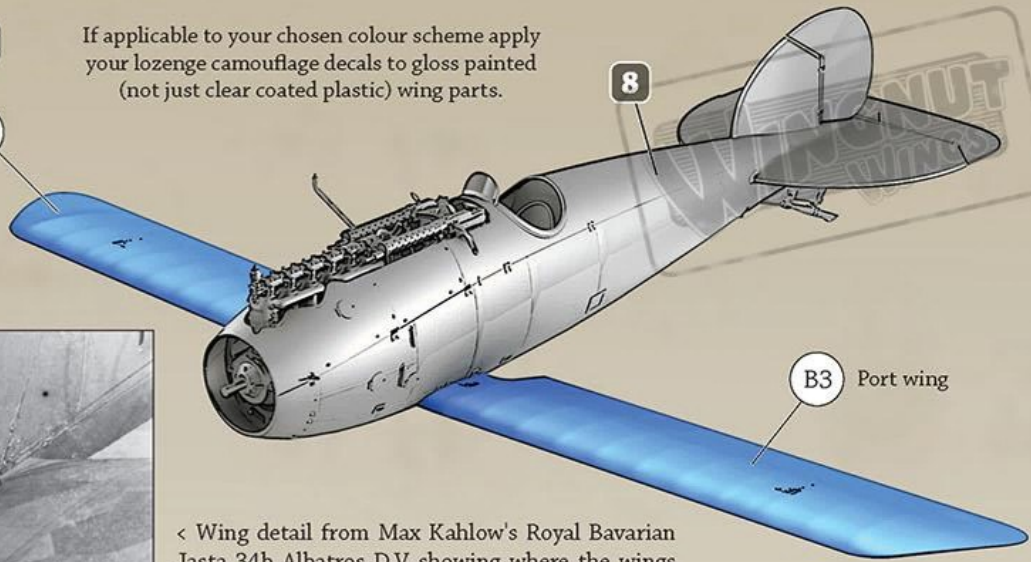

< Wing detail from Max Kahlow's Royal Bavarian Jasta 34b Albatros D.V showing where the wings attach to the wooden wing root fixed to the fuselage. Note the rigging attachment points and small size of the turnbuckles.

## 10 STRUTS

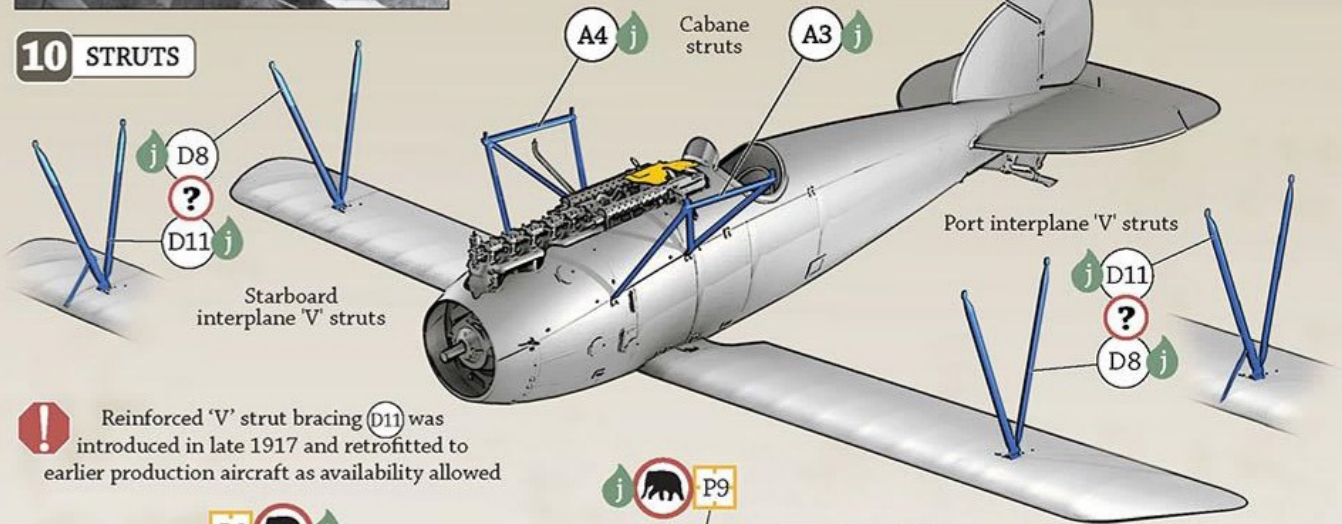

! Reinforced 'V' strut bracing (D11) was introduced in late 1917 and retrofitted to earlier production aircraft as availability allowed

D.V

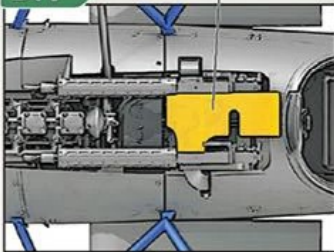

D.Va & D.Va (OAW)

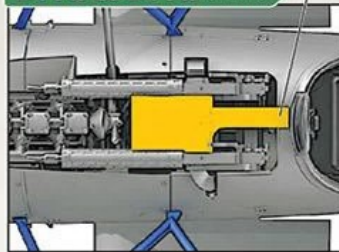

D.V D8

D.Va D8

5165/17 to 5426/17 & 5600/17 to 5849/17

D.Va D11

7000/17 to 7549/17

D.Va (OAW) D11

(Greg Van Wyngarden)



< Wing strut detail from Ernst Udet's Royal Prussian Jasta 37 late production Albatros D.V 4476/17 photographed in late 1917 showing the interplane 'V' struts fitted with additional wing bracing brackets (D11) which are more commonly associated with the D.Va. These brackets were introduced in late 1917 in an effort to prevent the bottom wing twisting on its single spar attachment and failing in flight and were retrofitted to earlier production aircraft as availability allowed.



γ Wing strut detail from Rudolf Clauß's Royal Prussian Jasta 29 early production Albatros D.Va 5390/17 photographed in December 1917 shows the original interplane 'V' struts (D8) (without additional wing bracing brackets).



# 11 TOP WING AND RADIATOR OPTIONS

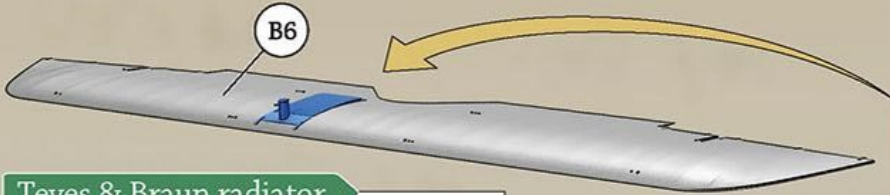

## Teves & Braun radiator



## Teves & Braun radiator



## Daimler-Mercedes radiator

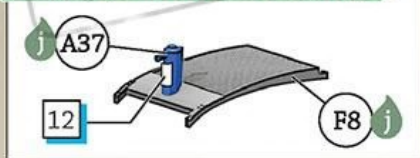

## Daimler-Mercedes radiator

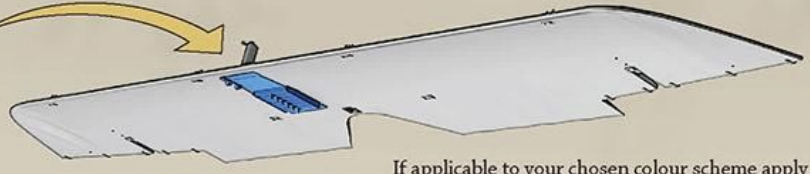
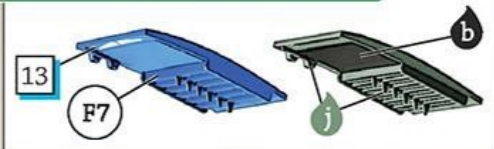

If applicable to your chosen colour scheme apply your lozenge camouflage decals to gloss painted (not just clear coated plastic) wing parts.



Unpainted aluminium Teves & Braun radiator detail from Manfred von Richthofen's Royal Prussian Jasta 11 Albatros D.V photographed on 6 July 1917.



Unpainted aluminium Teves & Braun radiator detail from Robert Ritter von Greim's Royal Bavarian Jasta 34b Albatros D.Va as seen on page 6.



Daimler-Mercedes radiator detail from Albert Tybelski's Royal Prussian Jasta 19 Albatros D.V 2104/17. Note the mirror (E39).



Daimler-Mercedes radiator detail from Rudolf Clauß's Royal Prussian Jasta 29 Albatros D.Va 5390/17 photographed in December 1917.

# 12 AILERONS

## D.V

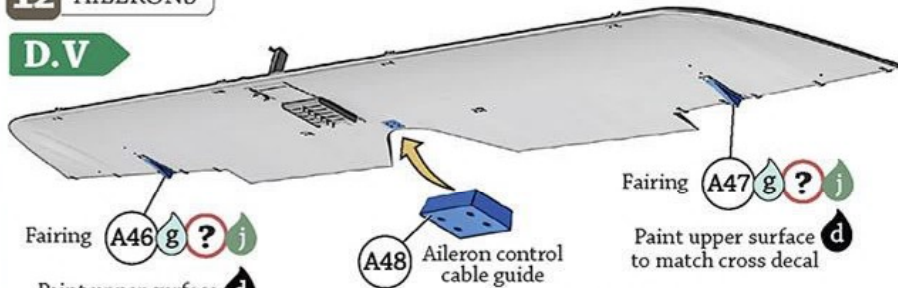

Fairing A46 g ? j  
Paint upper surface to match cross decal d

Fairing A47 g ? j  
Paint upper surface to match cross decal d

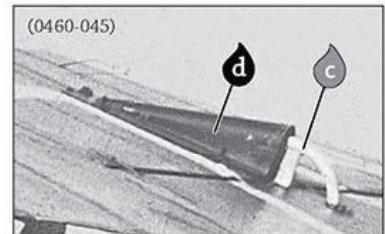

Detail shot of the D.V aileron control horn and cable fairing. The upper surface of this fairing has been painted black to match the cross, while the lower surface would be painted light blue to match the wing. On the lozenge covered wings the lower surface would be left in its grey-green primer j.

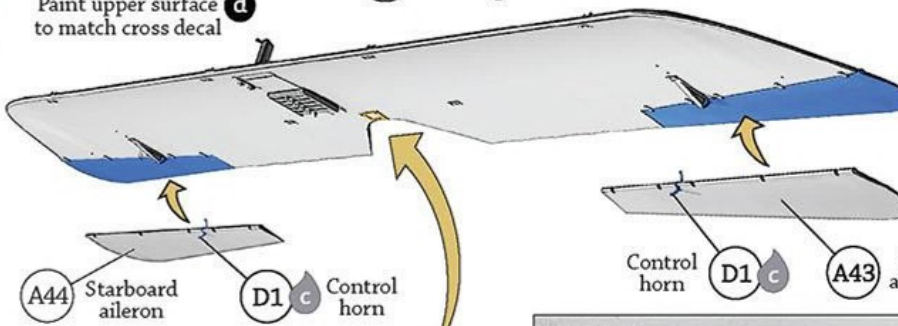

A44 Starboard aileron D1 Control horn

Control horn D1 c A43 Port aileron

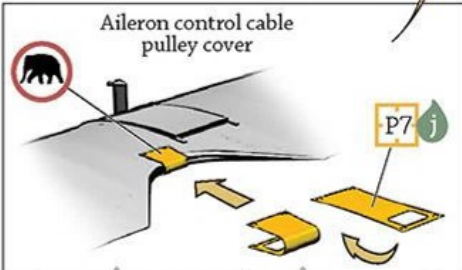

Aileron control cable pulley cover



Aileron control horn and cable fairing detail from Karl Schattauer's Royal Bavarian Jasta 16b Albatros D.V



**13** AILERONS continued

**D.Va & D.Va (OAW)**

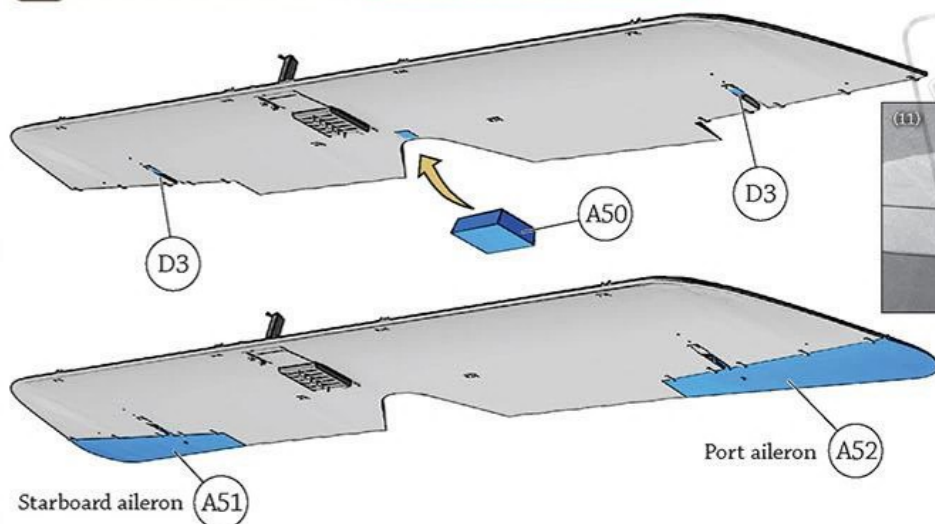

Aileron control horn detail from Robert Ritter von Greim's Royal Bavarian Jasta 34b Albatros D.Va as seen on page 6.

**14** ATTACH TOP WING & UNDERCARRIAGE

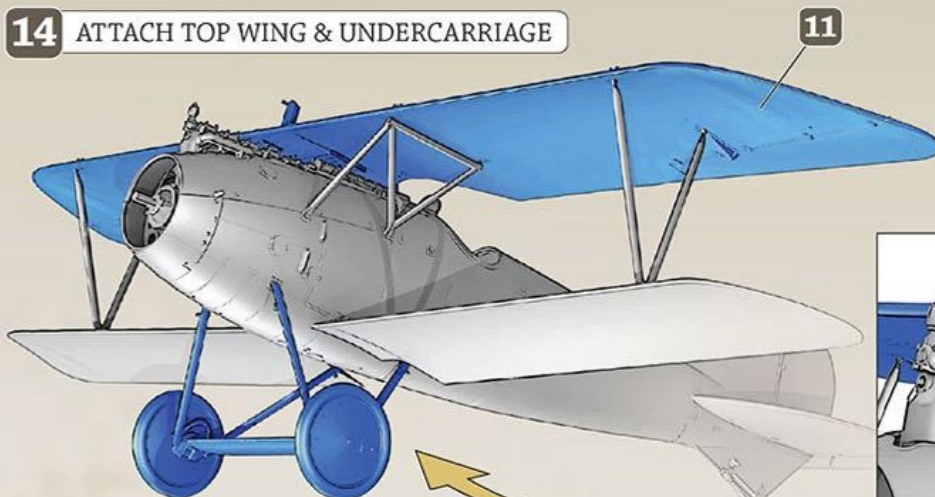

**!** Note position of radiator pipe

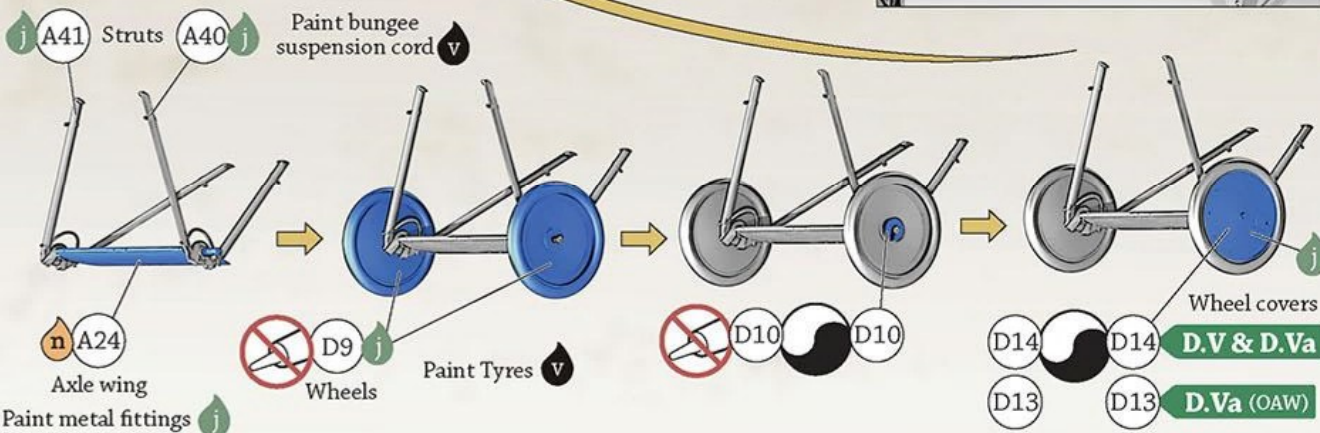
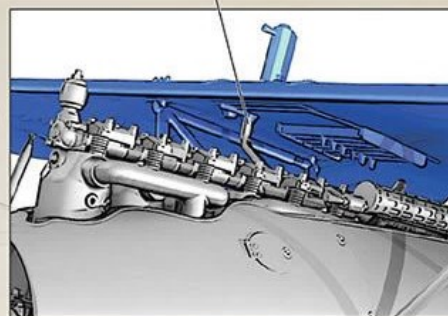

< Undercarriage detail from Albert Dietlin's Royal Prussian Jasta 41 late production Albatros D.V 4612/17 showing the common D.V & Johannisthal built D.Va style of tyre valve access & wheel cover (D14).

> Undercarriage detail from an unidentified OAW built Albatros D.Va showing the OAW style of tyre valve access & wheel cover (D13).





# 15 PROPELLER

Propellers were frequently damaged and replaced. While a photo may show a particular aircraft with a particular propeller it usually would not last very long and there is no guarantee that it would be replaced with another from the same manufacturer.

**Axial** E24 n & e

**Wolff** E23 n & e

**Niendorf** E46 n & e

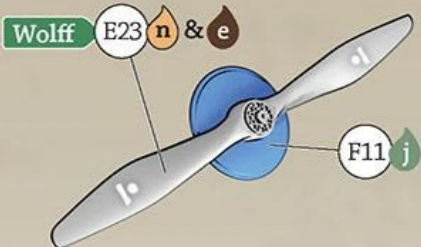
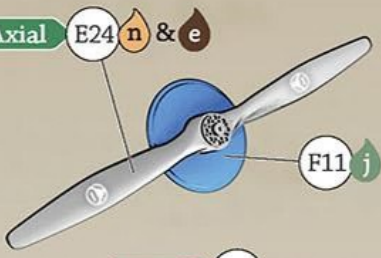

**Heine** E1 (not shown)

**i** Cowling straps introduced in late 1917/early 1918

**D.Va (OAW)**

Radiator pipe

F15 p

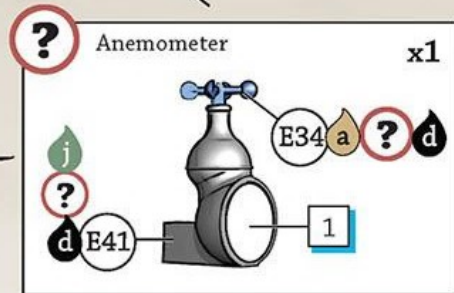
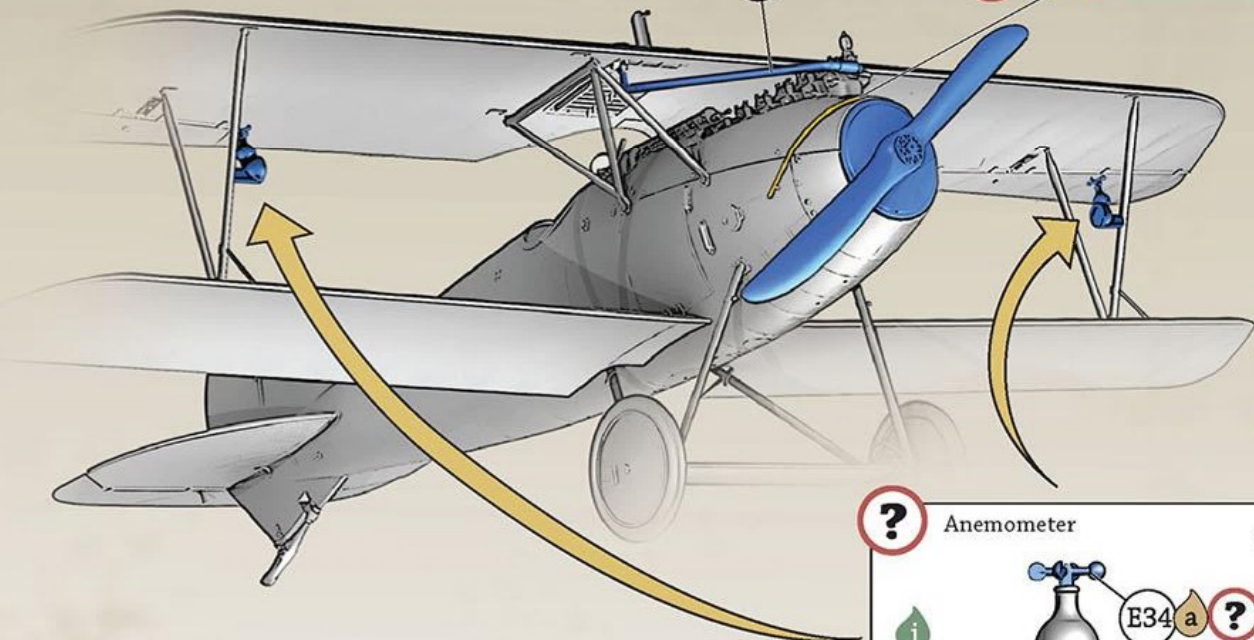

# 16 FINAL ASSEMBLY

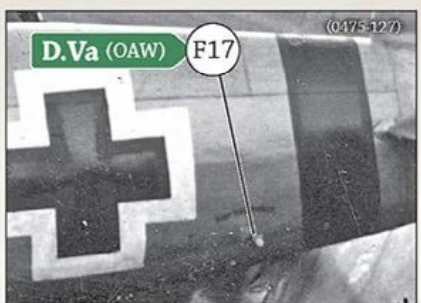

OAW style fuselage lifting handle (F17) from Albatros D.Va (OAW) 6753/17.

Exhaust  
p ? 1 A38

F4 j  
Spinner

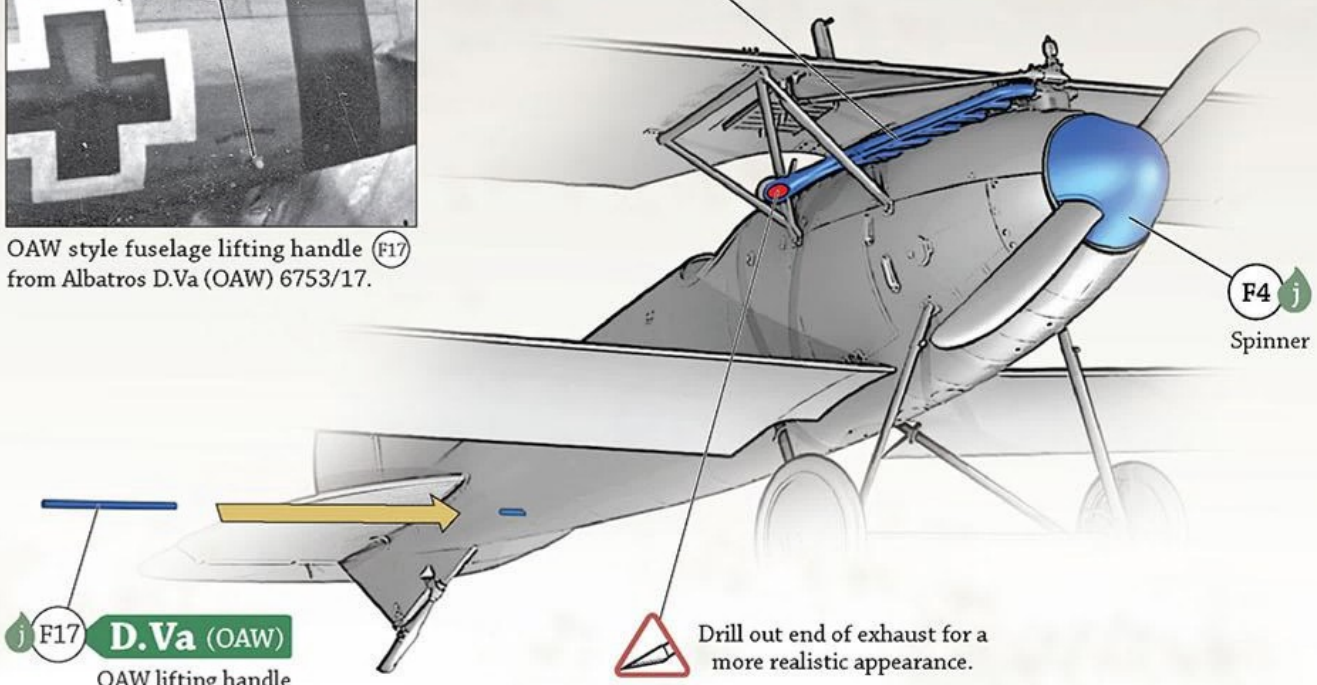

**F17 D.Va (OAW)**  
OAW lifting handle







Drill out end of exhaust for a more realistic appearance.

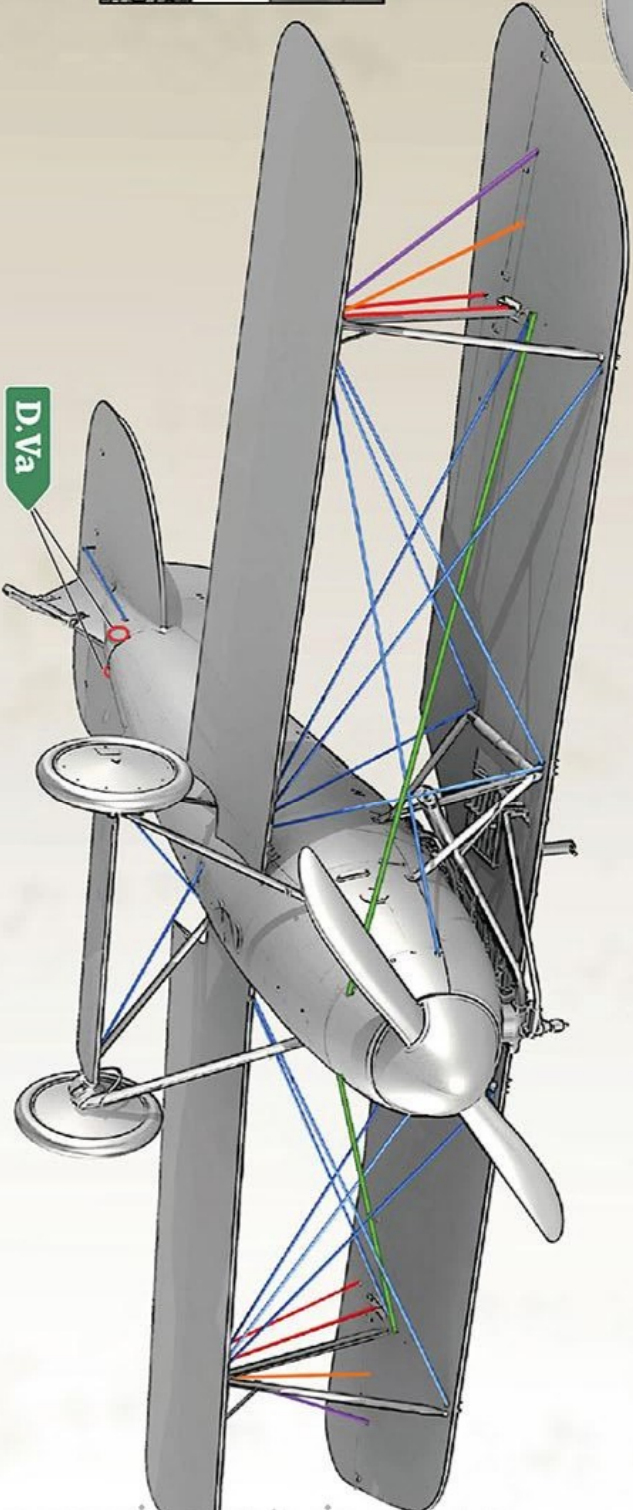
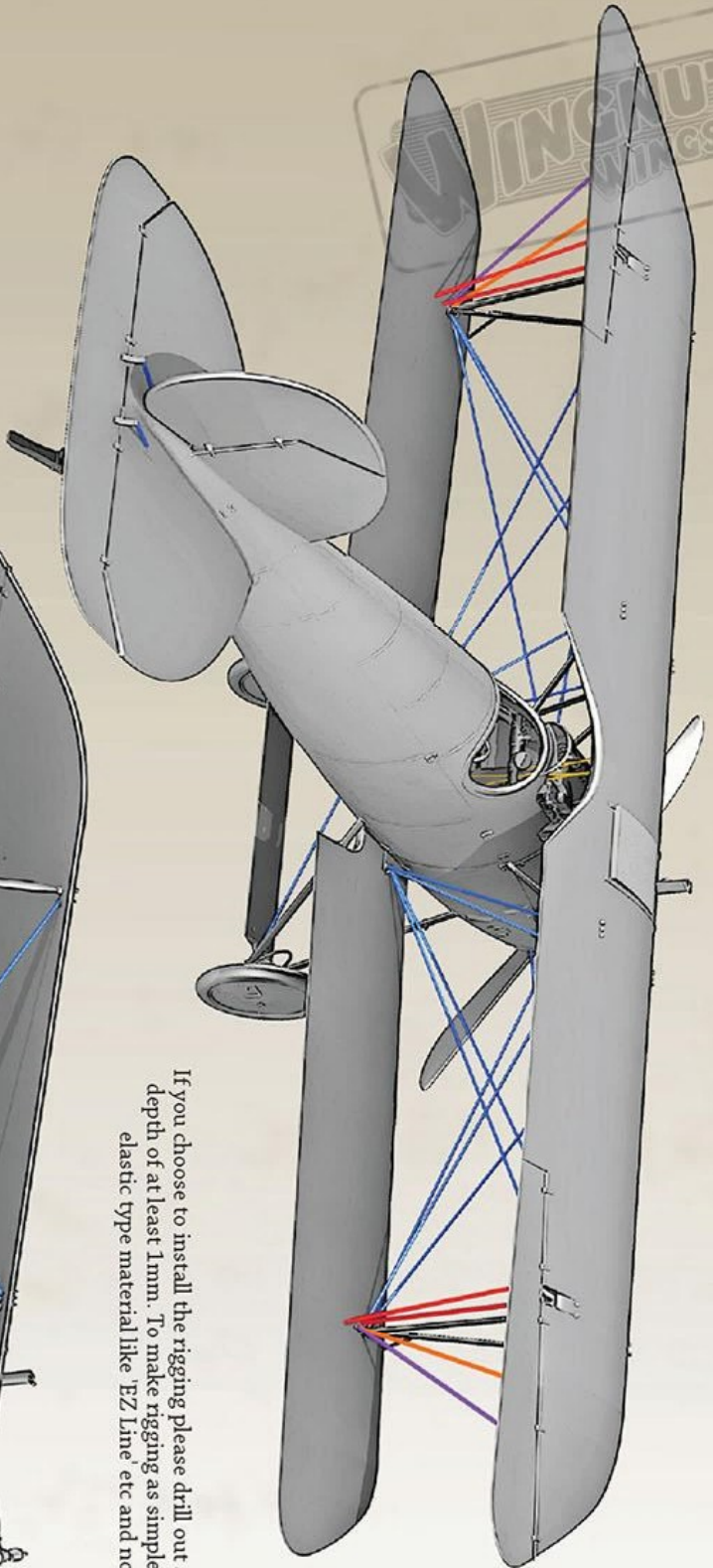

# RIGGING GUIDE

Rigging material not supplied



- 0.15mm  Common
- 0.15mm  D.V
- 0.15mm  D.Va & D.Va (AW)
- 0.15mm  ?
- 0.15mm  ?
- 0.15mm  ?

If you choose to install the rigging please drill out all location holes with a 0.5mm drill bit to a depth of at least 1mm. To make rigging as simple as possible we recommend using stretchy elastic type material like 'EZ Line' etc and not trying to replicate any turnbuckles.



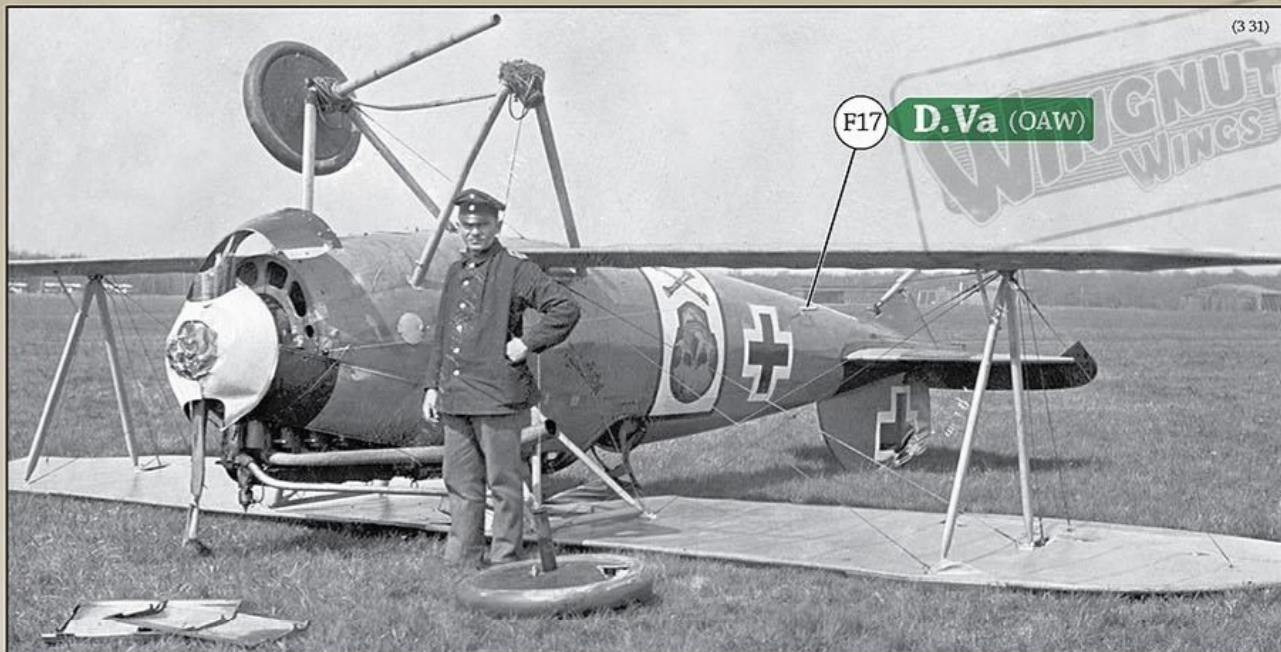

A mechanic poses in front of Hans von Goessel's crashed OAW built Albatros D.Va, the two undercarriage axle wing fairings at the bottom left of the photo possibly indicating the start of his salvage mission. Note the aileron control wires entering the upper wing, undercarriage bungee cords and OAW style lifting handle 'bar' protruding from the rear side of the fuselage. The name under the cockpit opening reads 'Margarethe'.



#### 3-D Modelling by Mark Miller

A background in technical illustration and long term passion for modelling and early aircraft has enabled Mark to produce some of the most stunning 3D renderings of aircraft anyone is likely to see. His artwork has appeared in numerous books and publications from Cross & Cockade, Over the Front, Schiffer and Windsock amongst others.

Mark worked for Wingnut Wings from 2007 to 2009.

To see some examples of Mark's work please visit <http://www.wwi-models.org/Images/Miller/render/index.html>

Additional 3D modelling by Bryan Wall.



#### Profile Art by Ronny Bar

Ronny Bar developed a keen interest in airplanes from an early age, living close at the El Palomar Air Force Base in Buenos Aires. He first flew in the back seat of a T-34 Mentor trainer at the age of ten, and was soon drawing airplanes and building models: Spitfires and Messerschmitt first... Camels and Fokkers later. He became a successful bass player with a career lasting over 35 years in several Rock bands, recording ten albums (one of them being a National hit selling more than 100,000 copies) and performing countless concerts, TV shows and tours all over Argentina.

Now retired from the R'n'R scene, his interest returned to his early passion: Aviation Artwork. Visiting the WW1 aircraft collection at Hendon focused his already growing interest for that historic period. His artwork is regularly appearing in journals and publications like Windsock Worldwide, Windsock Datafiles, Cross & Cockade and Over the Front.

Visit Ronny's Facebook page - [www.facebook.com/RONNY-BAR-Aircraft-Profiles-166538664131/](http://www.facebook.com/RONNY-BAR-Aircraft-Profiles-166538664131/)



#### Product Manager, Richard Alexander

A native of Wellington New Zealand, Richard Alexander has a long term interest in military history, race cars & local drivers from motor sports golden era of the '60's. An accomplished modeller Richard's models have twice been awarded Best Overall in Show at IPMS(NZ) National Conventions and earned him the inaugural TamiyaCon(NZ) Master Modeller award (along with the associated trip to Japan) in 2001. Many of his works are in private collections around the world, though he no longer accepts commissions.

Richard has been in the model and hobby industry since 1991 and brings with him a keen eye for detail and a passion for ensuring our models are enjoyable to build. So if there is anything you don't like about this model, you can blame him.

If you do have comments, requests or suggestions, Richard is contactable at [richard@wingnutwings.com](mailto:richard@wingnutwings.com)



#### Decal Art by Malcolm Laird

Malcolm has been in the scale model industry since 1981 and now produces his line of Ventura decals and a range of soft cover aviation books mainly with a Kiwi flavour. Outside work he suffers the dual afflictions of restoring old Kawasaki motorcycles and trying to paint impressionist landscapes, with 'mixed' results so far.

Visit Malcolm's web site at [www.venturapublications.com](http://www.venturapublications.com).

**Errata** - Please check our website in case there are any corrections and updated information regarding this model.

- 30011 **C** Walter Kleffel, Jasta 18, January 1918 (1 victory). Updated painting and decal illustrations on our website.
- 30013 **E** Elevator is probably black **d** and not white as illustrated.
- 30014 **C** D.III engine.
- 30015 **A** Max Müller was reportedly shot down in Albatros D.Va 5405/17.
- 30016 **A** Not 5787/17. (serial number is still unconfirmed as at December 2018).
- 30017 **D** Updated colour scheme illustration on our website.



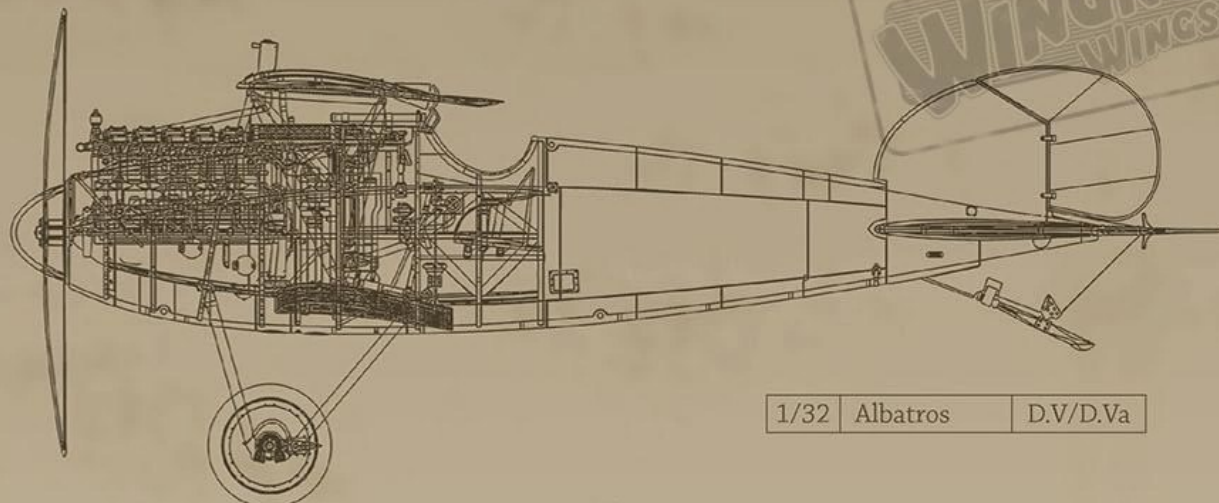

1/32 Albatros D.V/D.Va

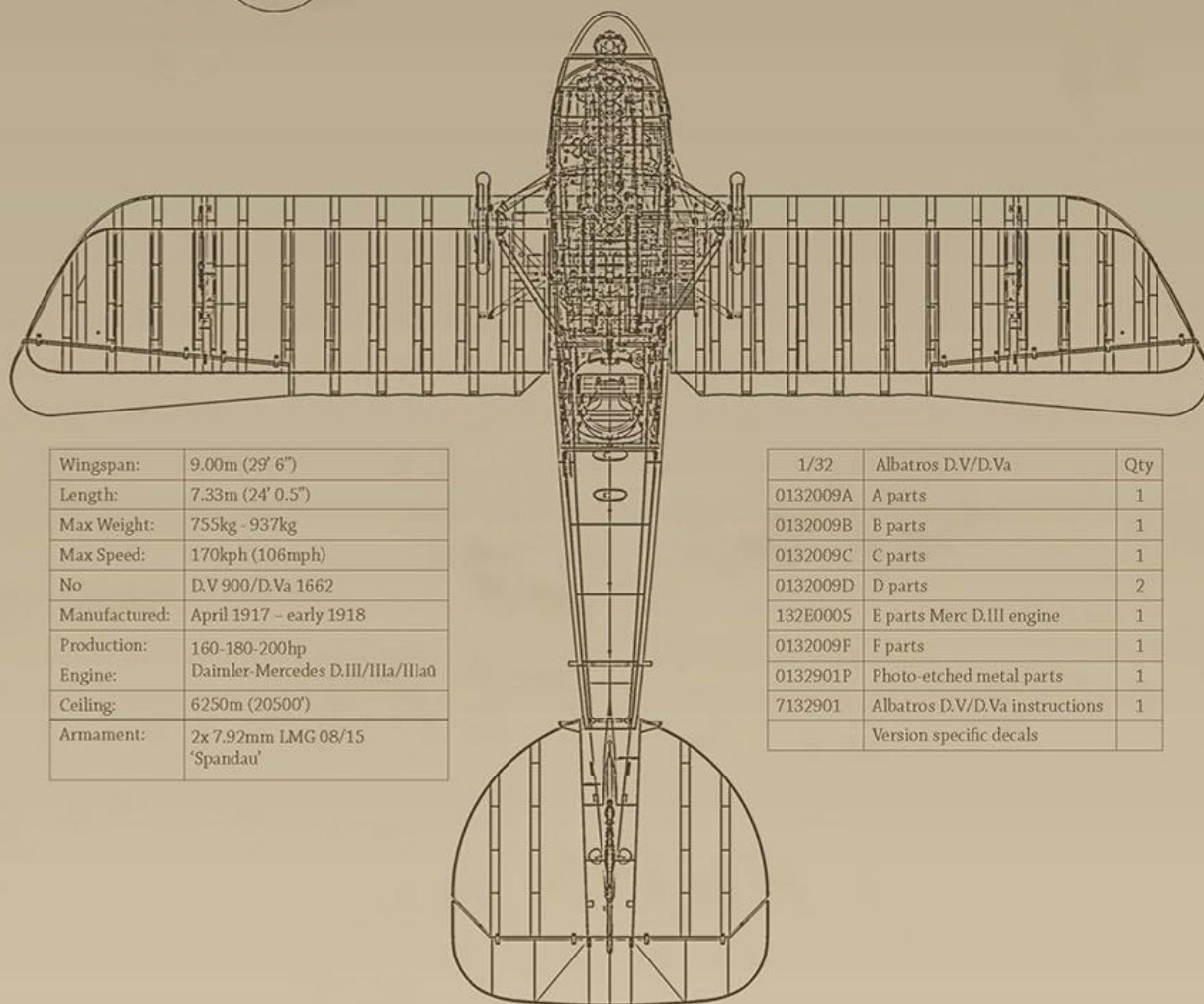

Wingspan:	9.00m (29' 6")
Length:	7.33m (24' 0.5")
Max Weight:	755kg - 937kg
Max Speed:	170kph (106mph)
No	D.V 900/D.Va 1662
Manufactured:	April 1917 - early 1918
Production:	160-180-200hp
Engine:	Daimler-Mercedes D.III/IIIa/IIIa0
Ceiling:	6250m (20500')
Armament:	2x 7.92mm LMG 08/15 'Spandau'

1/32	Albatros D.V/D.Va	Qty
0132009A	A parts	1
0132009B	B parts	1
0132009C	C parts	1
0132009D	D parts	2
132E0005	E parts Merc D.III engine	1
0132009F	F parts	1
0132901P	Photo-etched metal parts	1
7132901	Albatros D.V/D.Va instructions	1
	Version specific decals	

If you have any damaged or missing parts please contact [help@wingnutwings.com](mailto:help@wingnutwings.com) for assistance.

[www.wingnutwings.com](http://www.wingnutwings.com)

©2019 Wingnut Wings Ltd. PO Box 15-319 Miramar, Wellington 6022 New Zealand.

All rights reserved. Designed in New Zealand - Manufactured in China.

[www.wingnutwings.com](http://www.wingnutwings.com)







**A** Albatros D.Va 5787/17 "stripes", Jasta 76b, Late 1917 to early 1918

Use optional parts C3 D11 E1 F7 F8 and Daimler Mercedes D.IIIa 180hp engine.

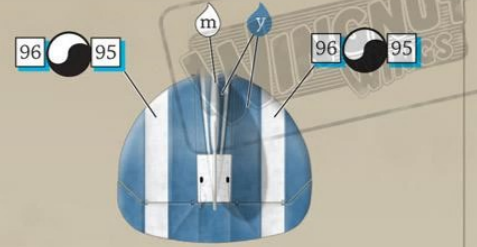
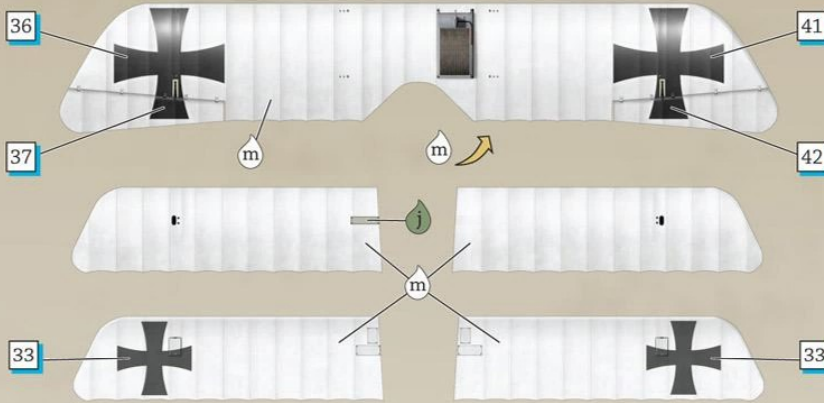

This Albatros D.Va had previously been identified as one of two D.Va believed to have been flown by Walter Böhning while commanding Jasta 76b from October 1917 to May 1918 but this is now known to be incorrect and the identity of the pilot is unconfirmed at this time. This Royal Bavarian Jasta 76b Albatros D.Va is seen here after being disassembled for transportation by railway carriage. The fuselage has been painted in dark and light stripes which appear to be Bavarian blue and white. The tailplane visible in the foreground exhibits Jasta 76b markings of blue with 2 white stripes. The wings on the left of the photo are almost certainly from this aircraft and could be all over white as we have illustrated. Note the Albatros company decal on the rudder, proportions of the fuselage stripes and white propeller spinner in the foreground. One of the mechanics is using the flare pistol mounting tube below the cockpit opening as a convenient lifting handle.



**B** Albatros D.Va, Lt. Diem, Jasta 76b, February-March 1917 (1 victory)

Use optional parts C2 E24 D11 E39 F6 F9 and Daimler Mercedes D.IIIa 180hp engine.

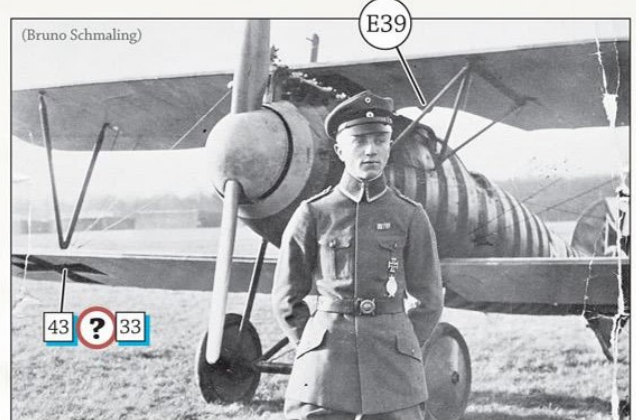
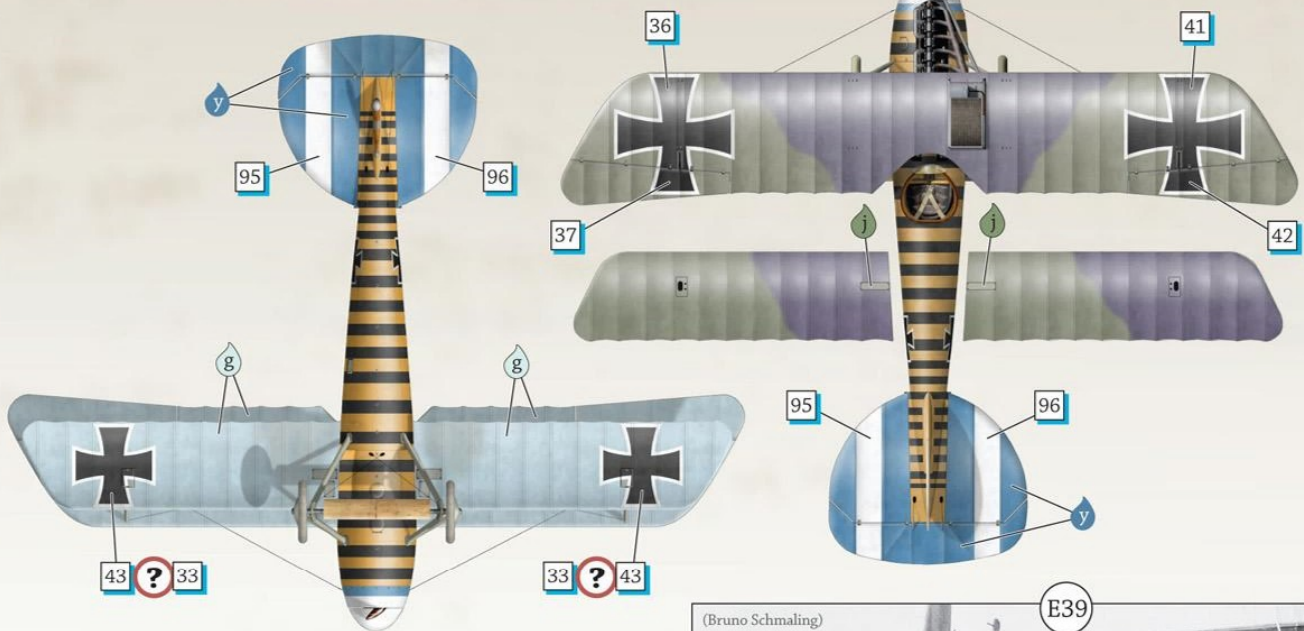

Hans Böhning strikes a pose in front of what almost everyone thought was his Jasta 76b Albatros D.Va which, thanks to information provided by German historian Bruno Schmalig, has now been more accurately identified as Lt Diem's yellow & black banded aircraft. Lt. Diem served with Jasta 76b from mid February until the armistice and was credited with 1 victory on 31 May 1918.



### C Albatros D.Va, Hans Böhning, Jasta 76b, (17 victories) & Karl Hopf, 1918

Use optional parts (A35) (C2) (D8) (E46) (F7) (F8) and Daimler Mercedes D.IIIa 180hp engine.

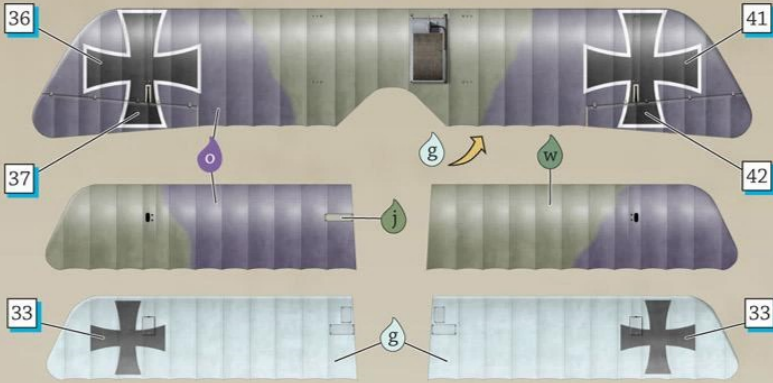

This attractively decorated D.Va was flown by Hans Böhning, despite previously being incorrectly attributed to Walter Böning, and is shown here as it looked after it was taken over by Karl Hopf, who can be seen sitting on the edge of the cockpit. It was Hopf who has added the Wappen (heraldic shield) of his native Würzburg [75]. Hans Böhning was born in Bavaria on 6 July 1893 and served in the artillery before transferring to the air service in early 1917. He served with FA(A) 290, Jastas 36, 76b, 79b and 32b which he commanded for the last 11 days of the war. Hans survived the Great War with a total of 17 victories to his credit but died in a sailplane accident in 1934. He was 41. No details of Karl Hopf's service are known to us. Note how the off-white of the Bavarian diamond scheme is darker than the white of the fuselage cross. The rear view photo shows the Daimler-Mercedes radiator, green and mauve camouflage pattern and D.V style 'V' struts (D8).

### D Albatros D.Va OAW 6633/17, Michael Sigmann, Jasta 78b, April-August 1918

Use optional parts (C2) (D11) (D13) (E23) (E44) (F7) (F8) (F17) and Daimler Mercedes D.IIIa 180hp engine.

Note the position and orientation of the lozenge and rib tape decals.

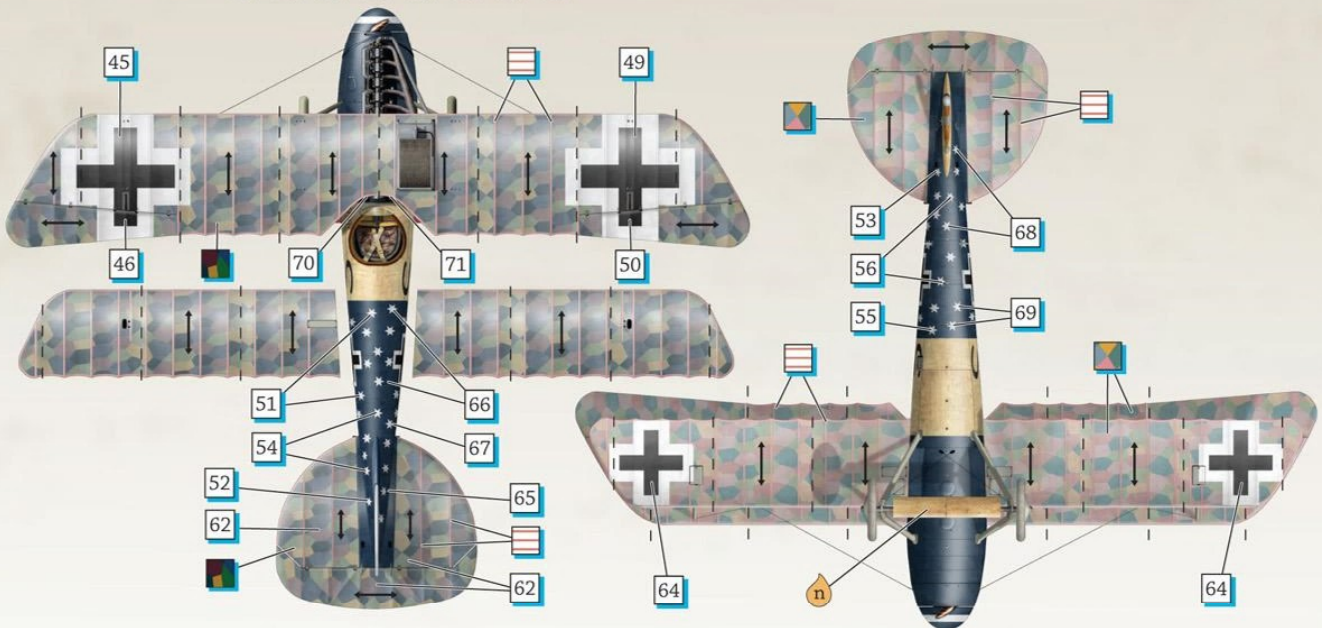

These photographs are both believed to show Michael Sigmann's attractively painted midnight blue (not black as previously thought) OAW built Jasta 78b Albatros D.Va 6633/17. With eisernkruz and a white ring around the spinner sometime before his personal 'S' marking was applied and later with modified April 1918 style balkenkruz. At some time during Michael's service with Jasta 78b from February 1918 until he was wounded in August 1918, his large black 'S' was scraped off the fuselage side. Interesting details to note include the left outer wheel cover from an OAW built Albatros D.III, believed to have been 5115/17 and flare rack under the cockpit.

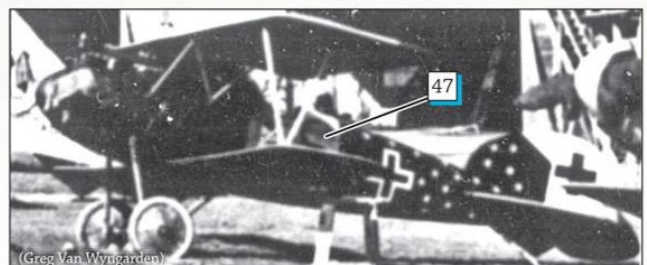
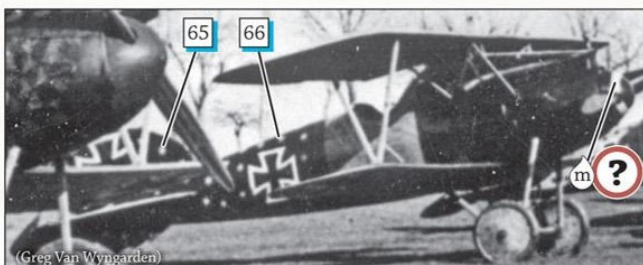



**E Albatros D.Va, Eduard Ritter von Schleich, JG8b, March 1918 (35 Victories)**

Use optional parts (C2) (D11) (A35) (E40) (E46) (F6) (F9) and Daimler Mercedes D.IIIa 180hp engine.

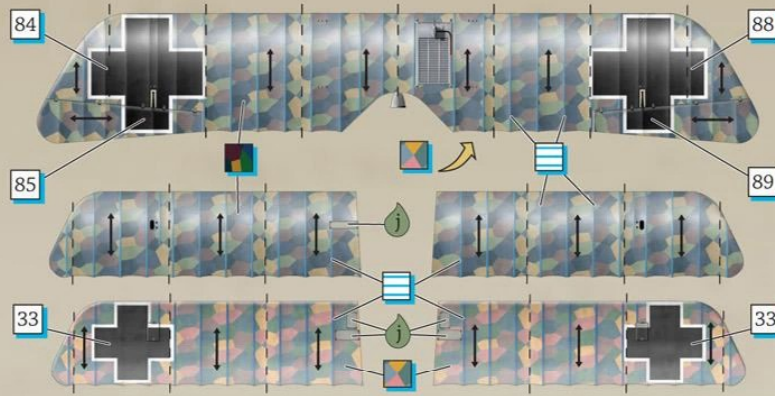

The 'Black Knight' Eduard Ritter von Schleich strikes a famous pose beside his black Albatros D.Va, previously flown by Otto Kissenberth. Schleich joined the 11th Bavarian Infantry Regiment in 1908 and was severely wounded in August 1914. After recovering he transferred to aviation and gained his Bavarian Pilot's badge in September 1915. Eduard served in, and commanded, various units before being made commander of Bavarian Jagdgruppe 8 in March 1918. He survived the First World War with 35 victories and the Pour Le Merite 'Blue Max' to his name, flew against the communists in 1919 and joined Lufthansa in 1920. In 1933 he joined the Luftwaffe and commanded various units before becoming General de Flieger in occupied Norway. He died on the 15th of November 1947 in a British POW camp aged 59. Note the small scope protruding through a hole cut in the windshield and the rear view mirror (E40) on the upper wing. A flare rack is fixed to the right side of the fuselage (not visible here). Otto Kissenberth's Edelweiss fuselage marking is faintly visible beneath a worn coat of black paint.

	All Colours	Tamiya	Humbrol	Misterkit
d	Black - semi gloss	X18	85	
e	Dark Wood - gloss	XF68	98	
f	Leather - semi gloss	XF52	62	
g	Light Blue - gloss	XF10(x10) + XF18(x1)	34(x10) + 96(x1)	25550
h	Chrome Yellow - semi gloss	XF3(x10) + X6(x1)	24	33637
i	Light Grey - matt	XF19	64	36463
j	Interior Grey Green - matt	XF76	90	24424
m	White - semi gloss	XF2	34	
n	Light Wood - gloss	XF59	93	
o	Mauve - gloss	X16(x2) + XF52(x1)	68(x5) + 29(x1)	-
p	Steel	XF56	27003	
v	Rubber - matt	XF69	66	
w	Medium Grey Green - gloss	XF71	78	34227
x	Midnight Blue - semi gloss	XF17	-	15045
y	Bavarian Blue - semi gloss	X4(x1) + XF2(x3)	25 (x1) + 22(x3)	-
z	Off White - semi gloss	X2(x2) + XF55(x1)	22(x2) + 28(x1)	-
	 Decal 30001 5 Colour Upper Lozenge – available separately			
	 Decal 30002 5 Colour Lower Lozenge – available separately			
	 Decal 30005 German Rib Tapes for Lozenge – available separately			



If you require assistance please contact - [help@wingnutwings.com](mailto:help@wingnutwings.com)

[www.wingnutwings.com](http://www.wingnutwings.com)

©2016 Wingnut Wings Ltd. PO Box 15-319 Miramar, Wellington 6022 New Zealand.

All rights reserved. Designed in New Zealand.

7230016

[www.wingnutwings.com](http://www.wingnutwings.com)