

Albatros D.V/D.Va

1/32 Scale

Johannisthal based Albatros Flugzeugwerke GmbH were responsible for some of the most graceful and effective fighters of the Great War. Their twin gun, semi-monocoque plywood fuselage Albatros D.1, powered by a 160hp Daimler Mercedes D.III engine, arrived at the front in September 1916 and achieved instant air superiority over its main opposition of Nieuport 11 and DH.2 fighters. Followed immediately by the slightly improved D.II and in December 1916 by the much improved D.III, with its V strutted sesquiplane wing greatly influenced by the successful Nieuport fighters. The D.III was more maneuverable than the D.II and its single spar lower half wing afforded greater visibility for the pilot but was also the cause of numerous, frequently fatal, structural failures. Despite much effort this problem was never fully resolved. Nevertheless the D.III remained in production well into late 1917.

Even as the excellent D.III went into production plans were underway for its successor, the Albatros D.V. Retaining the wings of the D.III but with aileron controls routed through the upper wing and with a redesigned fuselage completely oval in section, the D.V was arguably the best looking of all Albatros designs. Unfortunately the D.V inherited the lower wing structural failure problem of the D.III and turned out to not be any real improvement over it performance wise either. Despite this, the Albatros D.V and the D.Va (with aileron controls cables reverted to D.III configuration), were manufactured in greater numbers than any previous German fighter of the war (only surpassed later by the Fokker D.VII, of which Albatros manufactured the great majority).

The Albatros D.V weighed 620kg empty when production commenced in April 1917 but, following strengthening, the empty weight had increased to 680kg before production of the D.Va started in August 1917. While Johannisthal built D.Va remained 680kg throughout production, those ordered from Ostdeutsche Albatros Werke (OAW) in September-October 1917 weighed in at 717kg empty, almost 100kg heavier than the initial D.V. When the Albatros D.V started appearing at the front in May 1917 it was effectively outclassed by the improved SE.5a, Sopwith Camel and SPAD fighters being fielded by the allies at the time. Even after the introduction of the superb Fokker D.VII the Albatros D.V and D.Va could still be found equipping front line Jastas, although most had been relegated to training or home defense duties by the time of the Armistice. Note that these instructions illustrate parts to build Johannisthal built Albatros D.V & D.Va and Ostdeutsche Albatros Werke (OAW) built D.Va. Please make sure you take note of the different parts required for your chosen decal scheme. Any history of this important aircraft here is of necessity very brief, therefore we encourage you to seek out any, or all, of the reference books mentioned below for a more thorough understanding.

WW1 colour schemes are contentious at the best of times and we have done our best to provide what we consider to be accurate painting information for this model. The colourful unit and personal markings applied to the various German fighters of the Great War have attracted more than their fair share of debate over the years and, while we have been as meticulous as we could be, I'm sure some will not find our choices to their liking. Albatros D.V/D.Va fuselages were usually clear varnished resulting in a yellowish plywood colour. The fabric covered wings and tailplane were finished in either of 2 ways, painted (with medium grey green & mauve or dark grey green & lilac on top with light blue below) or covered in pre-printed lozenge camouflage fabric, some of which was almost certainly overpainted with a transparent (brown?) glaze to tone down the vibrant colours. Metal fittings were painted in pale grey-green, as was much of the engine bay. Exterior metal panels and fittings were usually painted in this same pale grey-green colour although some late production D.Va were finished in a darker grey-green colour. There was considerable freedom for German units to apply their own colour schemes to their aircraft with some using drab camouflage paints, usually applied with a 'loofah' type sponge, while others preferred highly visible colours to aid identification at a distance. Additionally individual pilot's markings were also applied in a fashion dictated by the unit commander.

Richard Alexander 2019

Wingspan:	Length:	Max Weight:	Max Speed:
9.00m (29' 6")	7.33m (24' 0.5")	755kg - 937kg	170kph (106mph)
No. Manufactured:	Production:	Armament:	
D.V 900/D.Va 1662	April 1917 - early 1918	2x 7.92mm LMG 08/15 'Spandau'	
Ceiling:	Engine:		
6250m (20500')	160-180-200hp Daimler-Mercedes D.III/IIIa/IIIaü		

References:

Windsock Datafile 3 Albatros D.V, Ray Rimell, 1987 - Albatros Fighters Windsock Datafile Special, Ray Rimell, 1991
 Squadron Signal Albatros Fighters in Action, John F Connors, 1981 - Australian War Memorial Museum, Canberra, Australia
 The Vintage Aviator LTD. - 1914-18 Aviation Heritage Trust - Private Collections

Albatros D.V/D.Va

1/32 Scale

- Warning:** Choking hazard. Keep small parts and plastic bags away from children. Use glue and paint in a well ventilated area. Always wear protective eyewear when cutting and a protective mask when painting, gluing and sanding. Do not breathe dust from polyurethane resin parts (if included). Beware of sharp edges on metal parts.
- Assembly:** **Read all the instructions carefully before starting assembly.** Use glue intended for plastic models. Assemble metal and resin parts (if included) using Cyanoacrylate (CA) or epoxy glue. Before assembly select a marking option and note optional parts required in instructions.
- Rigging:** If installing rigging please drill out all location holes with a 0.5mm drill bit to a depth of at least 1mm. To make rigging as simple as possible we recommend using stretchy elastic type material like 'EZ Line' etc and not trying to replicate any turnbuckles.
- Painting:** Only use paints **designed and suitable** for plastic model kitsets.
- Decals:** Cut out each decal as required. Soak in warm water for 15 seconds. Slide off backing paper onto **gloss painted surface of model (not just clear coated plastic)**. For large decals it is helpful to apply a drop of water to the area they are being applied to. This will make it easier to maneuver them into the correct position.

Hints & Tips: Please visit our website for additional photos, hints and tips to assist you in getting the best result from your Wingnut Wings model.

1 Construction Step	Choose	Attention	Remove
A1 Part Number	Do Not Cement	Option	Drill
5 Decal	Cement For Metal	Other Side	Paint Colour
P1 Photo Etch Part			

All colours		Humbrol	Federal Standard
a	Brass	X31	54
b	Gun Metal	X10	27004
c	Aluminium	XF16	27001
d	Black - semi gloss	X18	85
e	Dark Wood* - gloss	XF68	98
f	Leather - semi gloss	XF52	62
g	Light Blue - gloss	XF2(x10) + XF18(x1)	130(x10) + 96(x1)
h	Chrome Yellow - semi gloss	XF3(x10) + X6(x1)	24
i	Light Grey - matt	XF19	64
j	Interior Grey Green	XF76	240
k	Red - semi gloss	X7	19
l	Rust - matt	XF9	113
m	White - semi gloss	XF2	130
n	Light Wood* - gloss	XF59	93
o	Mauve - semi gloss	X16(x2) + XF52(x1)	68(x5) + 29(x1)
p	Steel	XF56	27003
q	Clear Doped Linen - semi gloss	XF55	148
r	Camouflage Green - matt	XF65	116
s	Copper	XF6	12
t	Green - gloss	X28	208
u	Silver	XF16(x2) + XF19(x1)	11(x1) + 34(x1)
v	Rubber - matt	XF69	66
w	Medium Grey Green - semi gloss	XF71	78
x	Brown Glaze - semi gloss	X22(x5) + XF52(x1)	135(x5) + 29(x1)
y	Lilac - semi gloss	X16(x1) + XF52(x1) + XF2(x2)	-
z	Dark Grey Green - semi gloss	XF65	116

Note: Apply clear varnish to achieve the desired gloss or semi-gloss finish. *See our website hints and tips for painting wood.

D.V

D.Va & D.Va (OAW)

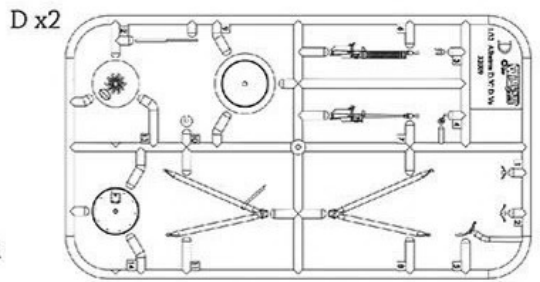
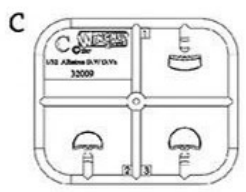
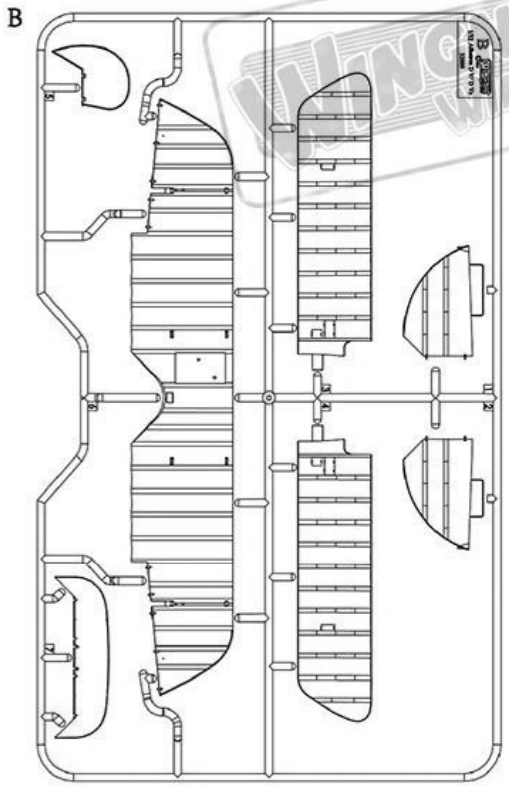
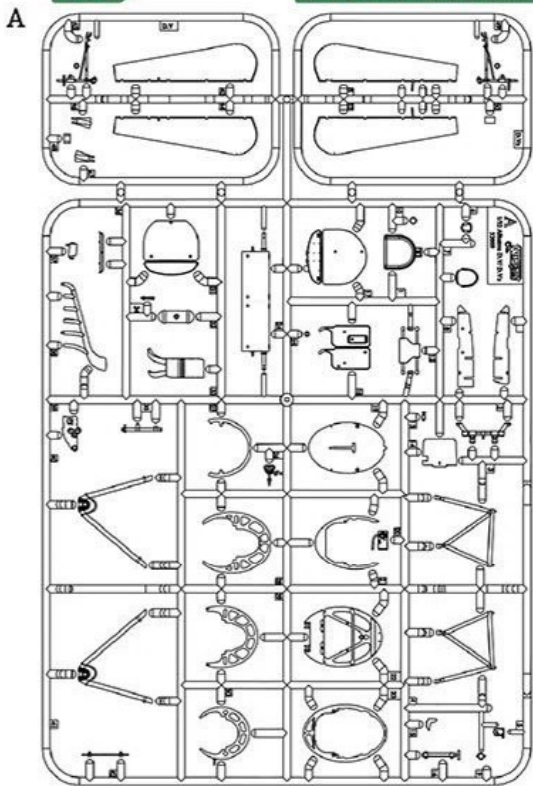

■ = Not Used

Photo Etch

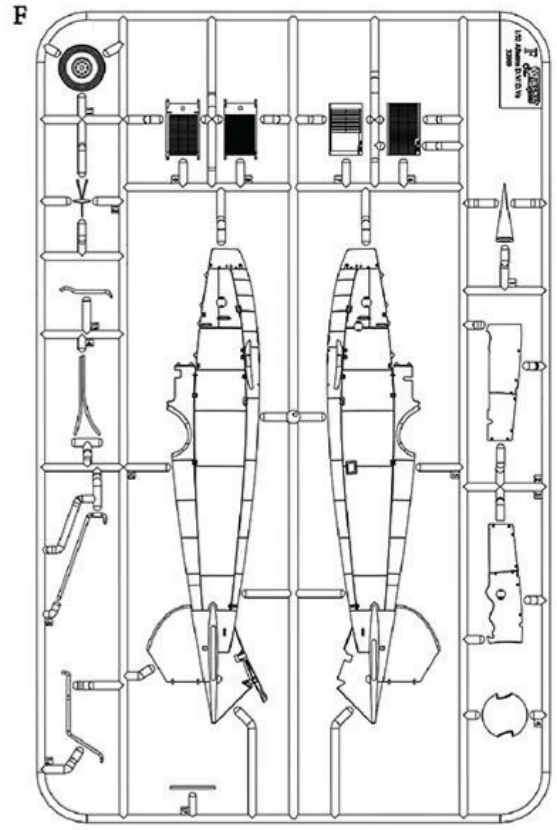
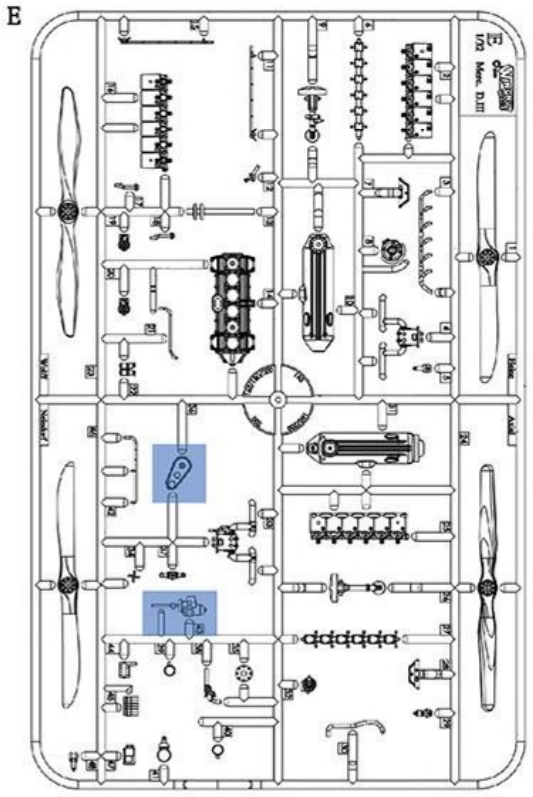
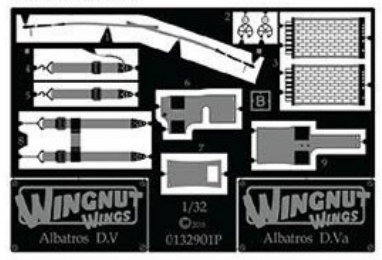

+ version specific decals

1 COCKPIT

! Please see our website for hints and tips on painting realistic wood colours.

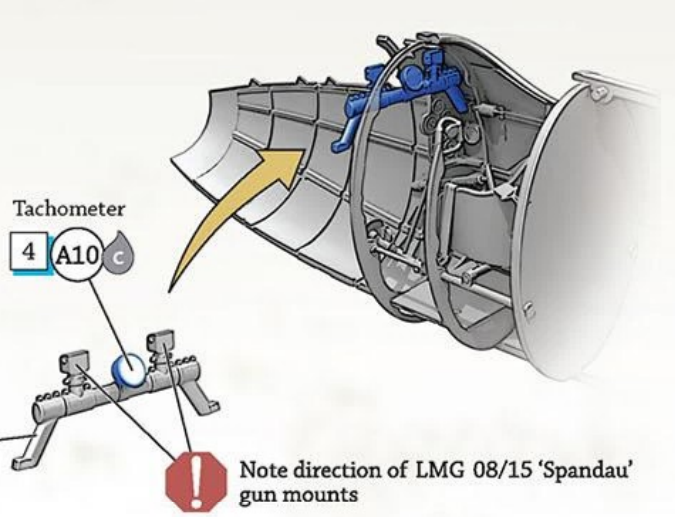
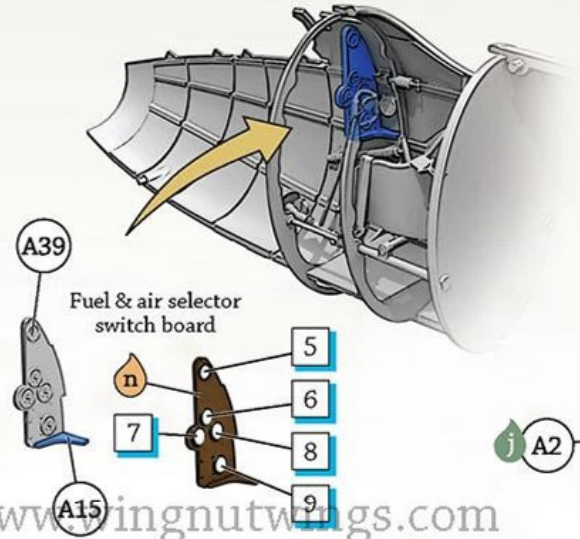
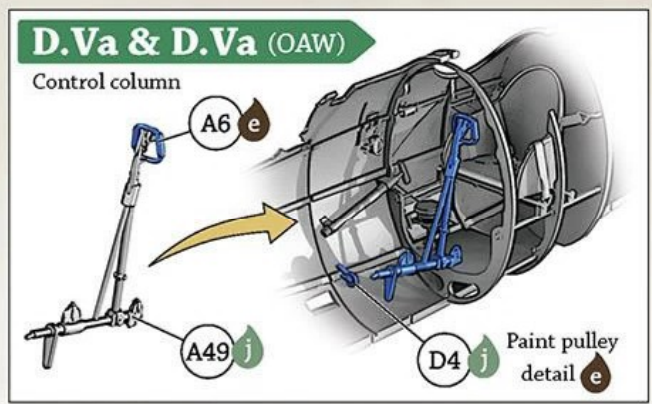
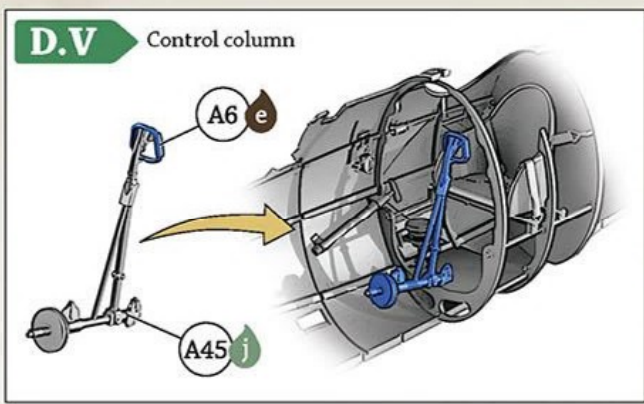
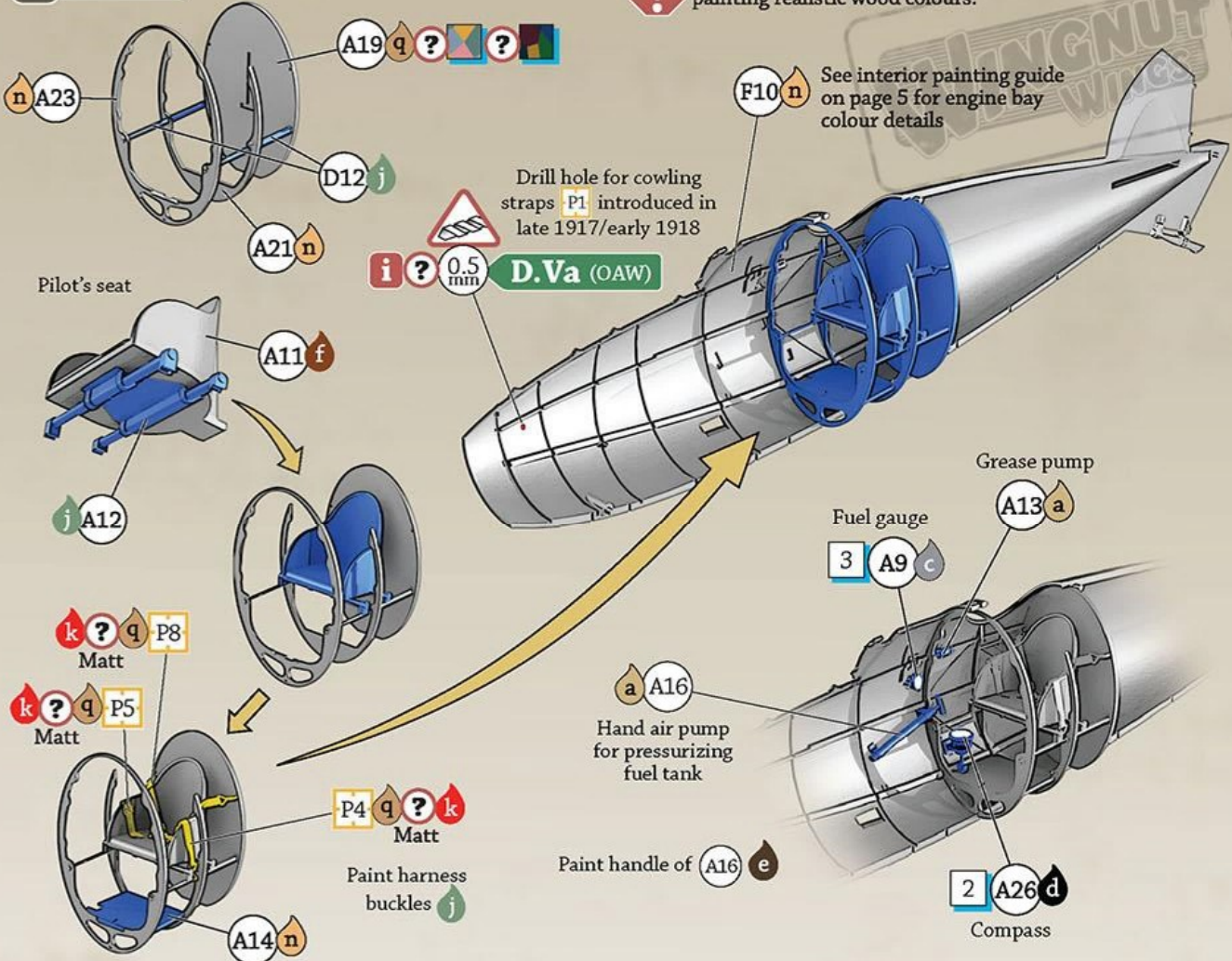

2 COCKPIT continued

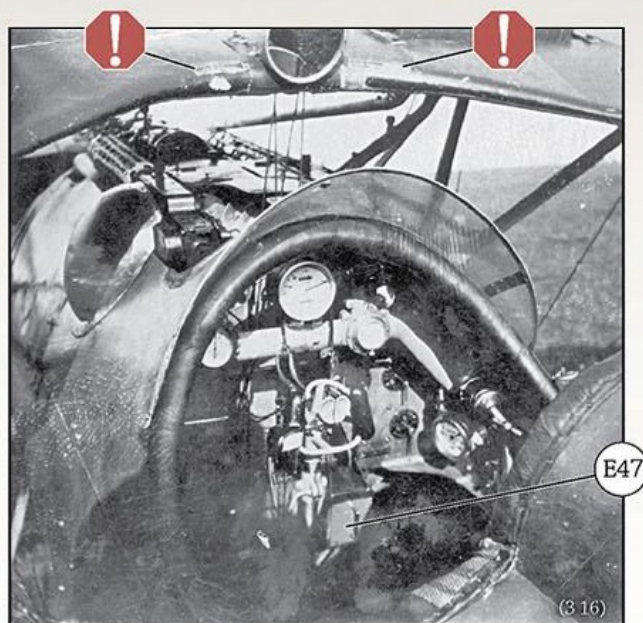
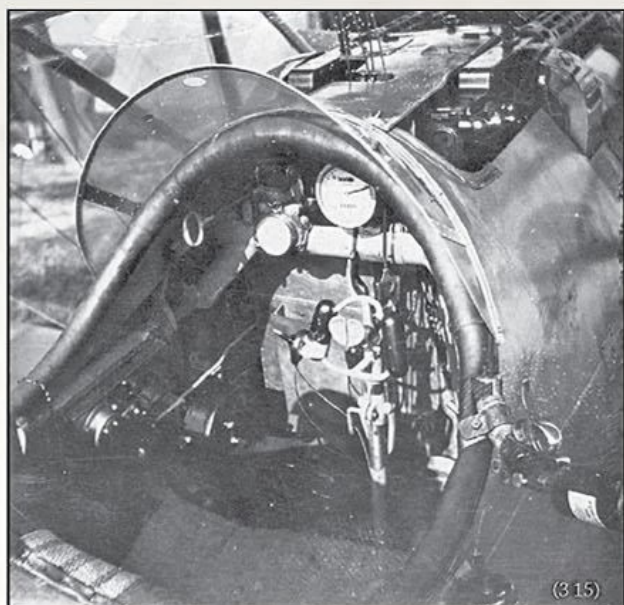
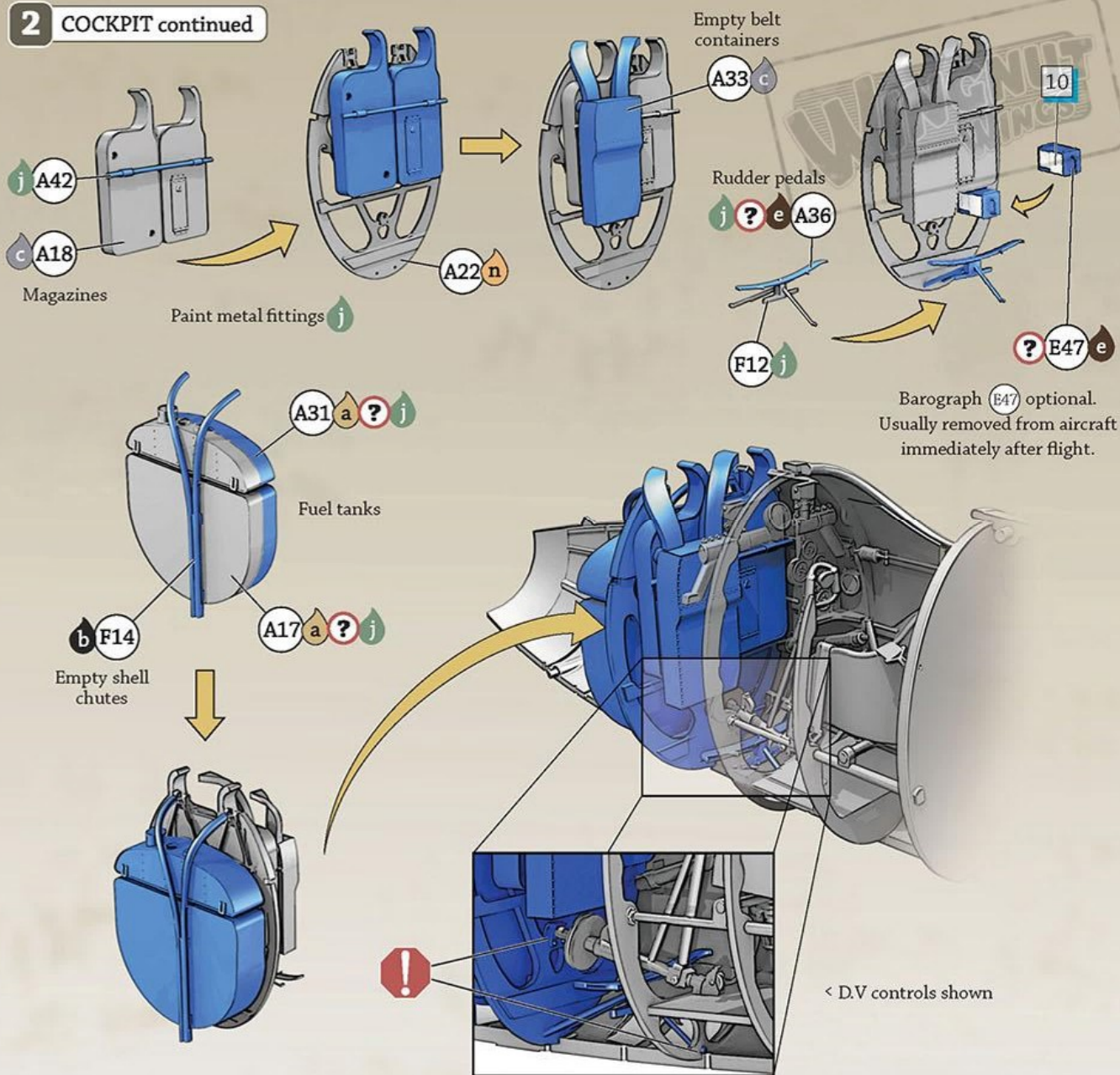

Cockpit details from a Royal Prussian Jasta 31 Albatros D.V. Note the pilot's goggles dangling from the all important tachometer attached to the center of the LMG 08/18 'Spandau' mount, with an altimeter to the left and clock to the right. Also note the barograph (E47) suspended below the instrument board, mirror (E4), D.V specific headrest (F1) & aileron control cables, the Eisfeld flare gun attached to the right of the cockpit and the data plates attached to the rear of the top wing cut out.

(0443-069)



Factory fresh very early production Albatros D.V 1146/17 is from the 1st production order for 200 D.V placed in April 1917 (numbers 1000/17 to 1199/17). Note the large D.V headrest, empty ammunition belt chute fairing (A7), aileron control horns & fairings, 2 line weight table painted on the side of the fuselage under the cockpit and lack of cowling retaining straps (P1). The fuselage is varnished plywood, the rudder is unbleached doped linen while the wings and tailplane are finished in medium grey green (w/o) mauve or dark grey green (z/y) lilac camouflage paint.

(11)



Albatros D.Va with the silver fuselage unit colour of Royal Bavarian Jasta 34b and Robert Ritter von Greim's personal marking of 2 red bands. Although the serial number is unconfirmed this aircraft appears to be from the 1st production order for 262 D.Va placed in August 1917 (numbers 5165/17 to 5426/17). Note the D.Va aileron control cables visible behind each interplane 'V' strut, which do not feature the additional wing bracing brackets. The wings and tailplane are covered in 5 colour lozenge fabric.

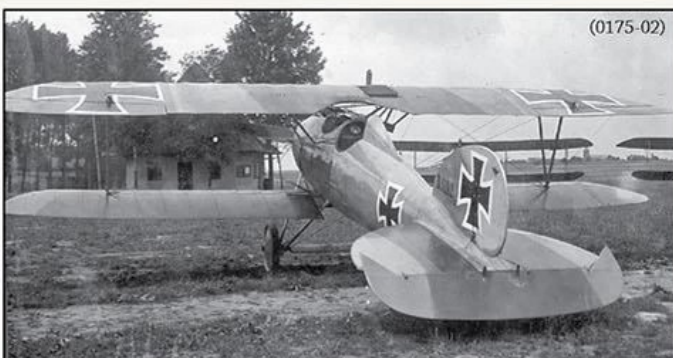

(0175-02)

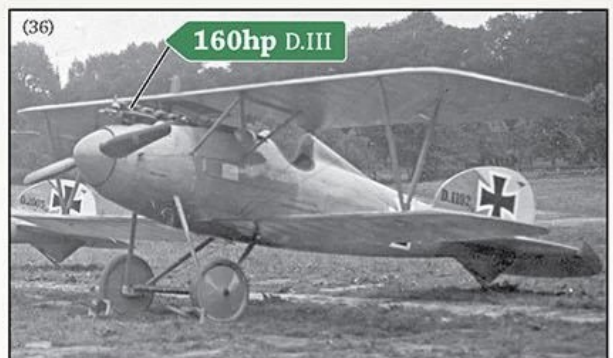

(36)

160hp D.III

Factory fresh very early production Albatros D.V 1192/17 is from the 1st production order and was photographed here in July 1917. Note the 160hp Daimler-Mercedes D.III engine, headrest, empty ammunition belt chute fairing (A7) and the assembly & rigging instructions doped to the port side of the fuselage.

3 DAIMLER-MERCEDES 160hp D.III ENGINE

! 160hp, 180hp & 200hp engines could be swapped between airframes.

D.V

1000/17 to 1199/17
1962/17 to 2361/17
4403/17 to circa 4470/17

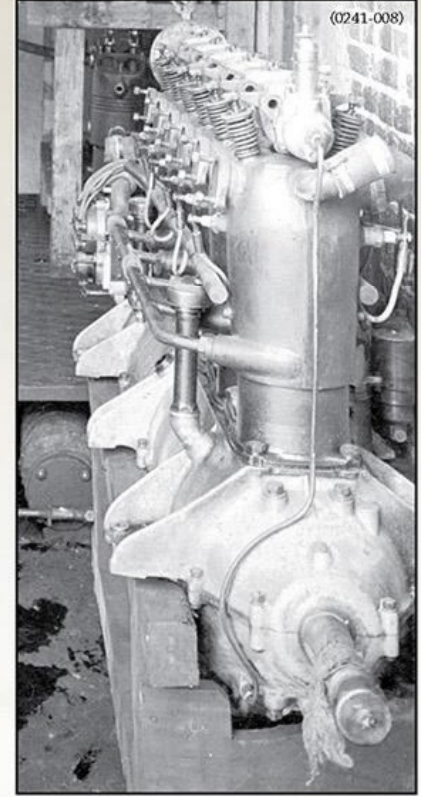
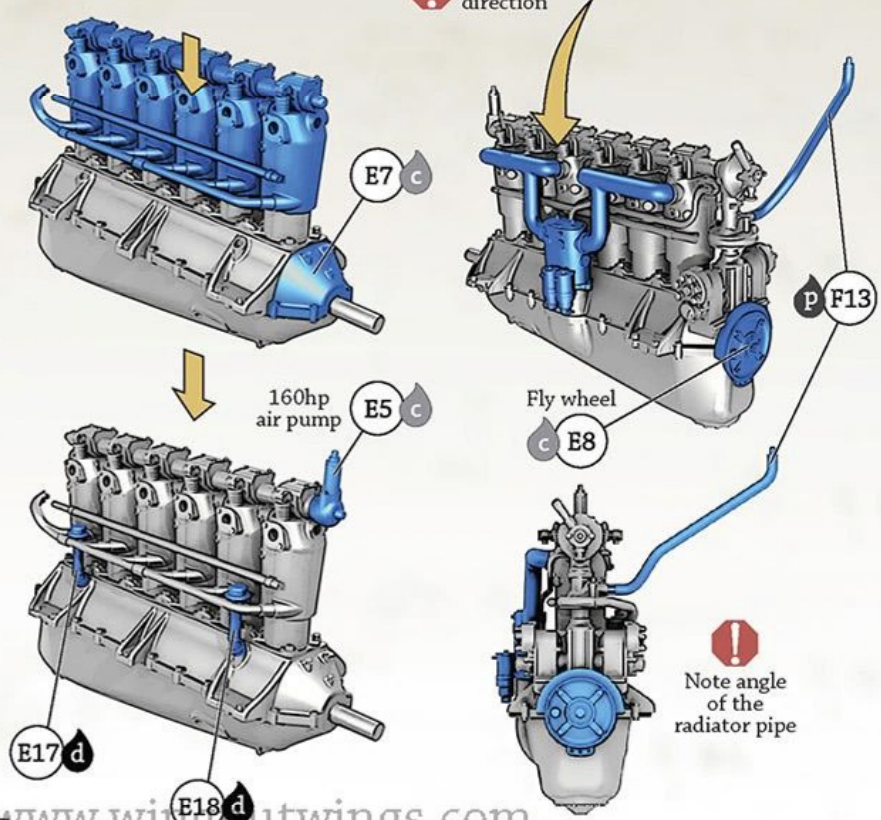
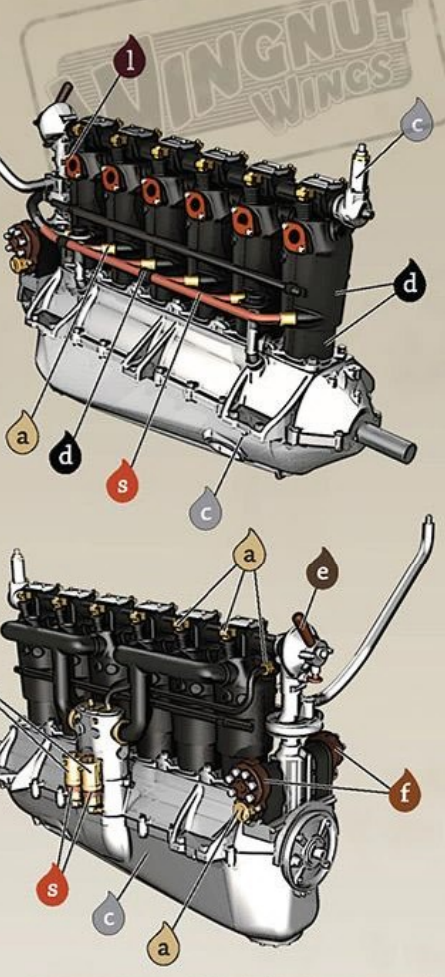
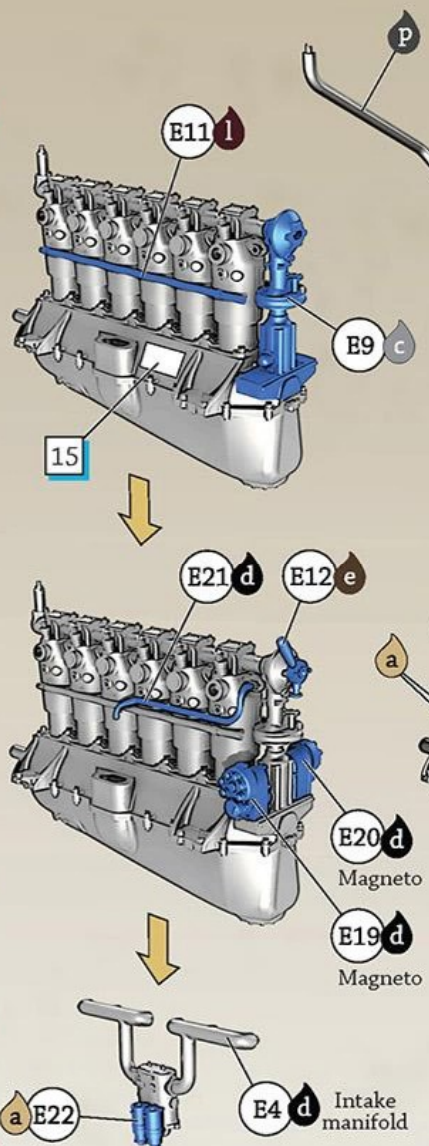
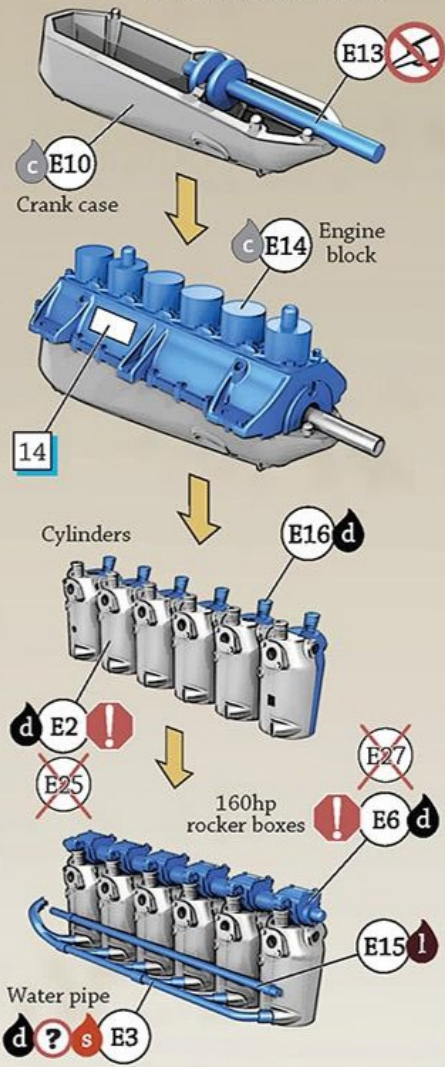

160hp Daimler-Mercedes D.III engine under going maintenance. This is the most common type of engine fitted in the Albatros D.V. Note the small cylindrical air pump (E5) at the front and on the right side of the engine the exposed water pipe (E3).

4 DAIMLER-MERCEDES 180hp D.IIIa & 200hp D.IIIaü ENGINE

D.V Circa 4470/17 to 4702/17
(4665/17 & 4675/17 = 160hp)

D.Va & D.Va (OAW)

! 160hp, 180hp & 200hp engines could be swapped between airframes.

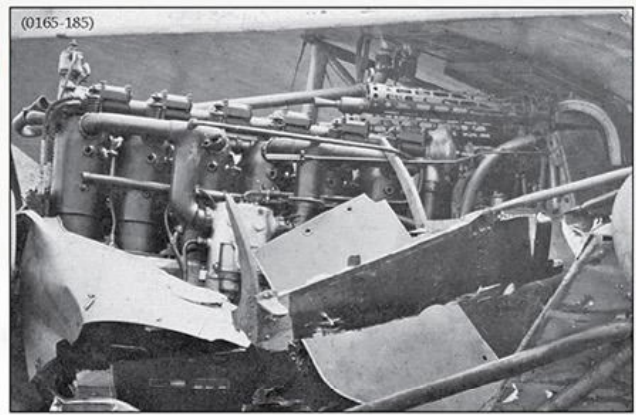
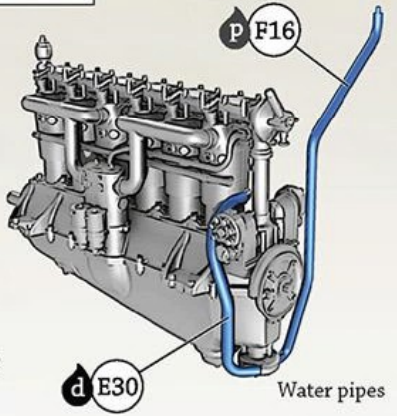
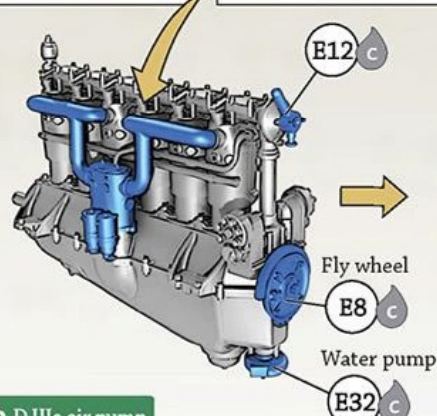
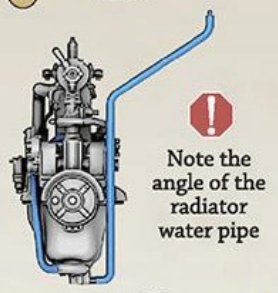
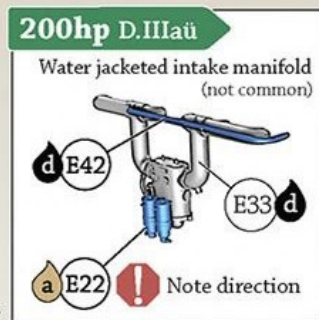
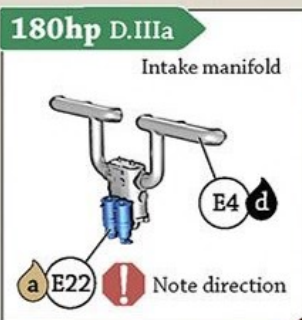
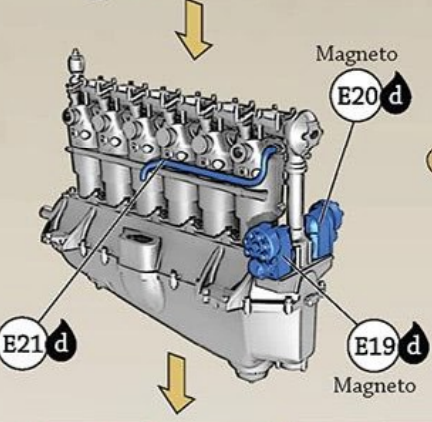
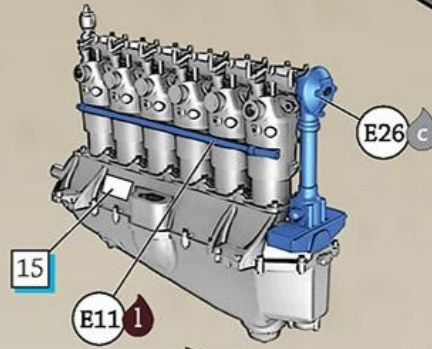
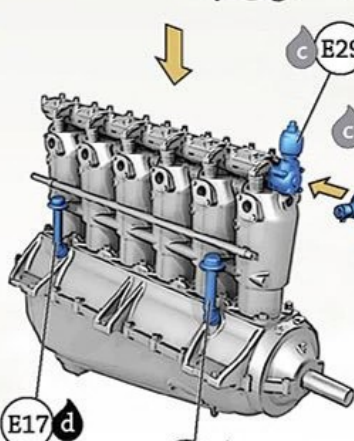
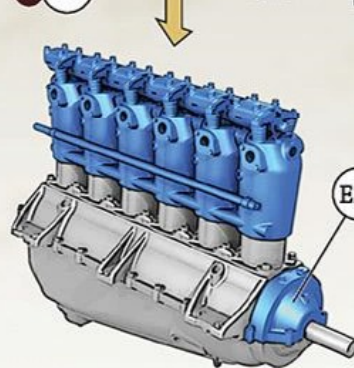
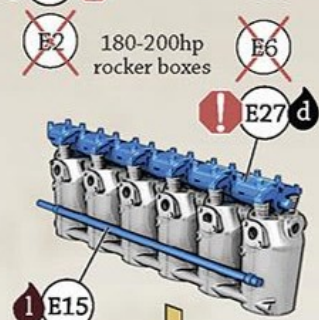
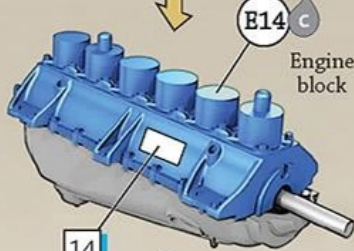
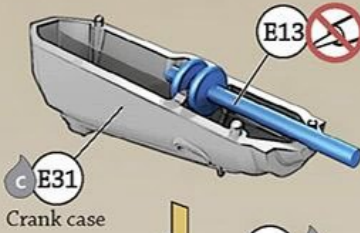

The 180hp Daimler-Mercedes D.IIIa of this crashed Royal Prussian Jasta 62 Albatros D.Va has the water jacketed intake manifold more commonly associated with the 200hp D.IIIaü engine.

180hp D.IIIa

P1

(0810-016)



Long serving Albatros D.V 2359/17 is from the 2nd production order for 400 D.V placed in May 1917 (numbers 1962/17 – 2361/17) and was serving with Royal Bavarian Jasta 23b by the time Otto Hohmuth was captured on 6 March 1918. By this time the original 160hp Daimler-Mercedes D.III engine had been replaced by the 180hp Daimler-Mercedes D.IIIa seen here, the original 'V' struts (D8) had been reinforced with braces (D11) and had engine cowling retaining straps (P1) retrofitted. It is seen here after being repainted in RFC markings and having its armament removed. An anemometer was fixed to the starboard 'V' strut but has been removed by its captors and replaced with a single pitot tube on the top wing.

180hp D.IIIa

P1

(446)

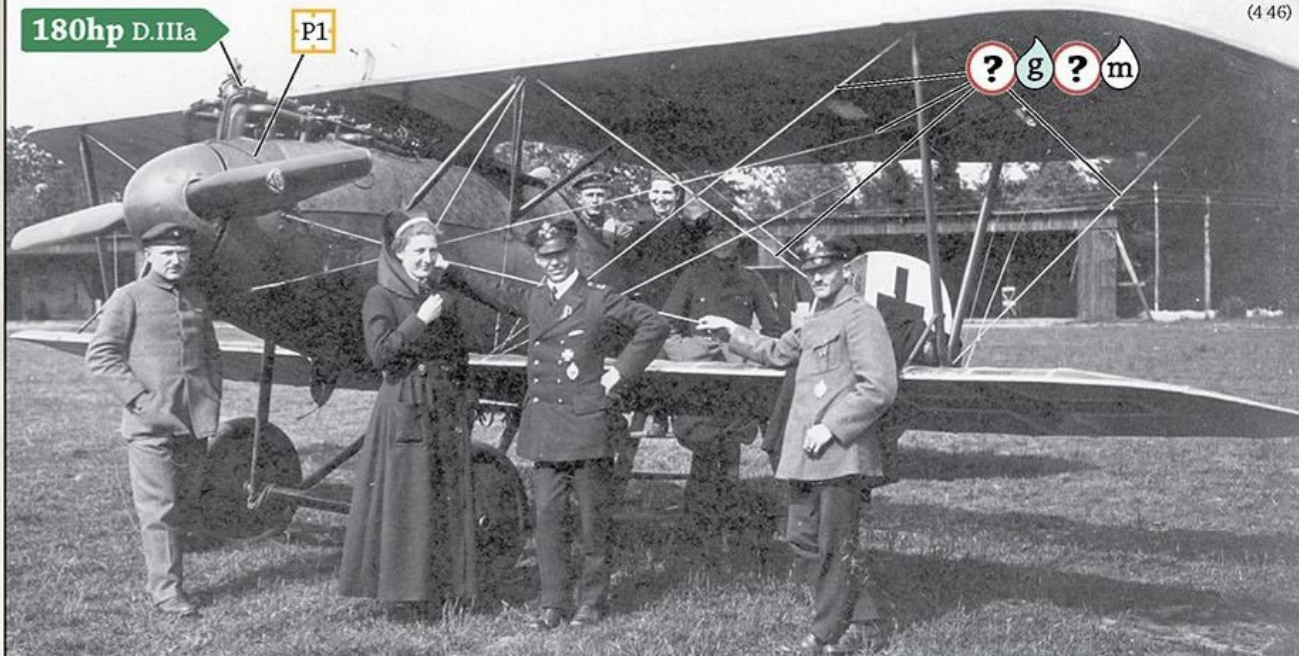

Long serving Johannisthal built Albatros D.Va '76' in service with a Marine Feld Jasta in mid to late 1918. Note the 180hp Daimler-Mercedes D.IIIa engine with water jacketed intake manifold, modified 'post March 1918' balkenkreuz markings and the additional wing strut bracing brackets on the interplane 'V' struts. Also note the mottled camouflage finish on the engine cowlings and the bomb rack fitted under the fuselage for 12.5kg PuW bombs. The very pale rigging wires are unusual and have probably been painted light blue or white.

This Ostdeutsche Albatros Werke built Albatros D.Va (OAW) is from the final production order, but the 1st order placed with OAW, for 600 D.Va in September-October 1917 (numbers 6400/17 to 6999/17). The OAW factory distinguishing features visible in this photo are the fuselage lifting handle (F17) and wheel cover (D13). Photographic evidence available to us indicates that all OAW built D.Va left the factory covered with lozenge fabric and powered by the 180hp Daimler-Mercedes D.IIIa engine. Note the 'post April 1918' style of balkenkreuz markings.

D.Va (OAW)

P1

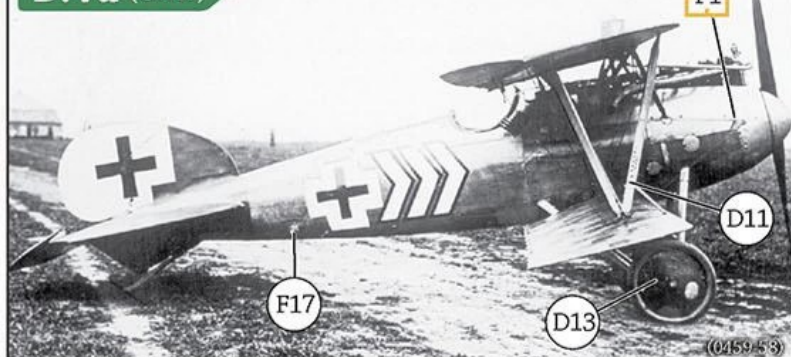

(0459-53)

5 ENGINE BAY

Paint bulkheads as per interior painting guide on page 5

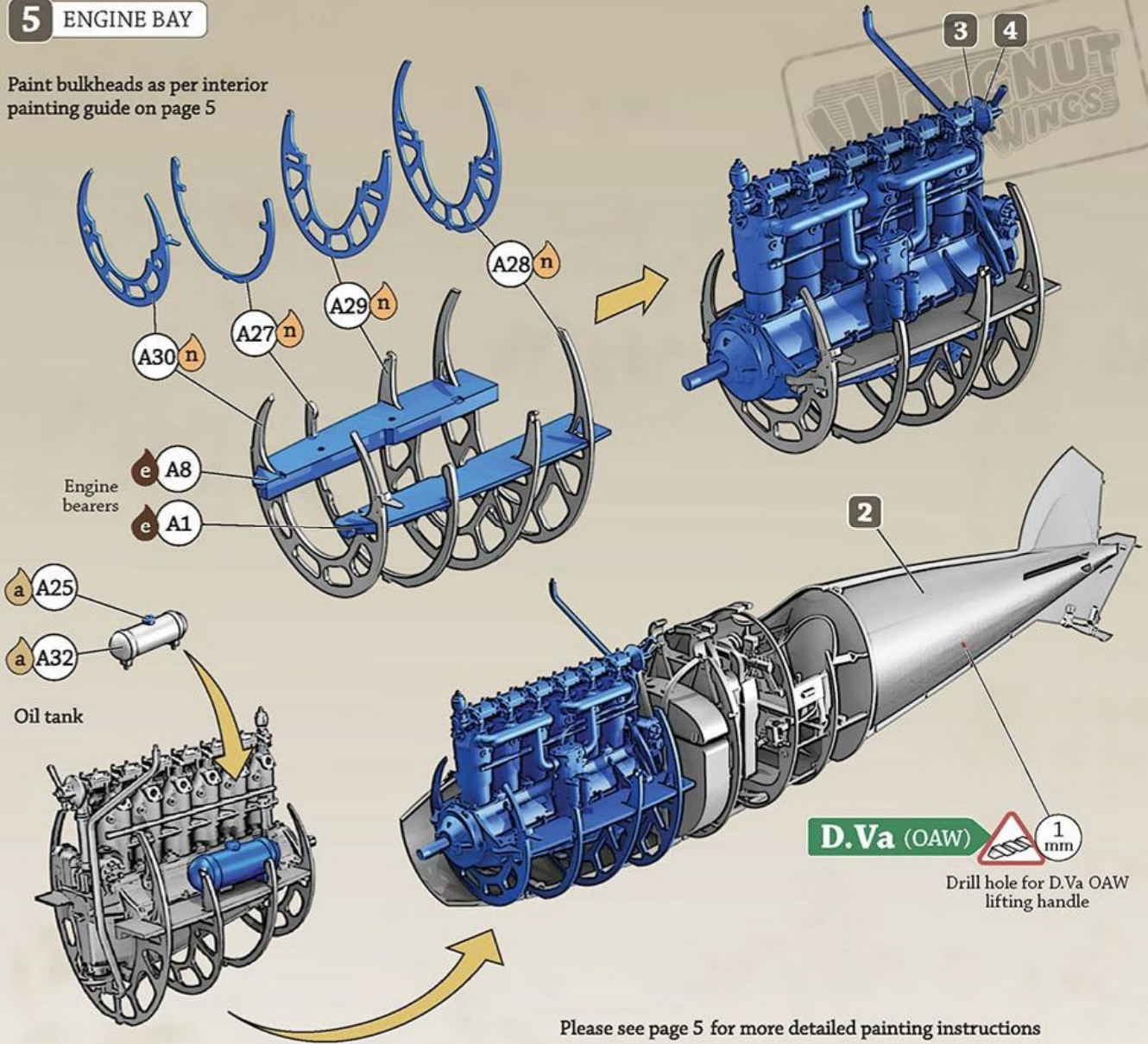

6 COCKPIT continued

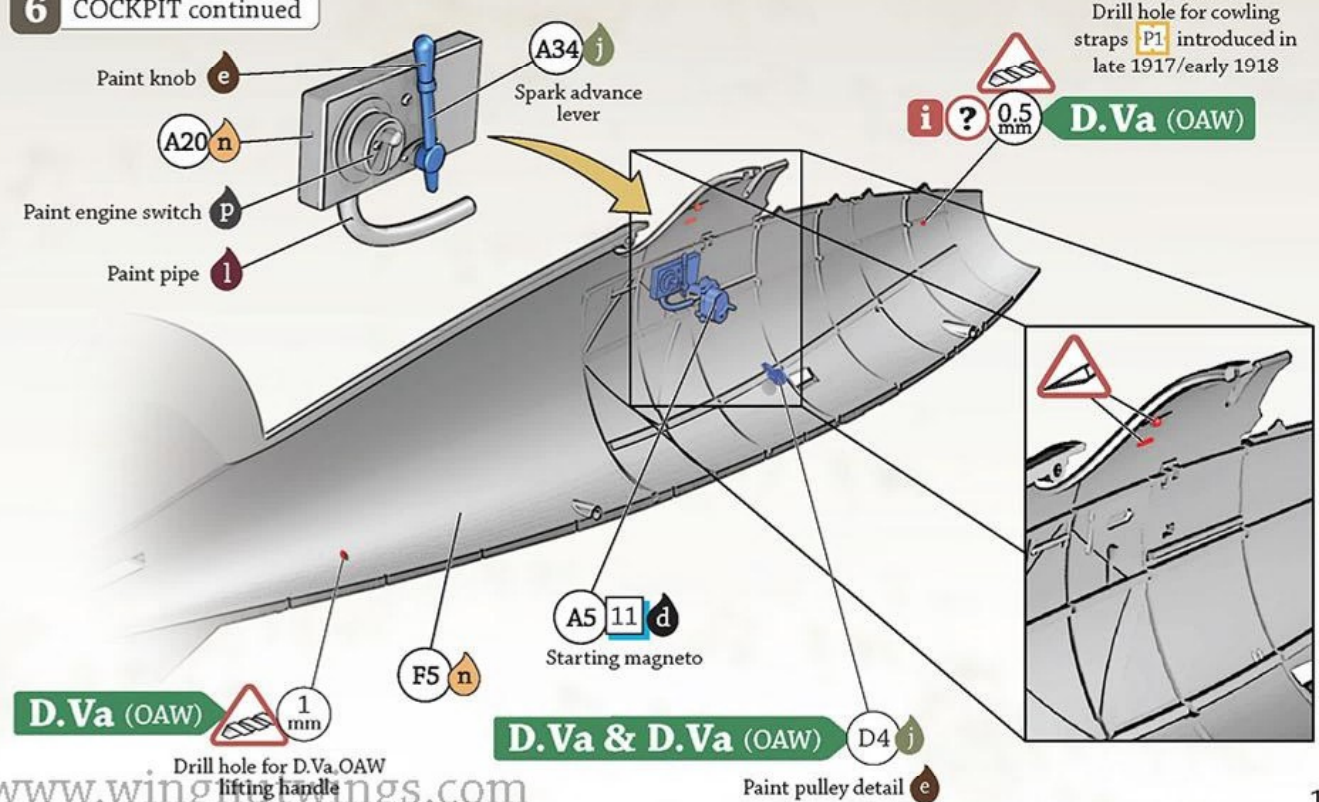

7 FUSELAGE ASSEMBLY AND TAILPLANE

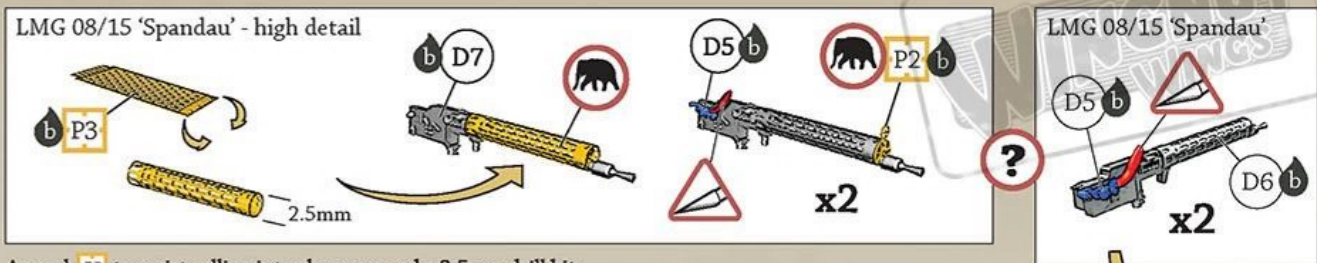

Anneal P3 to assist rolling into shape around a 2.5mm drill bit.

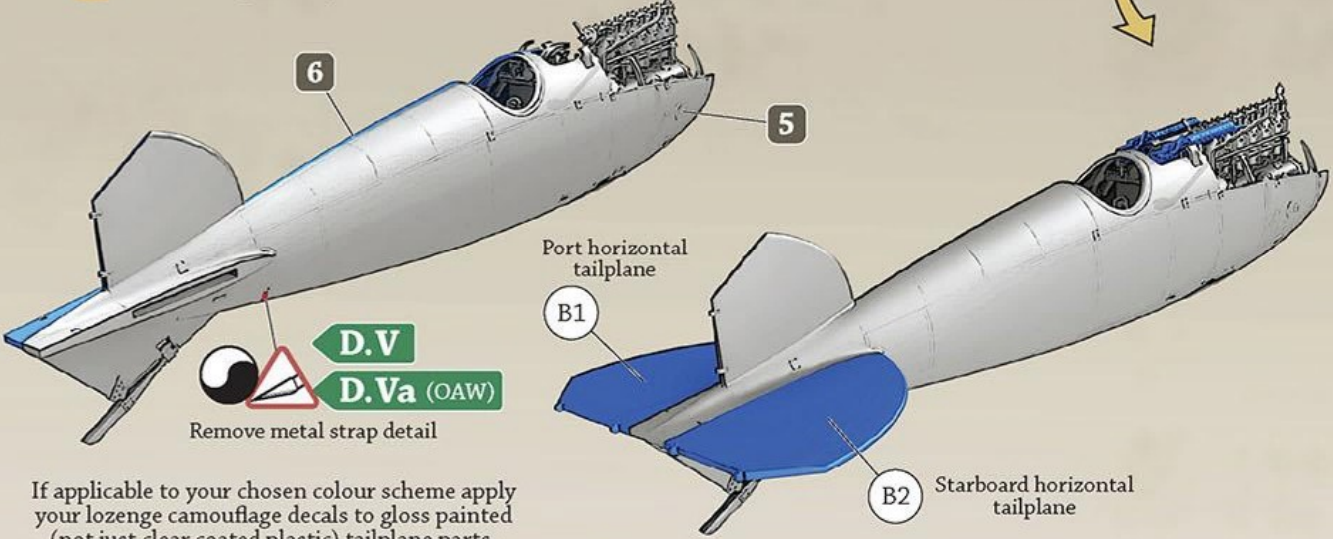

If applicable to your chosen colour scheme apply your lozenge camouflage decals to gloss painted (not just clear coated plastic) tailplane parts.

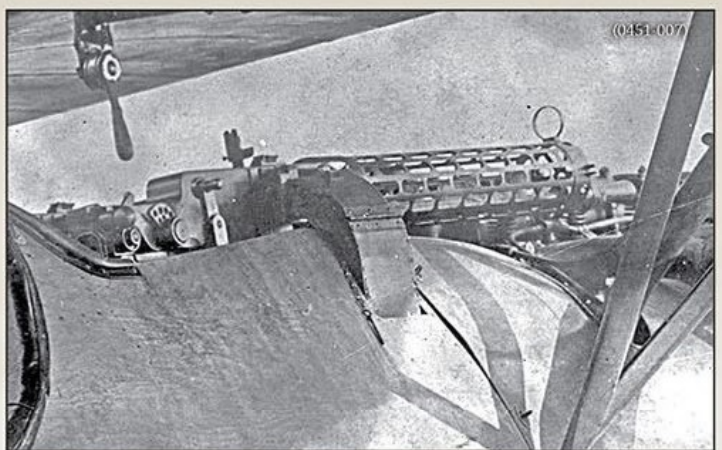
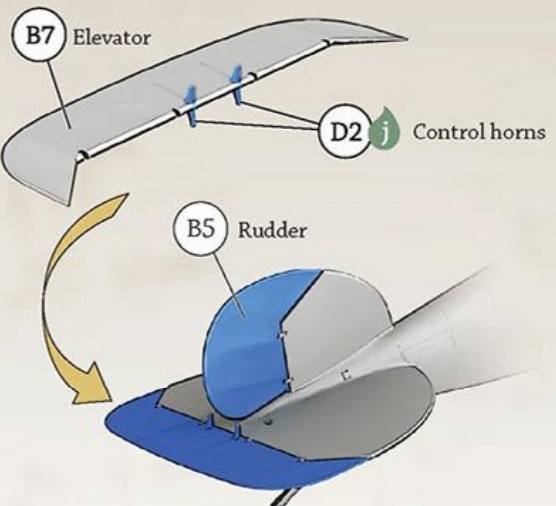

LMG 08/15 'Spandau' detail from an unidentified Johannisthal built Albatros D.Va. Note the lever attached to the top wing for adjusting the radiator shutters.



7 victory ace Helmut Dilthey's Royal Saxon Jasta 40 Albatros D.Va features reinforced 'V' strut wing brackets (D11), 5 colour lozenge fabric covering and modified 'post March 1918' balkenkreuz markings. Note the mirror (E39) attached to the top wing cut out.

8 FUSELAGE DETAILS

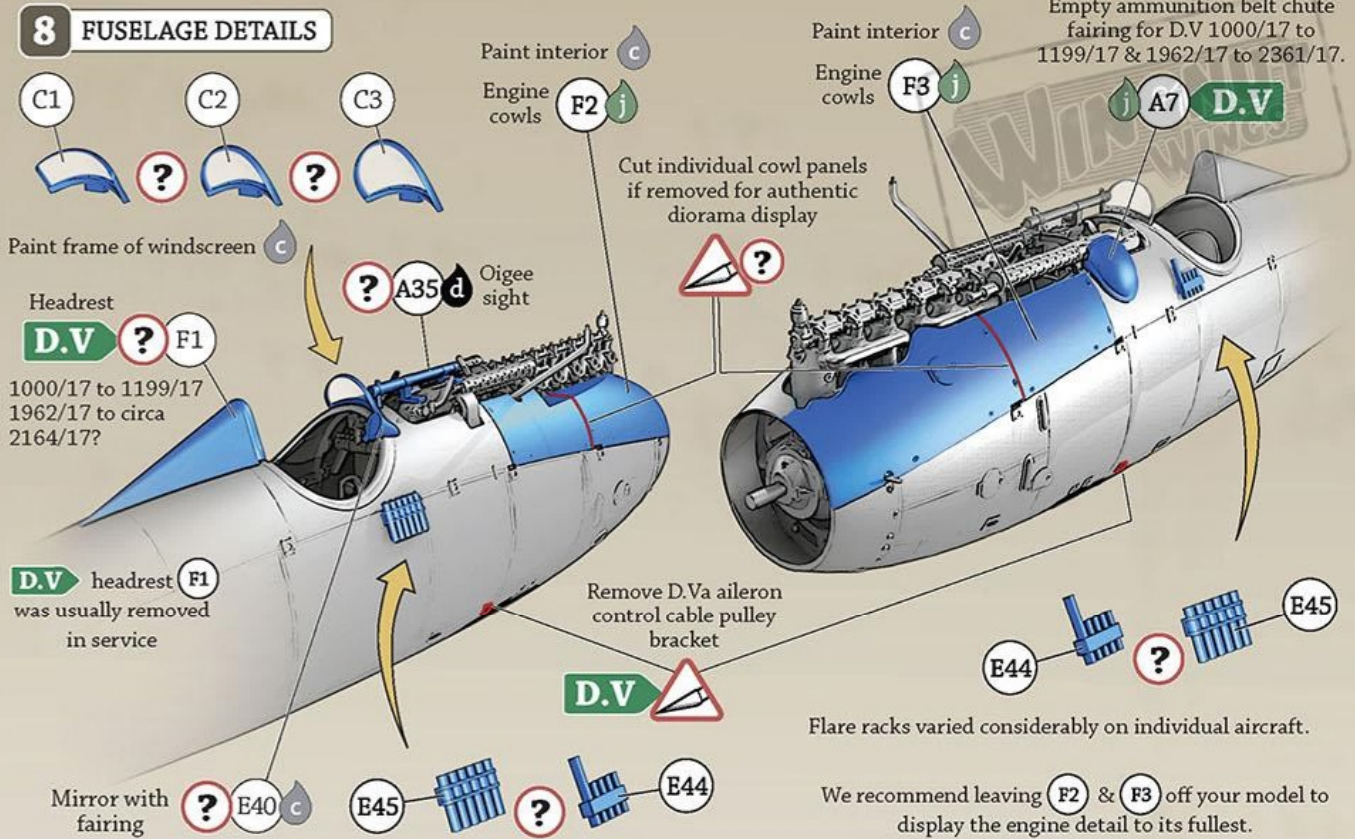

> 62 victory ace Ernst Udet sits in a relatively new unidentified early production Albatros D.V (not late production 4476/17) which conveniently shows the empty ammunition belt chute fairing (A7) which was found on D.V from the 1st production order placed in April 1917 (numbers 1000/17 to 1199/17) and 2nd production order placed in May 1917 (numbers 1962/17 to 2361/17). The headrest (F1) is only found on the D.V and were usually removed in service to allow more head movement for improved visibility and appear to have been deleted from production aircraft sometime after 2264/17. Note the unusual scoop at the rear of the radiator and 'colourful' safety harness straps.



Late production Albatros D.V 4640/17 'R' is from the 3rd and final production order for 300 D.V placed in July 1917 (numbers 4403/17 to 4702/17). The lack of the empty ammunition belt chute fairing (A7) is a feature of Albatros D.V from this production order and all D.Va and D.Va (OAW). Note the 180hp Daimler-Mercedes D.IIIa engine, lozenge fabric covering and unique position of the anemometer on the bottom wing. The aircraft in the background is a Gotha G.V to which Albatros D.V 4640/17 'R' served as escort.

9 BOTTOM WINGS

If applicable to your chosen colour scheme apply your lozenge camouflage decals to gloss painted (not just clear coated plastic) wing parts.

Starboard wing

B4

8

B3 Port wing



< Wing detail from Max Kahlow's Royal Bavarian Jasta 34b Albatros D.V showing where the wings attach to the wooden wing root fixed to the fuselage. Note the rigging attachment points and small size of the turnbuckles.

10 STRUTS

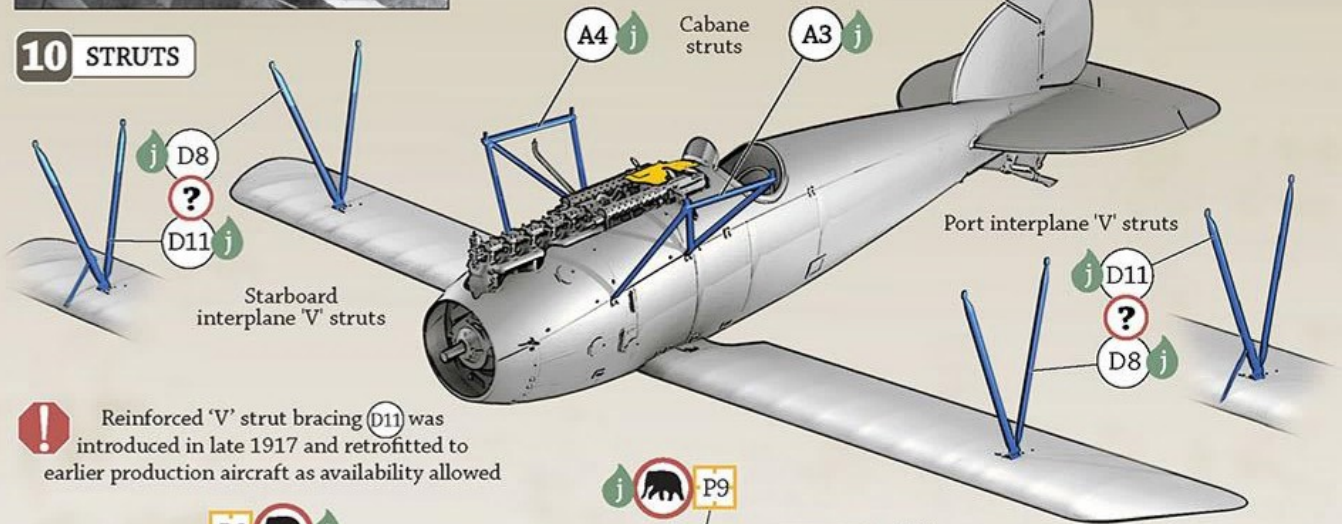

! Reinforced 'V' strut bracing (D11) was introduced in late 1917 and retrofitted to earlier production aircraft as availability allowed

D.V

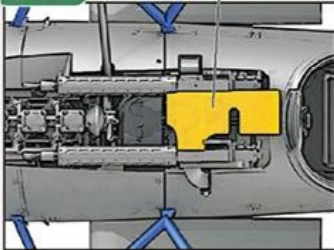

D.Va & D.Va (OAW)

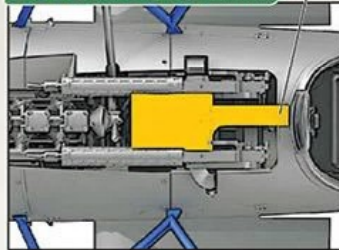

D.V D8

D.Va D8

D.Va D11

D.Va (OAW) D11

5165/17 to 5426/17 & 5600/17 to 5849/17

7000/17 to 7549/17

(Greg Van Wyngarden)



< Wing strut detail from Ernst Udet's Royal Prussian Jasta 37 late production Albatros D.V 4476/17 photographed in late 1917 showing the interplane 'V' struts fitted with additional wing bracing brackets (D11) which are more commonly associated with the D.Va. These brackets were introduced in late 1917 in an effort to prevent the bottom wing twisting on its single spar attachment and failing in flight and were retrofitted to earlier production aircraft as availability allowed.



γ Wing strut detail from Rudolf Clauß's Royal Prussian Jasta 29 early production Albatros D.Va 5390/17 photographed in December 1917 shows the original interplane 'V' struts (D8) (without additional wing bracing brackets).

11 TOP WING AND RADIATOR OPTIONS

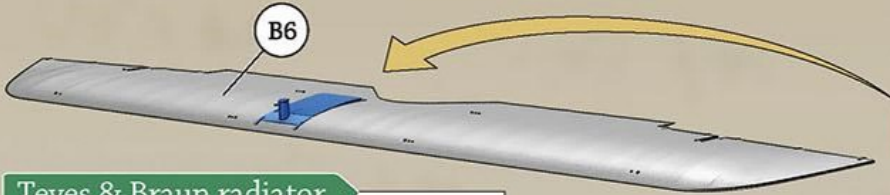

Teves & Braun radiator



Daimler-Mercedes radiator



Teves & Braun radiator



Daimler-Mercedes radiator

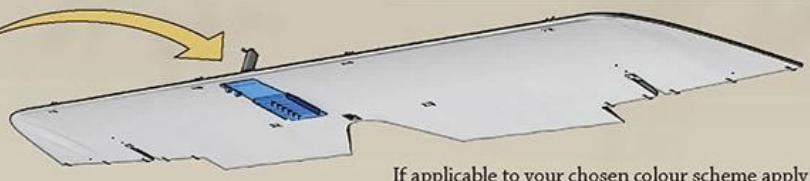

If applicable to your chosen colour scheme apply your lozenge camouflage decals to gloss painted (not just clear coated plastic) wing parts.



Unpainted aluminium Teves & Braun radiator detail from Manfred von Richthofen's Royal Prussian Jasta 11 Albatros D.V photographed on 6 July 1917.



Unpainted aluminium Teves & Braun radiator detail from Robert Ritter von Greim's Royal Bavarian Jasta 34b Albatros D.Va as seen on page 6.



Daimler-Mercedes radiator detail from Albert Tybelski's Royal Prussian Jasta 19 Albatros D.V 2104/17. Note the mirror (E39).



Daimler-Mercedes radiator detail from Rudolf Clauß's Royal Prussian Jasta 29 Albatros D.Va 5390/17 photographed in December 1917.

12 AILERONS

D.V

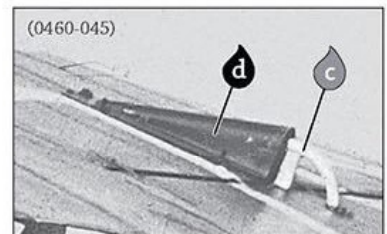
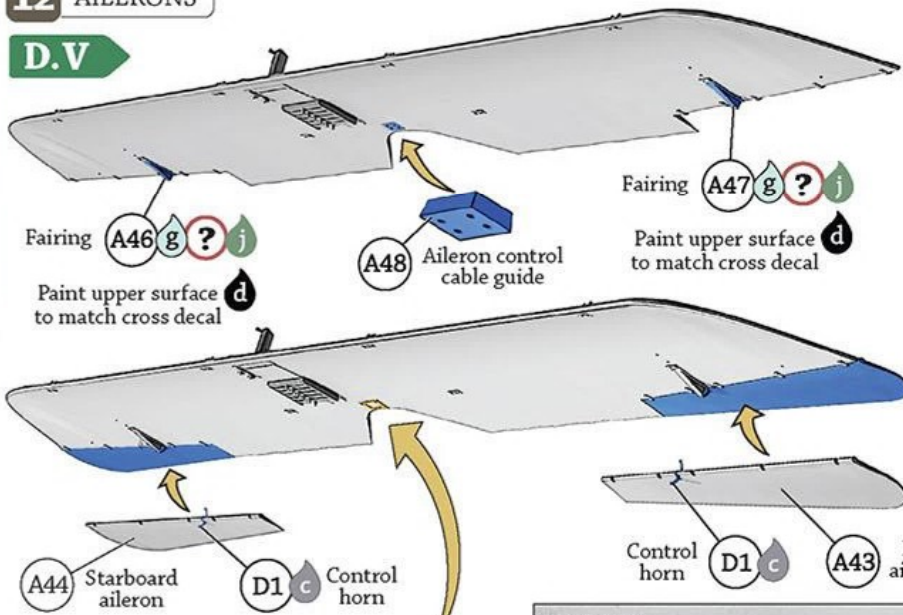

Detail shot of the D.V aileron control horn and cable fairing. The upper surface of this fairing has been painted black to match the cross, while the lower surface would be painted light blue to match the wing. On the lozenge covered wings the lower surface would be left in its grey-green primer (j).

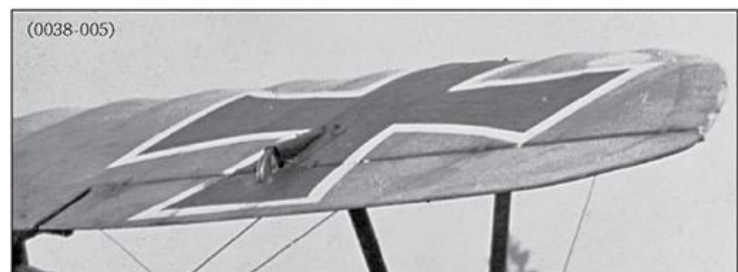
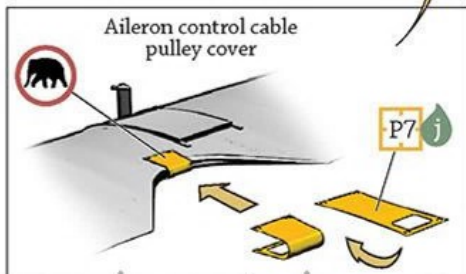

Aileron control horn and cable fairing detail from Karl Schattauer's Royal Bavarian Jasta 16b Albatros D.V

13 AILERONS continued

D.Va & D.Va (OAW)

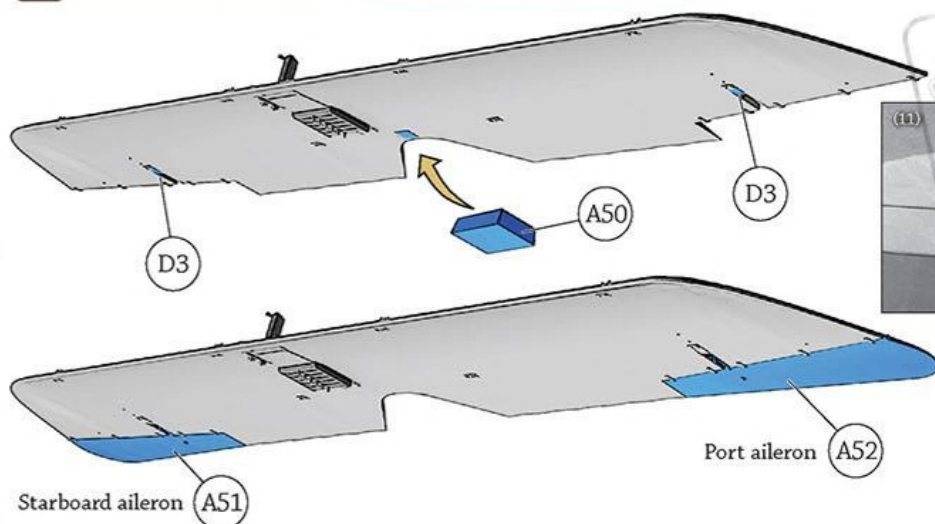

Aileron control horn detail from Robert Ritter von Greim's Royal Bavarian Jasta 34b Albatros D.Va as seen on page 6.

14 ATTACH TOP WING & UNDERCARRIAGE

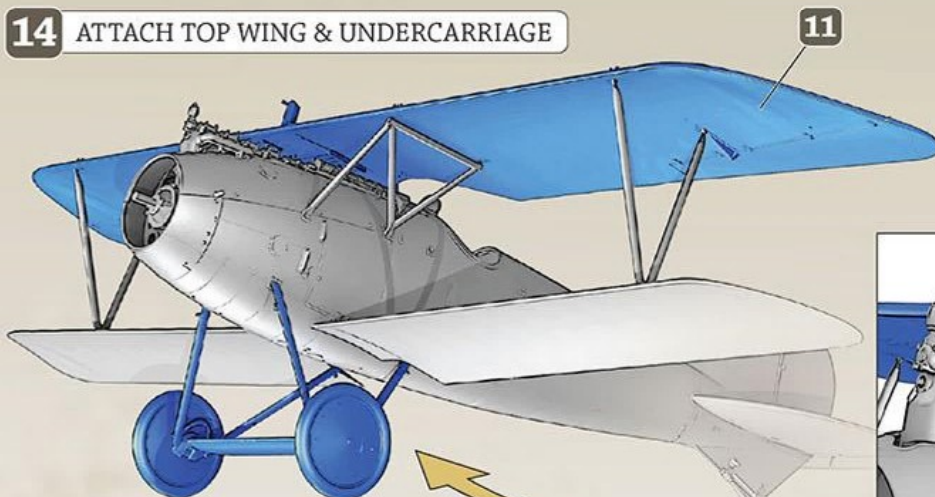

! Note position of radiator pipe

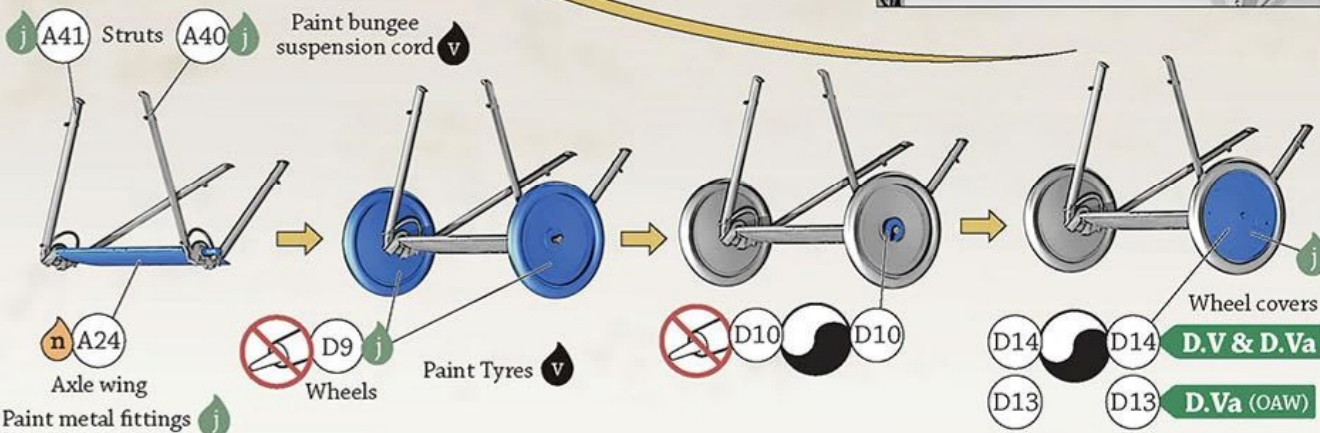
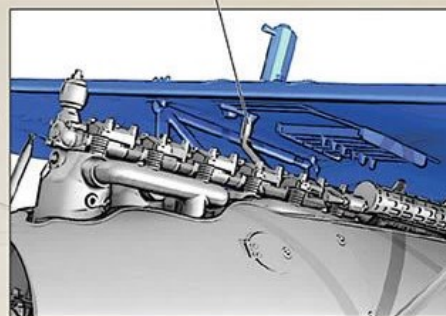

< Undercarriage detail from Albert Dietlin's Royal Prussian Jasta 41 late production Albatros D.V 4612/17 showing the common D.V & Johannisthal built D.Va style of tyre valve access & wheel cover (D14).

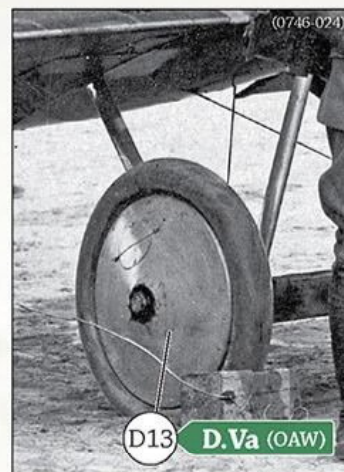

> Undercarriage detail from an unidentified OAW built Albatros D.Va showing the OAW style of tyre valve access & wheel cover (D13).

15 PROPELLER

Propellers were frequently damaged and replaced. While a photo may show a particular aircraft with a particular propeller it usually would not last very long and there is no guarantee that it would be replaced with another from the same manufacturer.

Axial E24 n & e

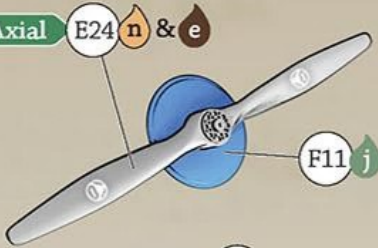

Wolff E23 n & e

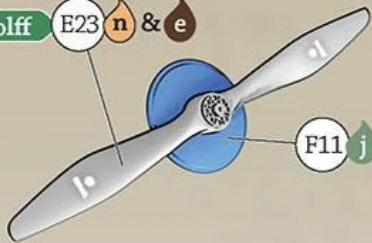

Niendorf E46 n & e



Heine E1 (not shown)

i Cowling straps introduced in late 1917/early 1918

?



D.Va (OAW)

Radiator pipe

F15 p

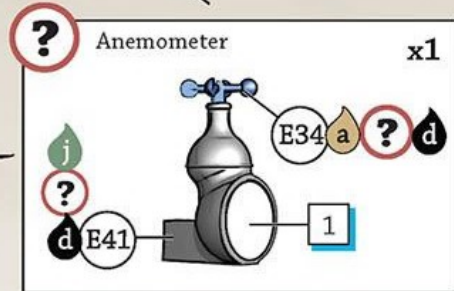
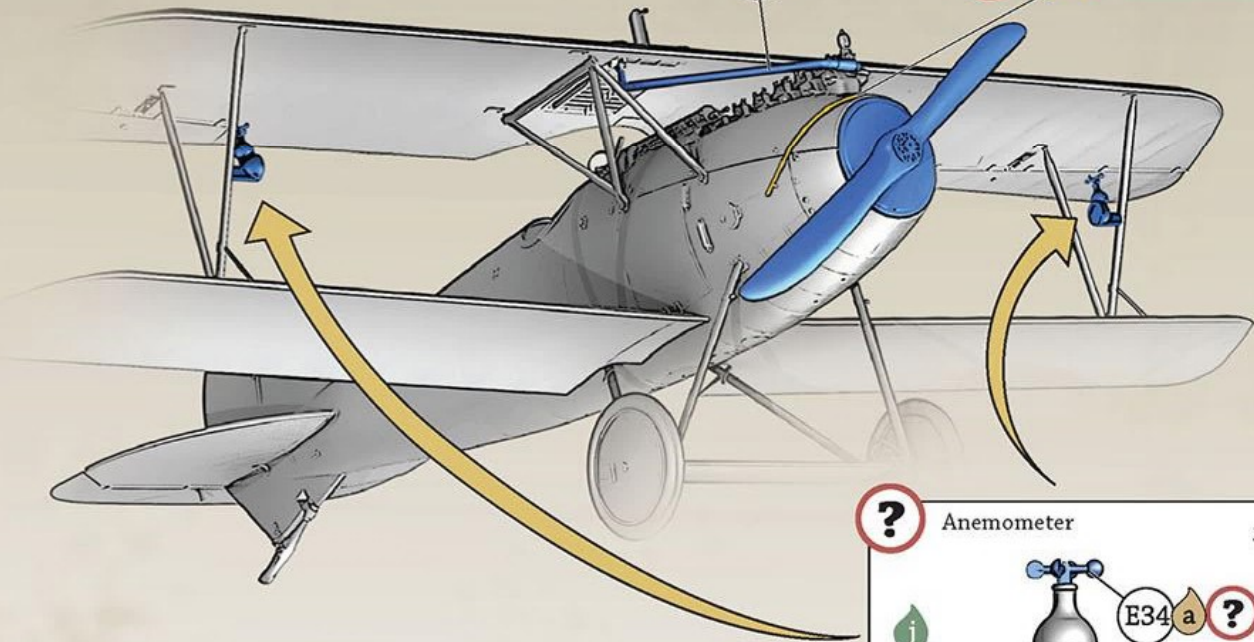

? Anemometer

x1

16 FINAL ASSEMBLY

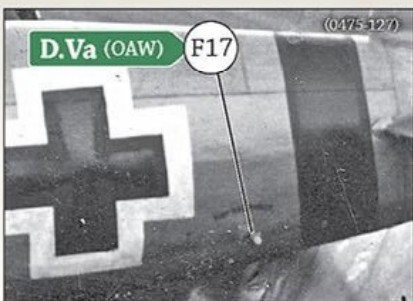

OAW style fuselage lifting handle (F17) from Albatros D.Va (OAW) 6753/17.

Exhaust

p ? 1 A38

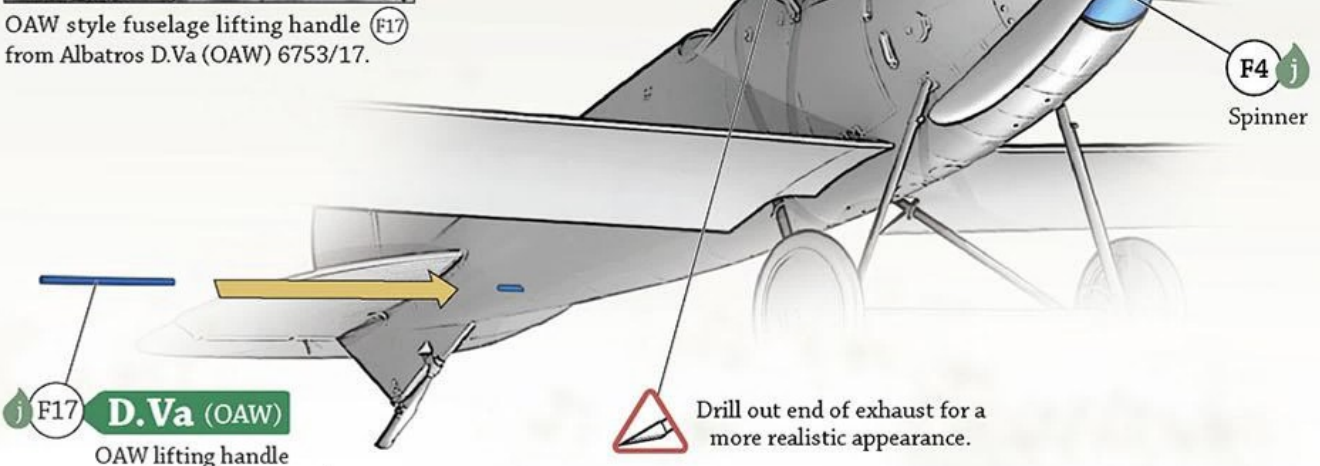

j F17 **D.Va (OAW)**
OAW lifting handle





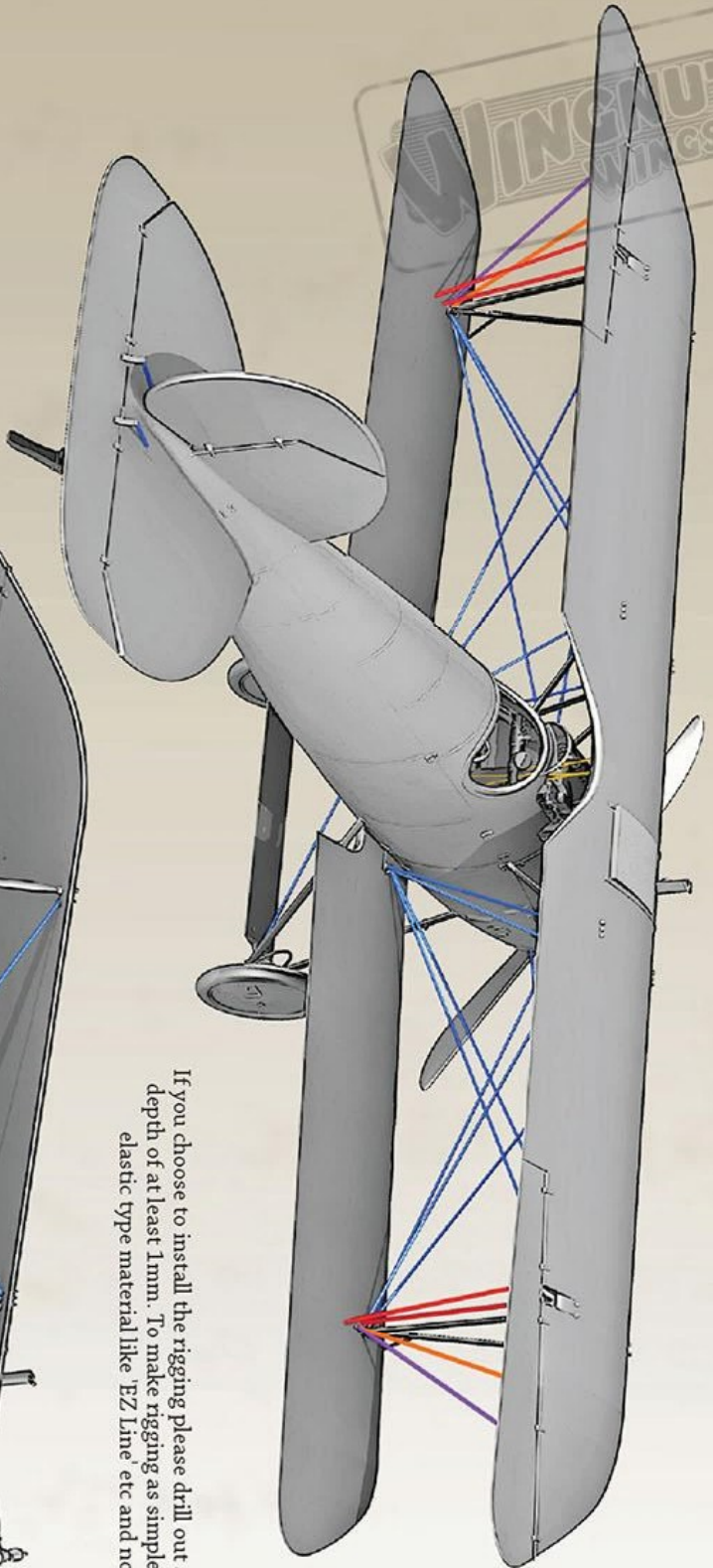

F4 **j**
Spinner

? Drill out end of exhaust for a more realistic appearance.

RIGGING GUIDE

Rigging material not supplied



- 0.15mm  Common
- 0.15mm  D.V
- 0.15mm  D.Va & D.Va (AW)
- 0.15mm  ?
- 0.15mm  ?
- 0.15mm  ?

If you choose to install the rigging please drill out all location holes with a 0.5mm drill bit to a depth of at least 1mm. To make rigging as simple as possible we recommend using stretchy elastic type material like 'EZ Line' etc and not trying to replicate any turnbuckles.

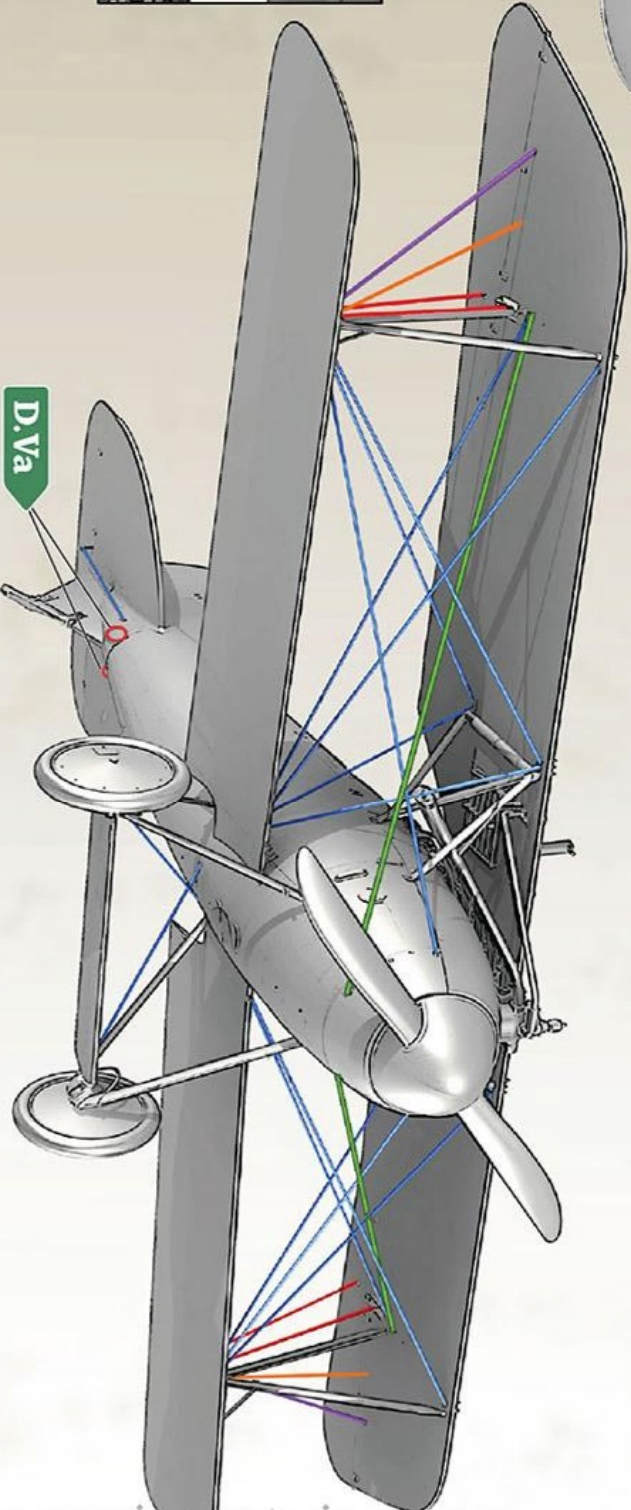

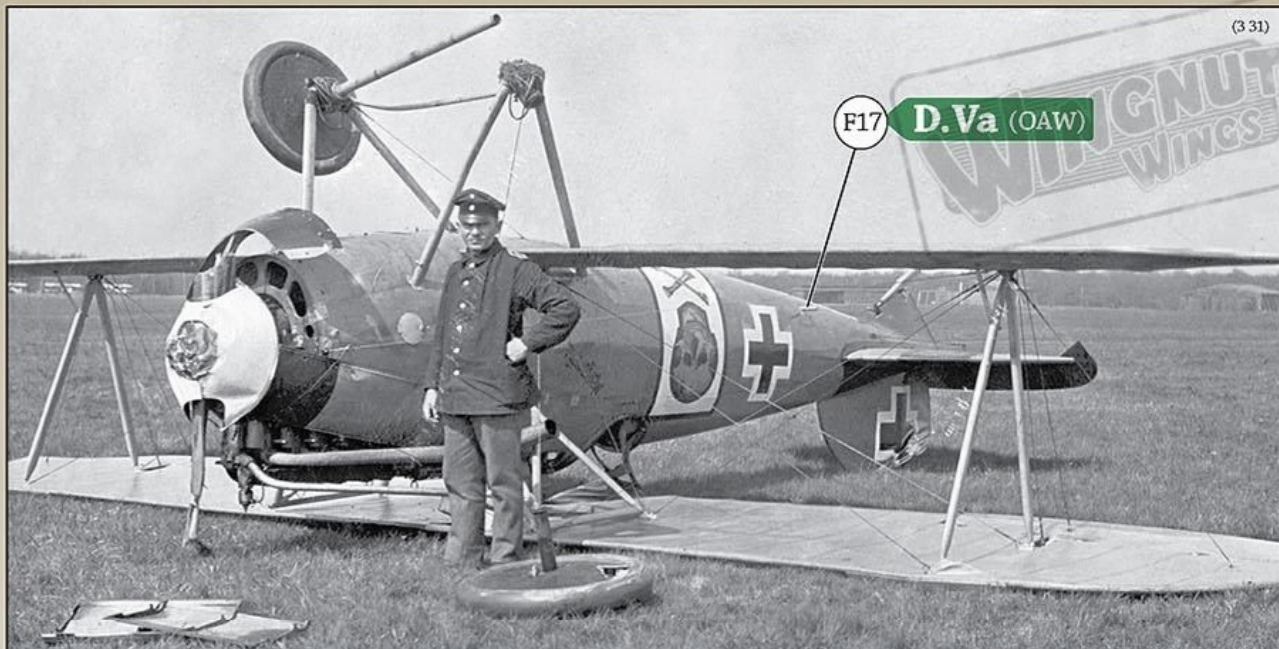

A mechanic poses in front of Hans von Goessel's crashed OAW built Albatros D.Va, the two undercarriage axle wing fairings at the bottom left of the photo possibly indicating the start of his salvage mission. Note the aileron control wires entering the upper wing, undercarriage bungee cords and OAW style lifting handle 'bar' protruding from the rear side of the fuselage. The name under the cockpit opening reads 'Margarethe'.



3-D Modelling by Mark Miller

A background in technical illustration and long term passion for modelling and early aircraft has enabled Mark to produce some of the most stunning 3D renderings of aircraft anyone is likely to see. His artwork has appeared in numerous books and publications from Cross & Cockade, Over the Front, Schiffer and Windsock amongst others.

Mark worked for Wingnut Wings from 2007 to 2009.

To see some examples of Mark's work please visit <http://www.wwi-models.org/Images/Miller/render/index.html>

Additional 3D modelling by Bryan Wall.



Profile Art by Ronny Bar

Ronny Bar developed a keen interest in airplanes from an early age, living close at the El Palomar Air Force Base in Buenos Aires. He first flew in the back seat of a T-34 Mentor trainer at the age of ten, and was soon drawing airplanes and building models: Spitfires and Messerschmitt first... Camels and Fokkers later. He became a successful bass player with a career lasting over 35 years in several Rock bands, recording ten albums (one of them being a National hit selling more than 100,000 copies) and performing countless concerts, TV shows and tours all over Argentina.

Now retired from the R'n'R scene, his interest returned to his early passion: Aviation Artwork. Visiting the WW1 aircraft collection at Hendon focused his already growing interest for that historic period. His artwork is regularly appearing in journals and publications like Windsock Worldwide, Windsock Datafiles, Cross & Cockade and Over the Front.

Visit Ronny's Facebook page - www.facebook.com/RONNY-BAR-Aircraft-Profiles-166538664131/



Product Manager, Richard Alexander

A native of Wellington New Zealand, Richard Alexander has a long term interest in military history, race cars & local drivers from motor sports golden era of the '60's. An accomplished modeller Richard's models have twice been awarded Best Overall in Show at IPMS(NZ) National Conventions and earned him the inaugural TamiyaCon(NZ) Master Modeller award (along with the associated trip to Japan) in 2001. Many of his works are in private collections around the world, though he no longer accepts commissions.

Richard has been in the model and hobby industry since 1991 and brings with him a keen eye for detail and a passion for ensuring our models are enjoyable to build. So if there is anything you don't like about this model, you can blame him.

If you do have comments, requests or suggestions, Richard is contactable at richard@wingnutwings.com



Decal Art by Malcolm Laird

Malcolm has been in the scale model industry since 1981 and now produces his line of Ventura decals and a range of soft cover aviation books mainly with a Kiwi flavour. Outside work he suffers the dual afflictions of restoring old Kawasaki motorcycles and trying to paint impressionist landscapes, with 'mixed' results so far.

Visit Malcolm's web site at www.venturapublications.com.

Errata - Please check our website in case there are any corrections and updated information regarding this model.

- 30011 **C** Walter Kleffel, Jasta 18, January 1918 (1 victory). Updated painting and decal illustrations on our website.
- 30013 **E** Elevator is probably black **d** and not white as illustrated.
- 30014 **C** D.III engine.
- 30015 **A** Max Müller was reportedly shot down in Albatros D.Va 5405/17.
- 30016 **A** Not 5787/17. (serial number is still unconfirmed as at December 2018).
- 30017 **D** Updated colour scheme illustration on our website.

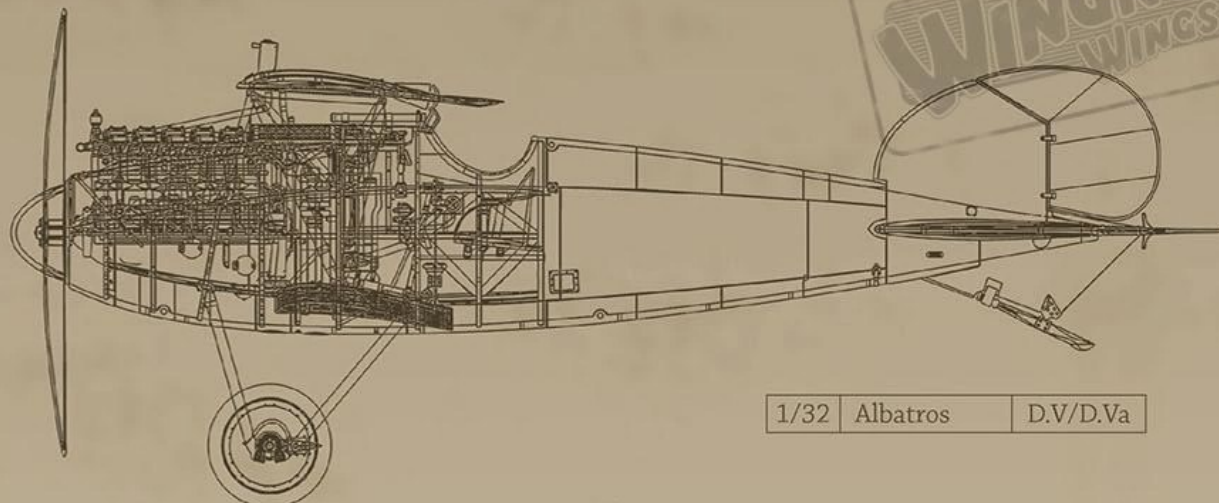
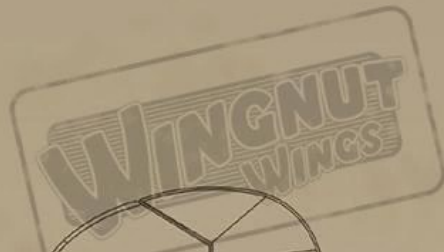

1/32 Albatros D.V/D.Va

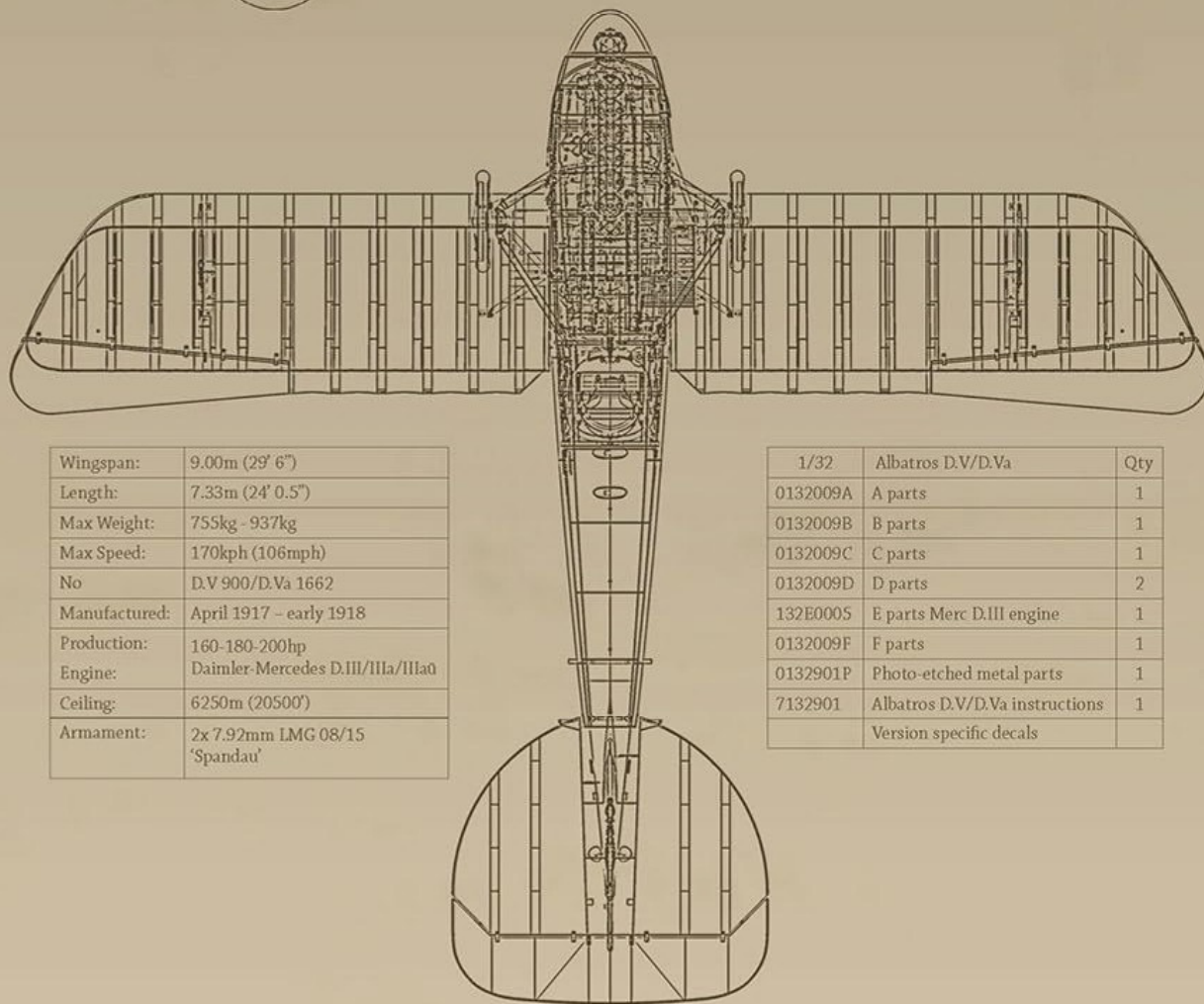

Wingspan:	9.00m (29' 6")
Length:	7.33m (24' 0.5")
Max Weight:	755kg - 937kg
Max Speed:	170kph (106mph)
No	D.V 900/D.Va 1662
Manufactured:	April 1917 - early 1918
Production:	160-180-200hp
Engine:	Daimler-Mercedes D.III/IIIa/IIIa0
Ceiling:	6250m (20500')
Armament:	2x 7.92mm LMG 08/15 'Spandau'

1/32	Albatros D.V/D.Va	Qty
0132009A	A parts	1
0132009B	B parts	1
0132009C	C parts	1
0132009D	D parts	2
132E0005	E parts Merc D.III engine	1
0132009F	F parts	1
0132901P	Photo-etched metal parts	1
7132901	Albatros D.V/D.Va instructions	1
	Version specific decals	

If you have any damaged or missing parts please contact help@wingnutwings.com for assistance.

www.wingnutwings.com

©2019 Wingnut Wings Ltd. PO Box 15-319 Miramar, Wellington 6022 New Zealand.

All rights reserved. Designed in New Zealand - Manufactured in China.

www.wingnutwings.com

30015

1/32

Albatros D.V

Flying Circus



A

Albatros D.V 1154/17,
Max Ritter von Müller,
Jasta 28,
late 1917.
(36 victories)

B

Albatros D.V 2329/17,
Otto Frühner,
Jasta 26,
mid 1917.
(27 victories)

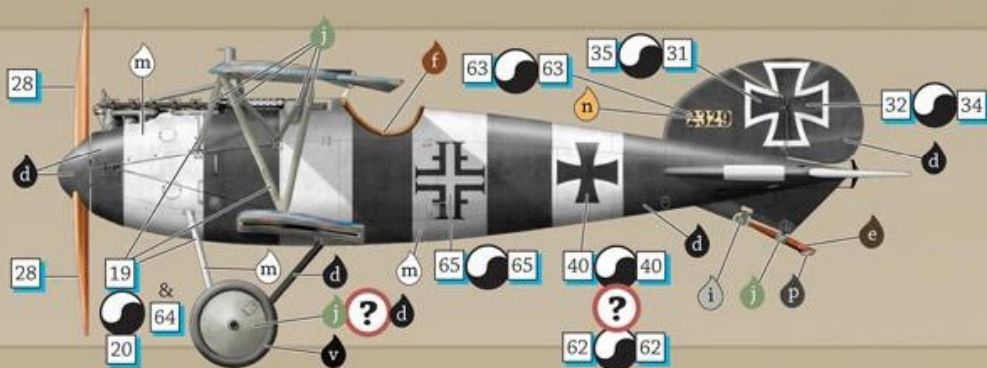

C

Albatros D.V 2359/17,
Otto Hohmuth,
Jasta 23b,
March 1918.
(4 victories)

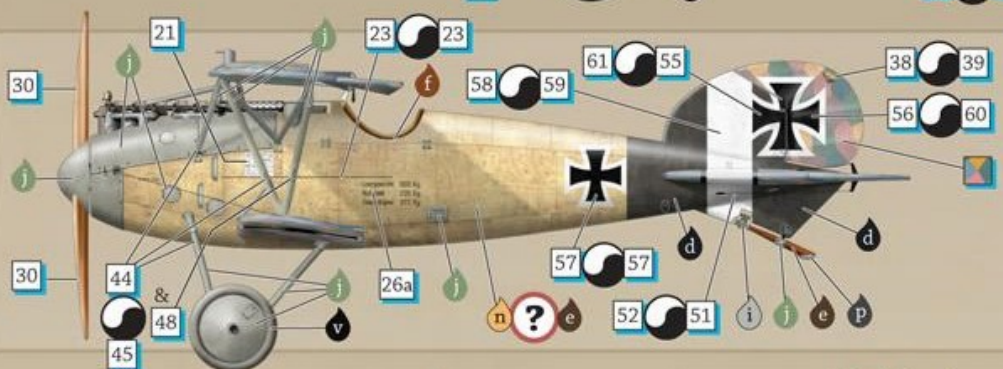

D

Albatros D.V,
Otto Könnecke,
Jasta 5,
July 1917.
(35 Victories)



E

Albatros D.V,
Karl Meierdirks,
Jasta 12,
July-August 1917. (2 victories)



A Albatros D.V 1154/17, Max Ritter von Müller, Jasta 28, late 1917 (36 victories)

Use optional parts C2 E1 F7 F8 and Daimler Mercedes D.III 160hp engine.



Bavarian born Max Müller joined the army before the war and transferred to aviation in 1913. After qualifying as a pilot in April 1914 he initially flew two-seaters and then Fokker Eindeckers. He would score his first 5 victories with Jasta 2 before transferring to the newly formed Jasta 28 in January 1917 where he scored 24 victories, including the Jasta's 1st on 7

April. He returned to Jasta 2 (now re-named 'Jasta Boelcke') in November 1917 and scored 7 more victories before jumping to his death from his flaming Albatros D.III (OAW) 5405/17 after combat with RE.8 B5045 and SE.5as of 60 Sqn on 9 January 1918. Max was 31. This photo, believed to have been taken in early August 1917, shows Albatros D.V 1154/17 in factory finish other than a red spinner, Max's 'comet' marking, Jasta 28 tailplane stripes and an unconfirmed dark colour under the rear of the fuselage which could be black (or red or...)? Max Muller reportedly had his aircraft painted differently every fortnight to confuse the enemy, future historians and modellers alike and this may have been one of the transitional steps to having the fuselage completely overpainted in a dark colour which is thought to have been red as we have illustrated.



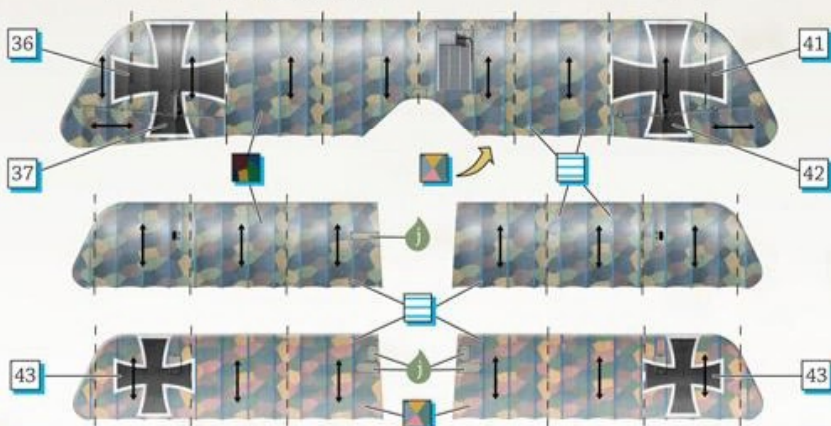

B Albatros D.V 2329/17, Otto Frühner, Jasta 26, mid 1917 (27 victories)

Use optional parts C1 E46 F6 F9 and Daimler Mercedes D.III 160hp engine.



Otto Frühner initially served as an aviation mechanic before becoming a pilot and flying two-seaters from May 1916. In July 1917 he transferred to Jasta 26 where he was awarded his 1st victory in September and had raised his score to 26 before he collided mid air with a 203 Sqn Sopwith Camel on 20 September 1918 which was

awarded as his 27th victory. He parachuted to safety but never returned to combat. Otto joined the Luftwaffe in 1935 and commanded various flying schools during the Second World War and rose to the rank of Major General. He died on 19 June 1965 aged 71. The wheels may have been  as illustrated or possibly , the black and white bands are Jasta 26 unit markings.

C Albatros D.V, 2359/17, Otto Hohmuth, Jasta 23b, March 1918 (4 victories)

Use optional parts C2 E1 E40 E44 F7 F8 and Daimler Mercedes D.IIIa 180hp engine.

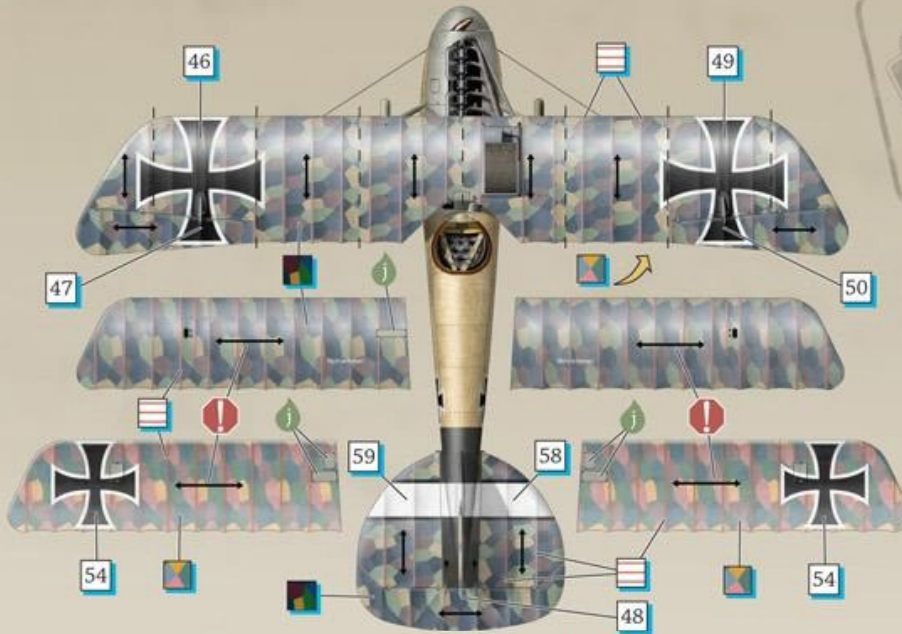

Otto Hohmuth served in the artillery before transferring to aviation in June 1916 and initially flew two-seaters with FAA267 where he scored 2 victories (shared with his observer). He transferred to Jasta 32b in July 1917 and then in September 1917 he went to Jasta 23b where he would score his final 2 victories. Otto was forced down and captured during combat with the 13 Sqn RE.8 of 2Lt F.Belway and Airman F.Rose on 6 March 1918. Seen here shortly after capture there are many unusual features visible on Hohmuth's Albatros including the lower wings being covered with 'spanwise' applied lozenge fabric and the style and size of all Eiserne Kreuz markings. The fuselage appears to have been stained or thinly painted with a darker colour but in some photos this is not apparent, the final decision is yours. An anemometer is fitted to the bottom of the right 'V' strut. This aircraft was eventually repainted in British markings and given the British serial number G144.



D Albatros D.V, Otto Könnecke, Jasta 5, July 1917 (35 Victories)

Use optional parts C3 E24 F7 F8 and Daimler Mercedes D.III 160hp engine.

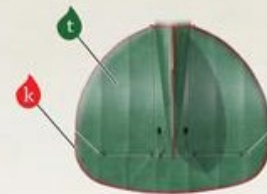

Otto Könnecke volunteered for service before the war, transferred to aviation in 1913 and was a flying instructor by the time war broke out. In December 1916 he joined Jasta 25 where he scored his first 3 victories. He was transferred to Jasta 5 in April 1917 where he would score his remaining 32 victories. Otto joined Lufthansa in 1926 and then the Luftwaffe in 1935 where he commanded various flying schools. He died on 25 January 1956 aged 63. Otto's Albatros seen here features his personal marking on the fuselage side and famous Jasta 5 nose and tailplane markings. All upper surfaces have been overpainted in a colour with a similar tone to the tailplane markings and this is thought to be the same Jasta 5 green but could be a camouflage green applied in a mottled finish. The upper wing appears very pale but this is thought to be caused by sunlight reflecting off the gloss doped fabric.



E Albatros D.V, Karl Meierdirks, Jasta 12, July-August 1917 (2 victories)

Use optional parts (C2) (E23) (E44) (F6) (F9) and Daimler Mercedes D.III 160hp engine.

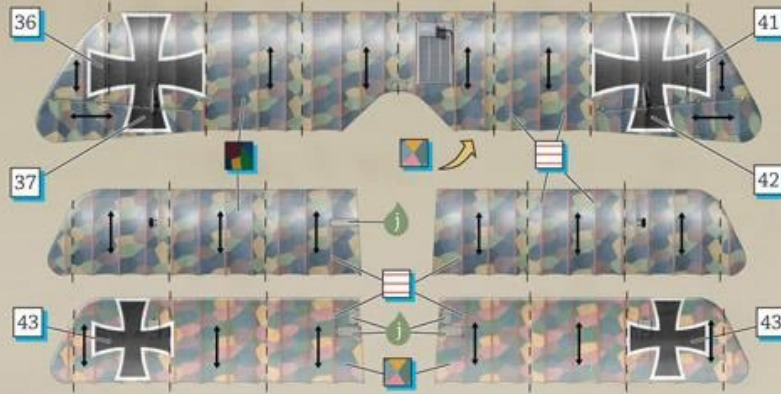

Karl Meierdirks served in Jasta 12 from 17 July 1917 until he transferred to Jasta 40 in August 1917 where he would score his 1st victory. He transferred to Jasta 55 in January 1918, where he scored his 2nd victory, and commanded it from April until he was shot down and killed on 4 May 1918. He was 21. Note the flare rack, tube protruding from below the cockpit behind the rear undercarriage leg and that the axle wing fairings have been removed. A black band around the nose cowlings with black rear fuselage and tailplane was the Jasta 12 unit marking.

All Colours	Tamiya	Humbrol	Misterkit
d Black - semi gloss	X18	85	
e Dark Wood - gloss	XF68	98	
f Leather - semi gloss	XF52	62	
g Light Blue - gloss	XF23(x1)+XF2(x1)	65	GC03
h Yellow - semi gloss	XF3(x10)+X6(x1)	24	GC14
i Light Grey - matt	XF19	64	GC08
j Interior Grey Green - matt	XF76	90	
k Red - gloss	X7	19	
m White - semi gloss	XF2	34	
n Light Wood - gloss	XF59	93	
o Mauve - gloss	X16(x1)+XF52(x2)	68(x1)+29(x2)	GC02
p Steel	XF56	27003	
q Clear Doped Linen	XF55	148	GC10
r Camouflage Green	XF65	116	GC05
t Jasta 5 Green - gloss	X5	24	
v Rubber - matt	XF69	66	
w Medium Grey Green - gloss	XF71	78	GC04
Decal 30001 5 Colour Upper Lozenge - available separately			
Decal 30002 5 Colour Lower Lozenge - available separately			
Decal 30005 German Rib Tapes for Lozenge - available separately			



If you require assistance please contact - help@wingnutwings.com

www.wingnutwings.com