

eduard
MASK

MiG-15

The die-cut mask for accurate canopy frame painting of the
Trumpeter 1/32 KIT

JX 019

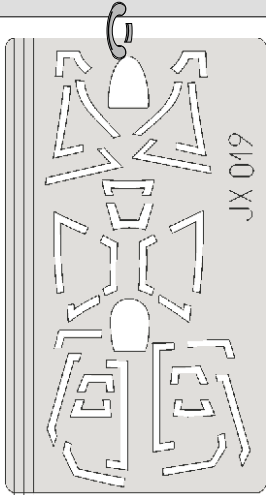

References:
4+ publication MiG-15 all variants

1.)

D1

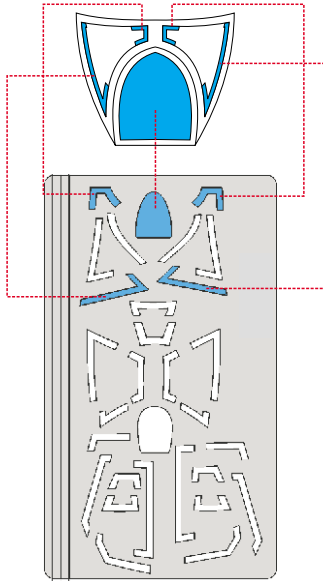

2.)

D1 LIQUID MASK

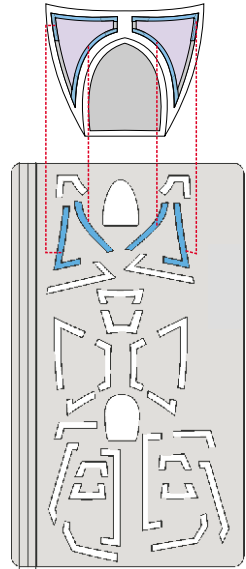

1.)

D4

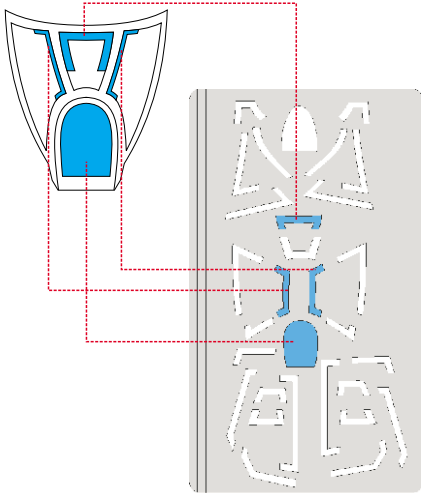

2.)

D4

LIQUID MASK

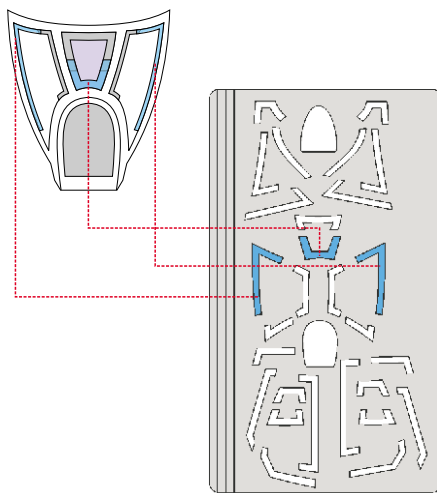

3.)

D4

LIQUID MASK

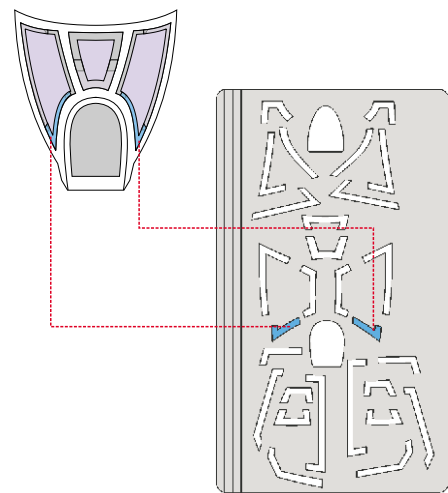

1.)

D2

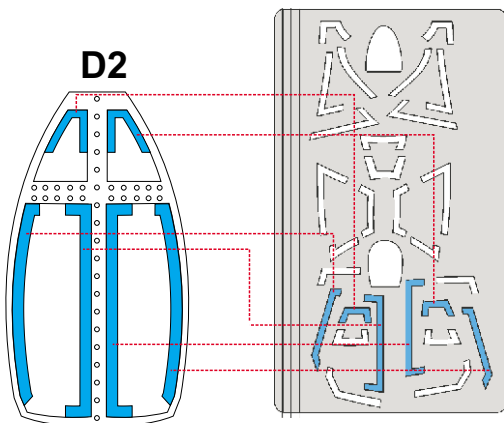

2.)

LIQUID MASK

D2

