

1/35 MILITARY MINIATURE VEHICLE UPGRADE SERIES PE35843







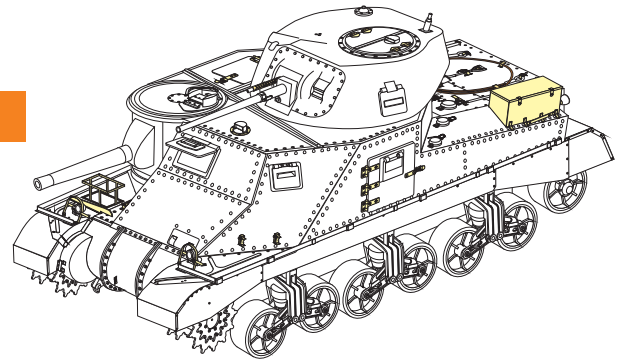
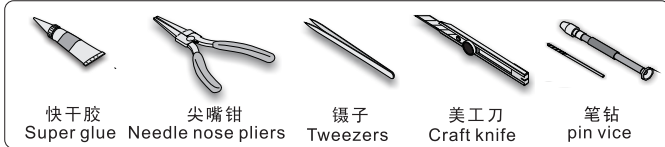

WWII British Grant Medium Tank basic

二战英国M3 格兰特 中型坦克基本改造件

[For TAKOM 2086]

推荐使用工具 RECOMMENDED TOOLS



- 
 安装
install
- 
 折叠
bend
- A1**
 改造件零件编号
PE/resin part number
- B12**
 原零件编号
kit part number
- C22**
 被替换的原零件编号
replaced kit part number
- 
 另一侧相同制作
repeat on opposite side
- 
 切除
remove
- 
 打磨
grind off
- 
 弧度卷曲
radial bending
- x2**
 制作若干组
multiple assembly
- 
 选择安装
alternative
- 
 钻孔
drill
- 
 用胶棒制作
make from plastic rod

 用尖端在凹槽处冲压
use penpoint to press on the dent

蚀刻片零件内朝面向上
Put the part upside down
 用笔尖在凹槽处刺
Use penpoint to press on the dent

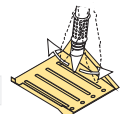
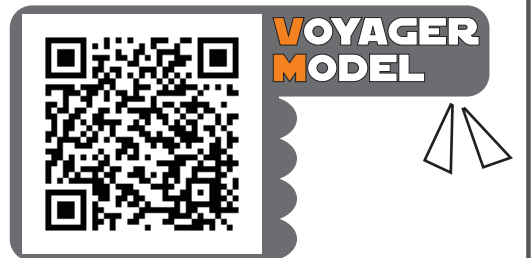
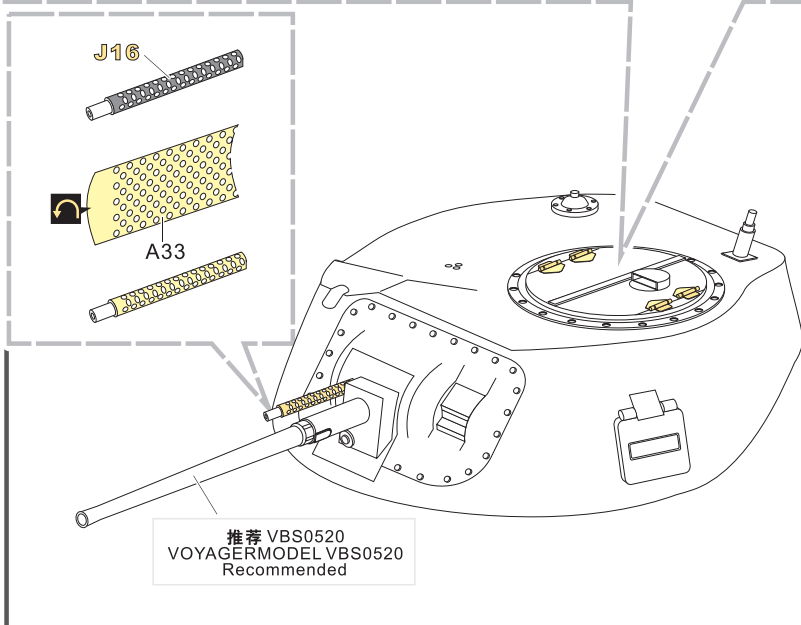
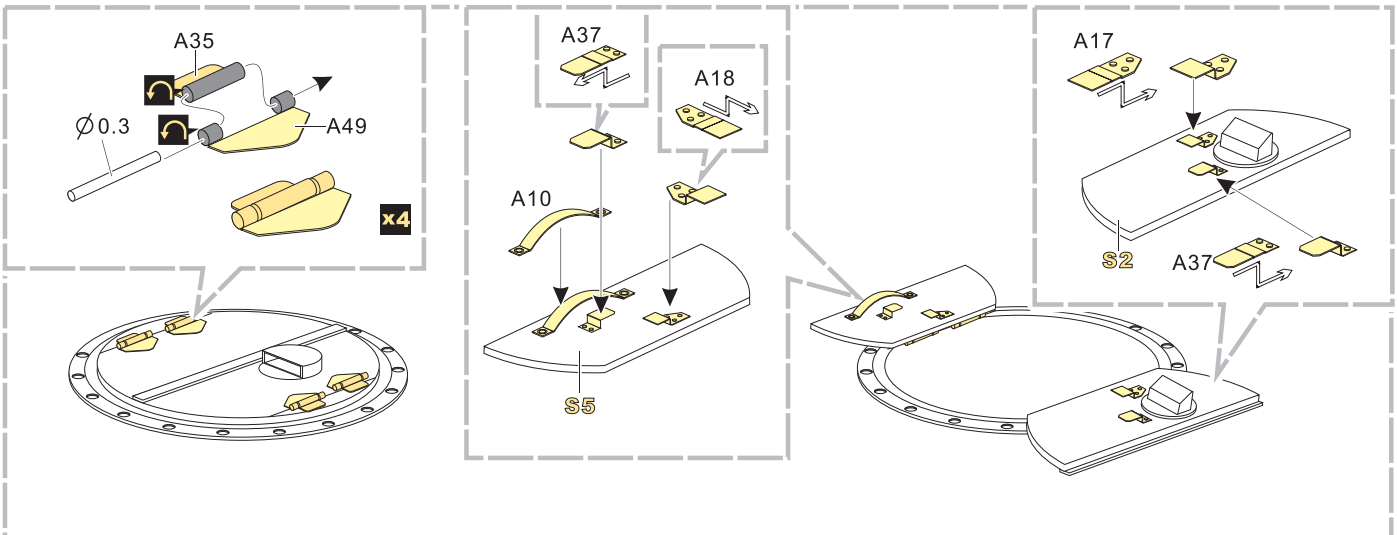
更多PE35843样品照片参考请扫一扫
 MORE PICTUER OF PE 35843
 REFERENCE SCAN HERE

VOYAGERMODEL [®] 无微不至 极尽享受 The Best Upgrade Solution	
Recommended item	
VBS0520	WWII US M3 Gun Barrel set
PEA 406	WWII British Grant Medium Tank Track Covers
PE 35842	WWII US M3 Lee tank
PE 35931	WWII US M31 tank recovery vehicle

1/35 MILITARY MINIATURE VEHICLE UPGRADE SERIES PE35843

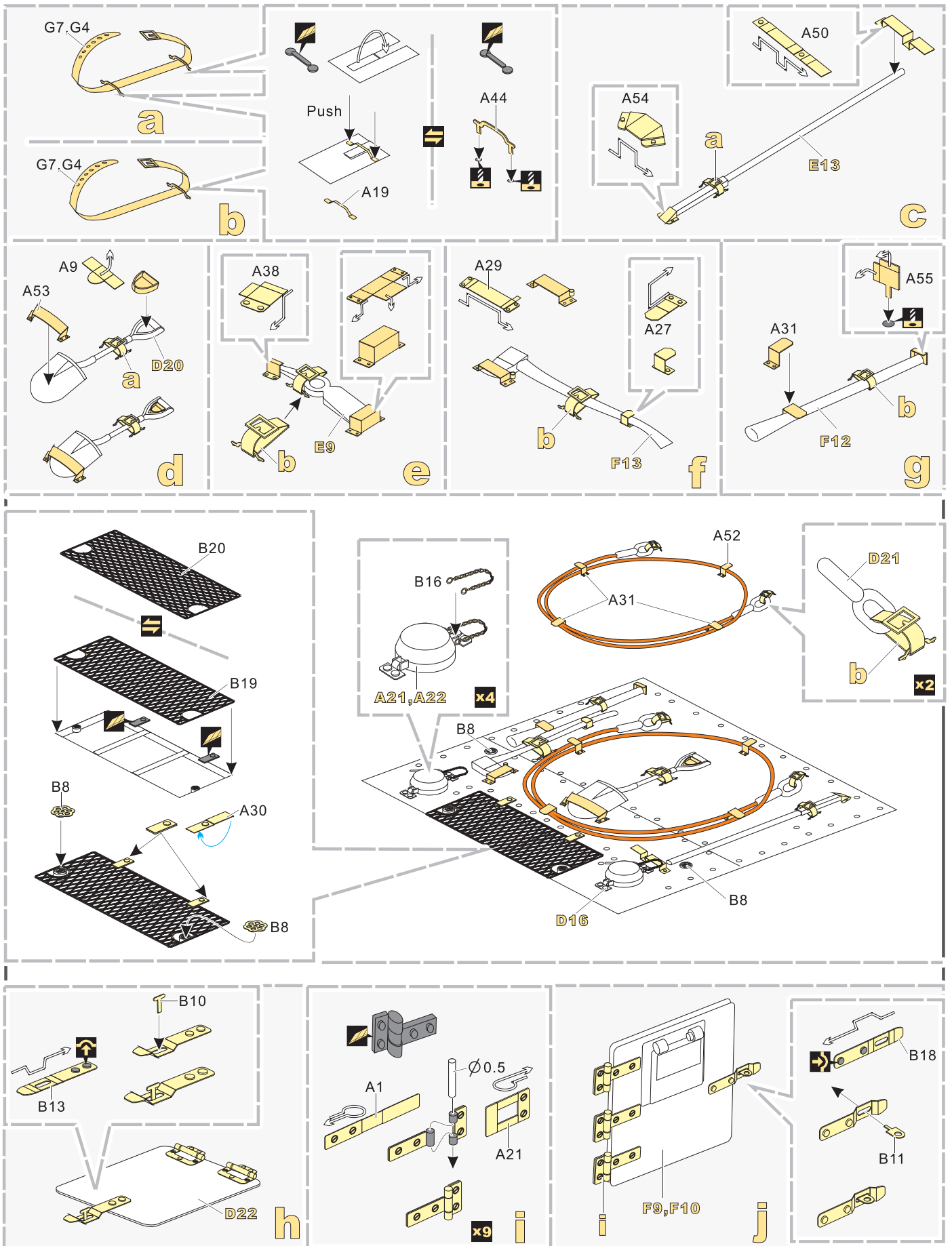

1/35 MILITARY MINIATURE VEHICLE UPGRADE SERIES PE35843

k

l

m

n

o

p

q

r

s

1/35 MILITARY MINIATURE VEHICLE UPGRADE SERIES PE35843

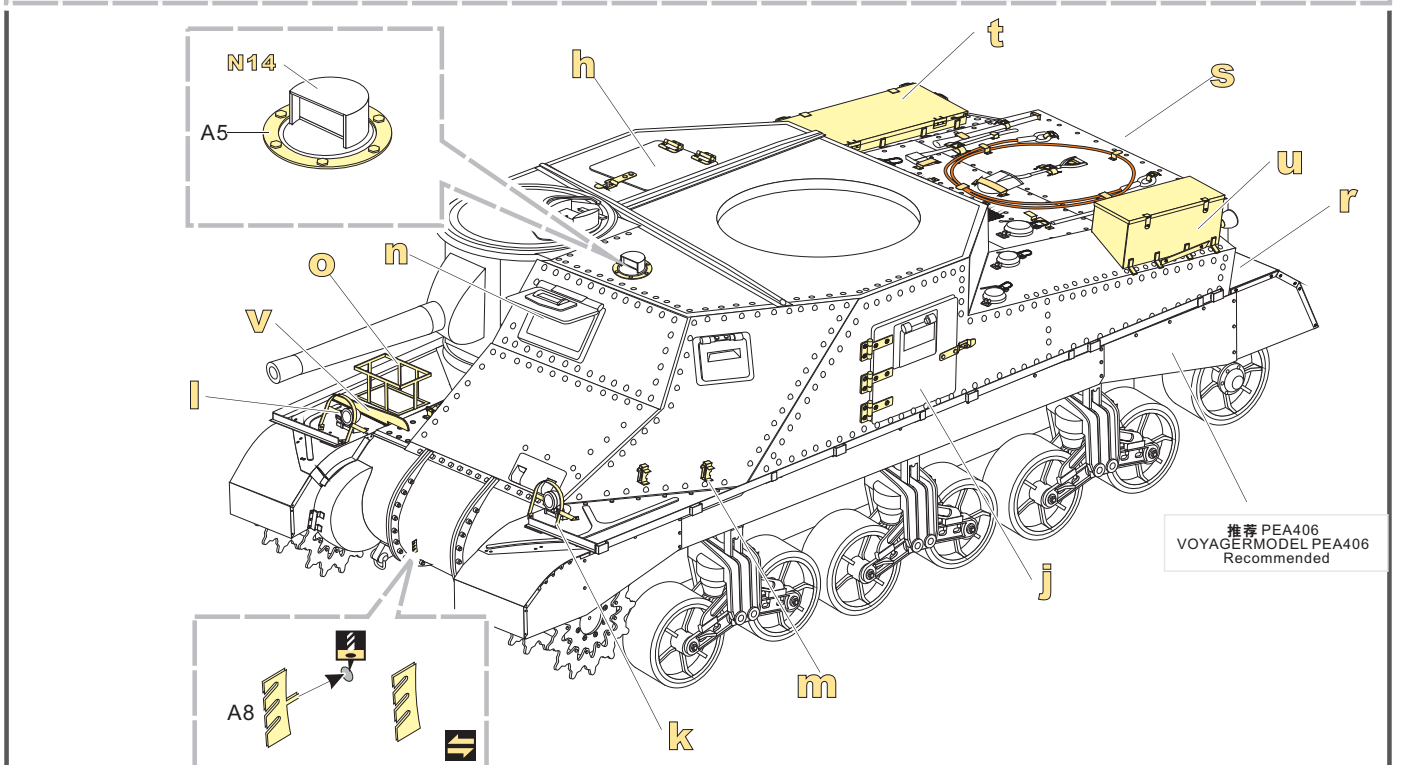
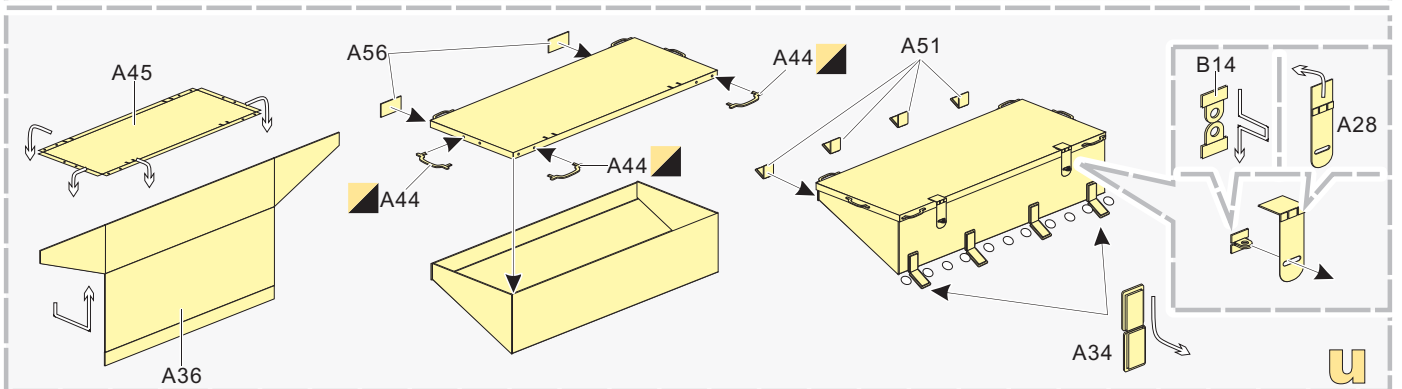
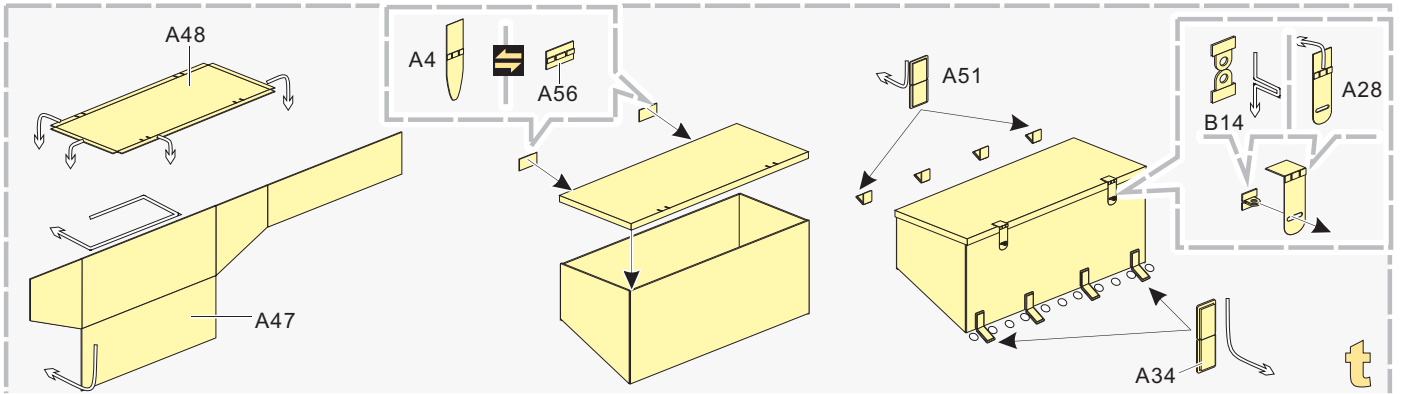

推荐 PEA406
VOYAGERMODEL PEA406
Recommended

