



Mosquito Mk.IV seatbelts FABRIC

eduard

32 839

1/32 scale detail set for kit HK Model • sada detailů pro model 1/32 HK Model

PE - PHOTOETCHED PART

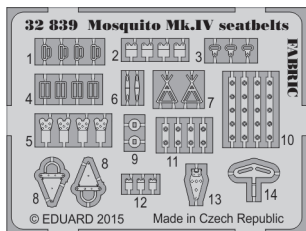

TP - TEXTILE PART

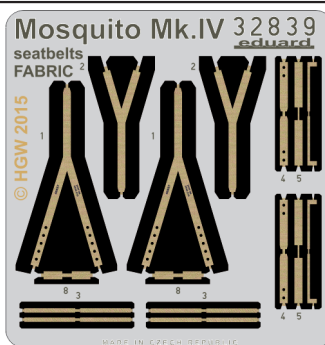

- ★ APPLY EXPRESS MASK AND PAINT BEFORE GLUING
POUŽIT EXPRESS MASK NABARVIT PŘED SLEPENÍM
- ☉ SYMMETRICAL ASSEMBLY
SYMETRICKÁ MONTÁŽ
- ☐ REMOVE
ODSTRANIT
- ☒ GRIND
OBROUSIT
- ☒ DRILL HOLE
VRTAT OTVOR
- 1 COLORED ETCHED PARTS
LEPTANÉ BAREVNÉ DÍLY
- ☑ BEND
OHNOUT
- ☐ ? OPTION
VOLBA
- ☒ REPLACE
NAHRADIT

ORIGINAL KIT PARTS
PŮVODNÍ DÍLY STAVEBNICE
 PHOTO-ETCHED PARTS
LEPTANÉ DÍLY
 PARTS TO BE REMOVED
DÍLY K ODSTRANĚNÍ
 FILL
TMELIT

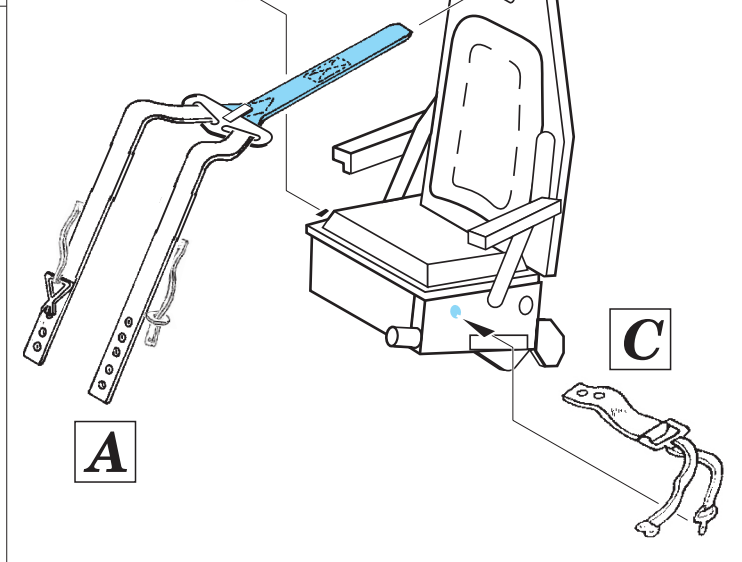
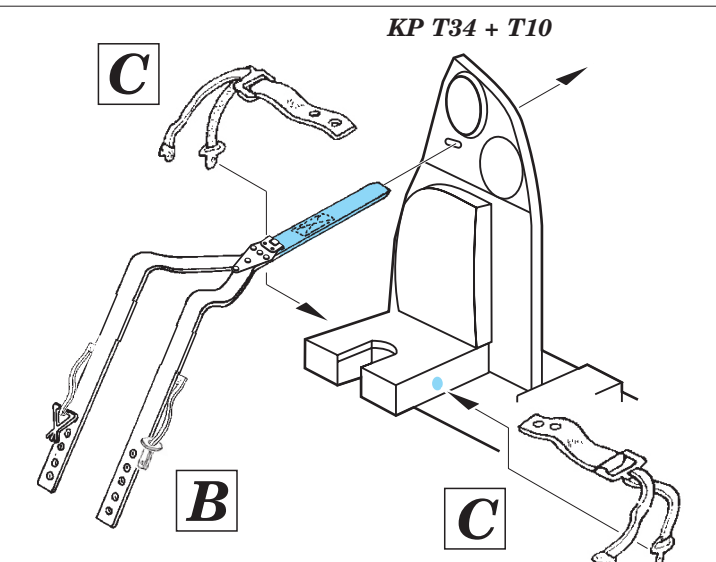
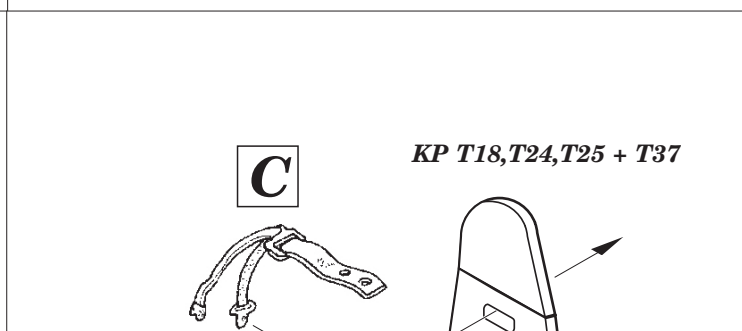
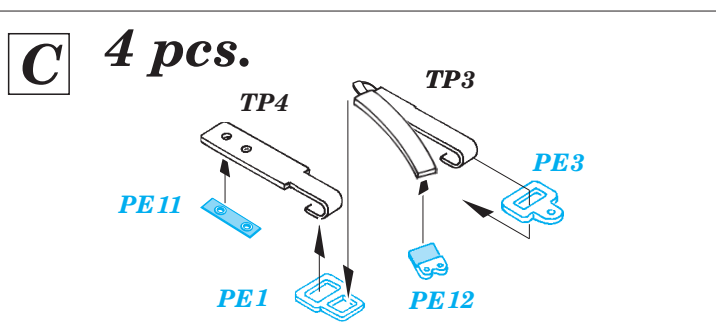
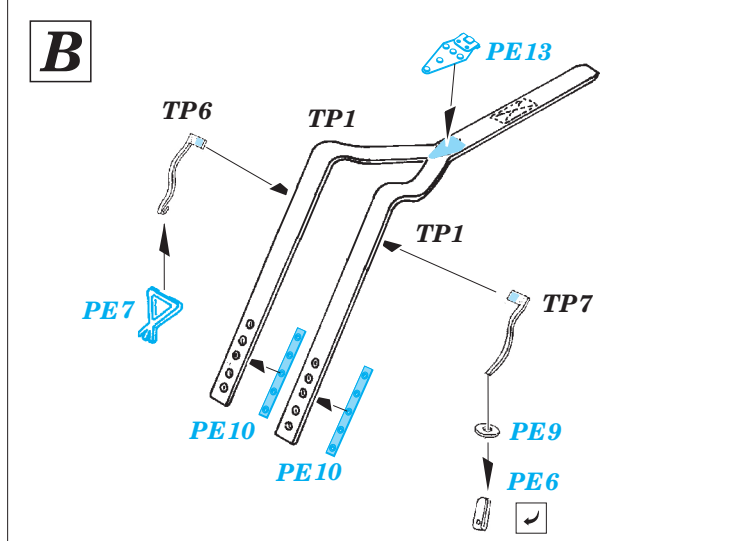
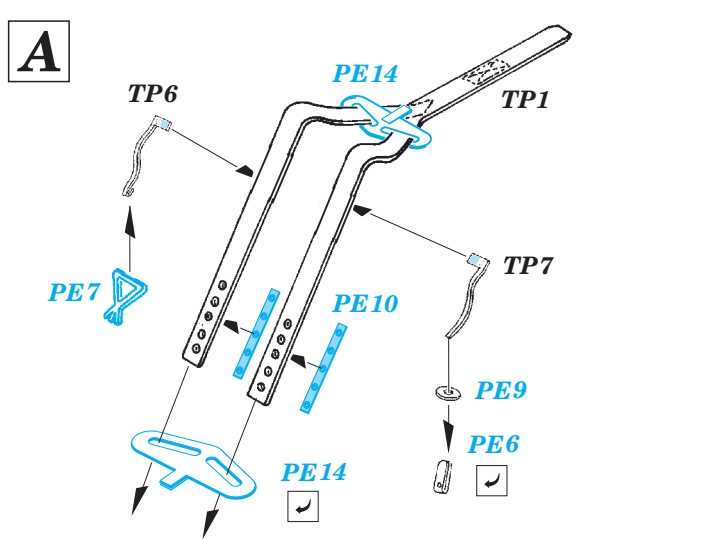

ENLARGE THE HOLE IN PLASTIC PART T34

ENLARGE THE HOLE IN PLASTIC PART T18