

48th Scale

NO.

48-21

B-17's #2



MICROSCALE DECAL

BY KRASEL INDUSTRIES, INC. SANTA ANA, CA 92705

AIRCRAFT

Recommended model: Monogram B-17G.

Additional mission markers are provided for use as desired.

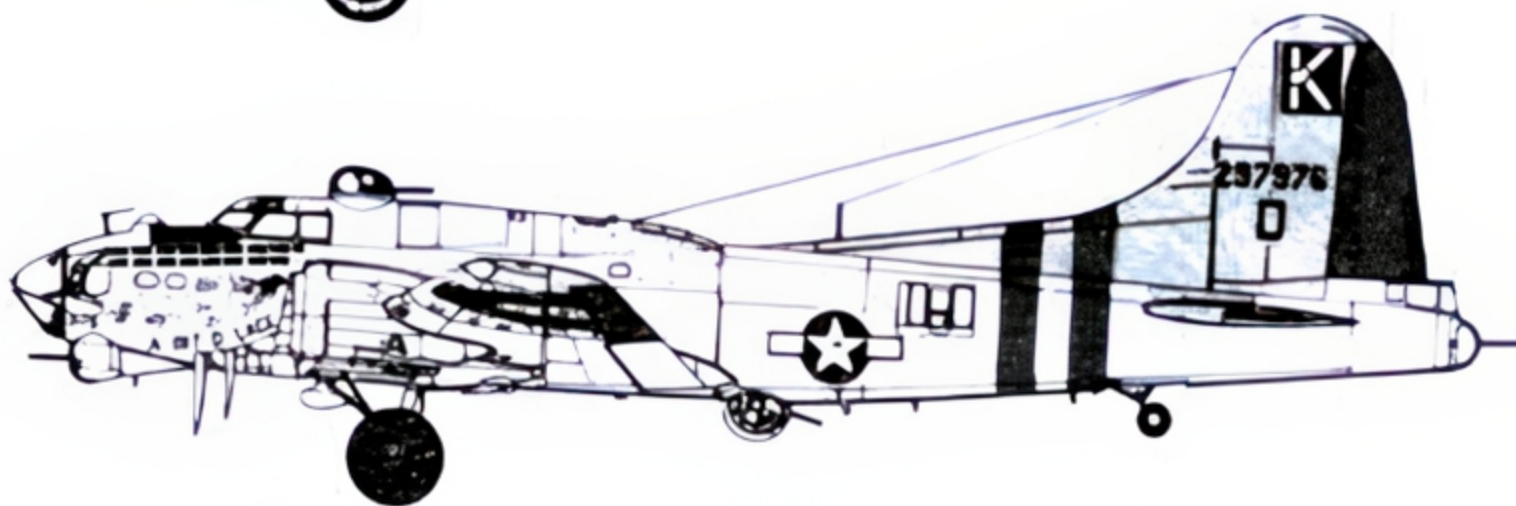
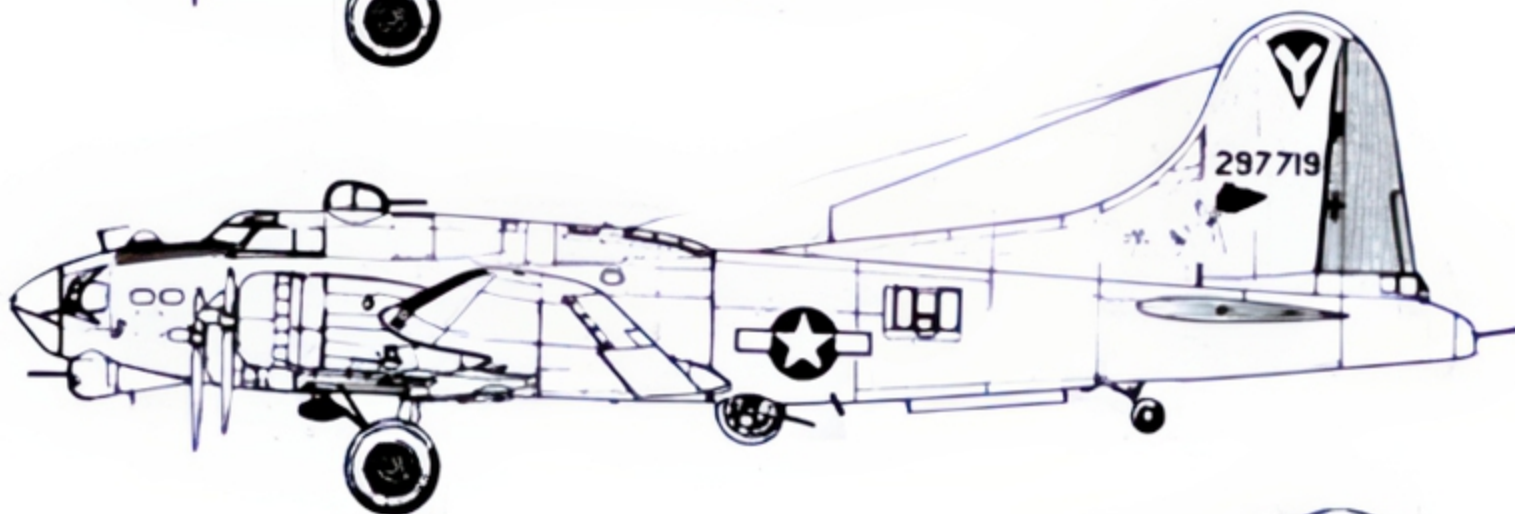

U.S. National insignia can be obtained from MICROSCALE sheet #48-23.

|            |          |           |          |
|------------|----------|-----------|----------|
| Olive Drab | FS34087  | Green     | FS 14110 |
| Gray       | FS 16473 | Dk. Blue  | FS 15044 |
| Yellow     | FS 13538 | Zinc Chr. | FS 33434 |
| Red        | FS 11105 |           |          |

For a realistic natural-metal finish, use MICROSCALE METAL FOIL ADHESIVE with household aluminum foil. Follow the simple directions provided with the adhesive for a beautiful, authentic metal finish. Available at your hobby dealer's.



The International Plastic Modelers Society is an organization devoted to developing the plastic modeling art. It was formed "By Modelers - For Modelers". If you wish to expand your modeling talents, write for further information to: IPMS/USA, New Member Information, P.O. Box 2555, Long Beach, Ca., 90801; or P.O. Box 163, Ben Franklin Station Washington D.C., 20044.

for use as desired.

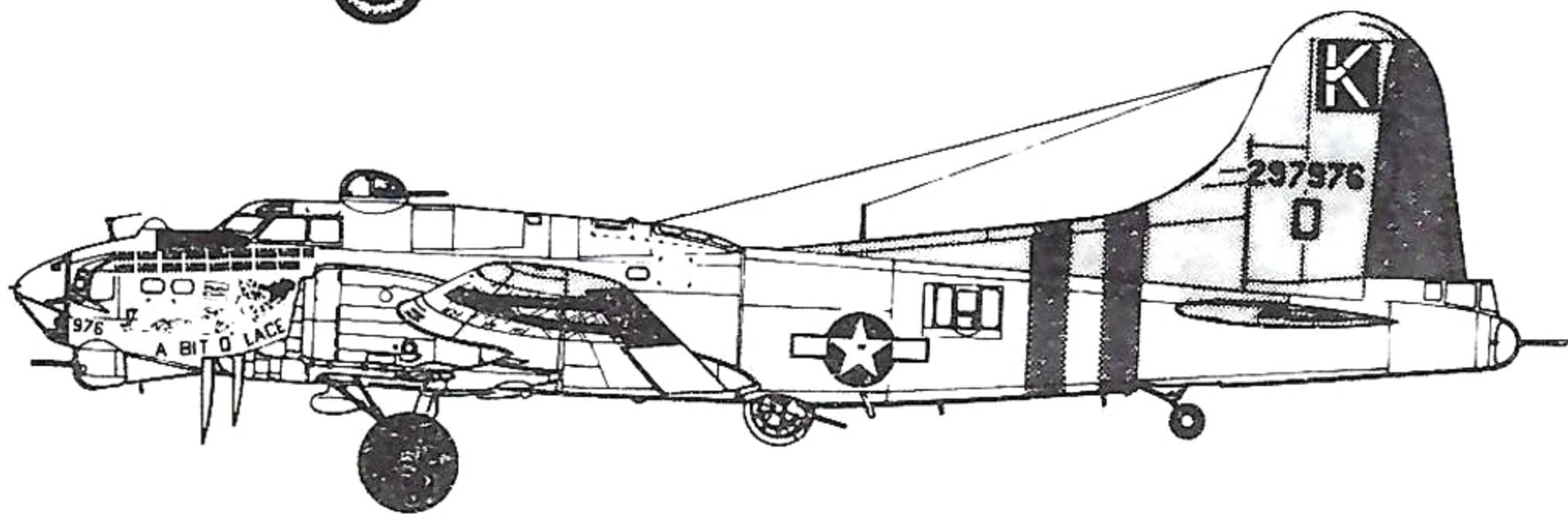
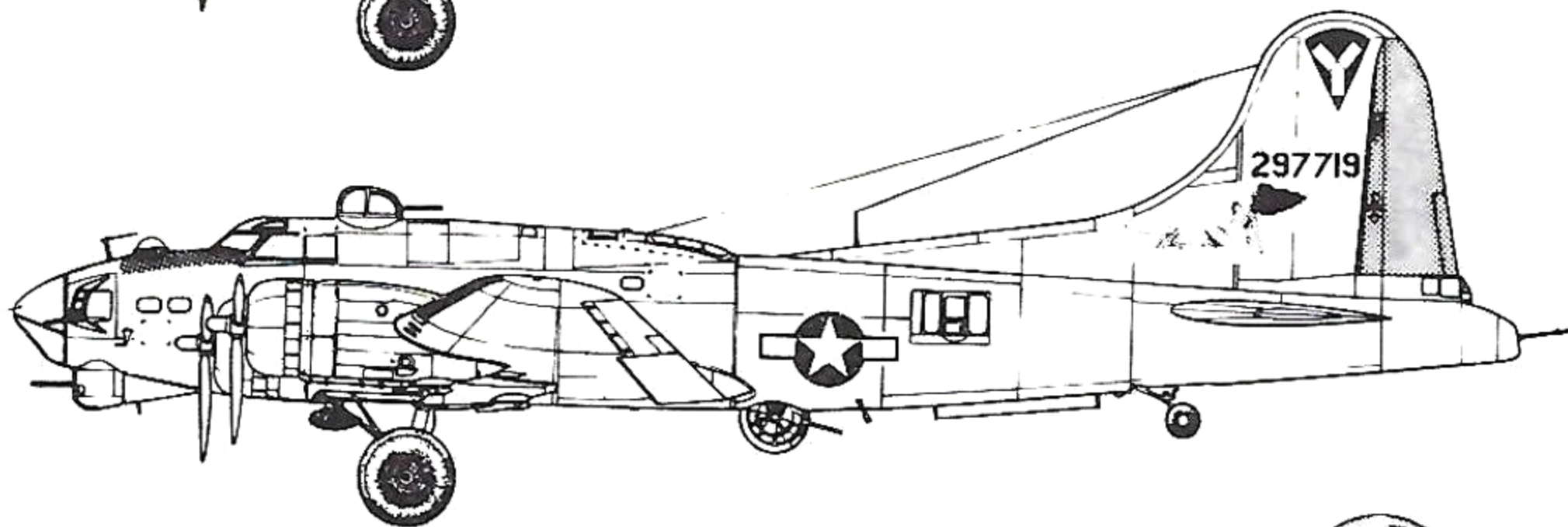
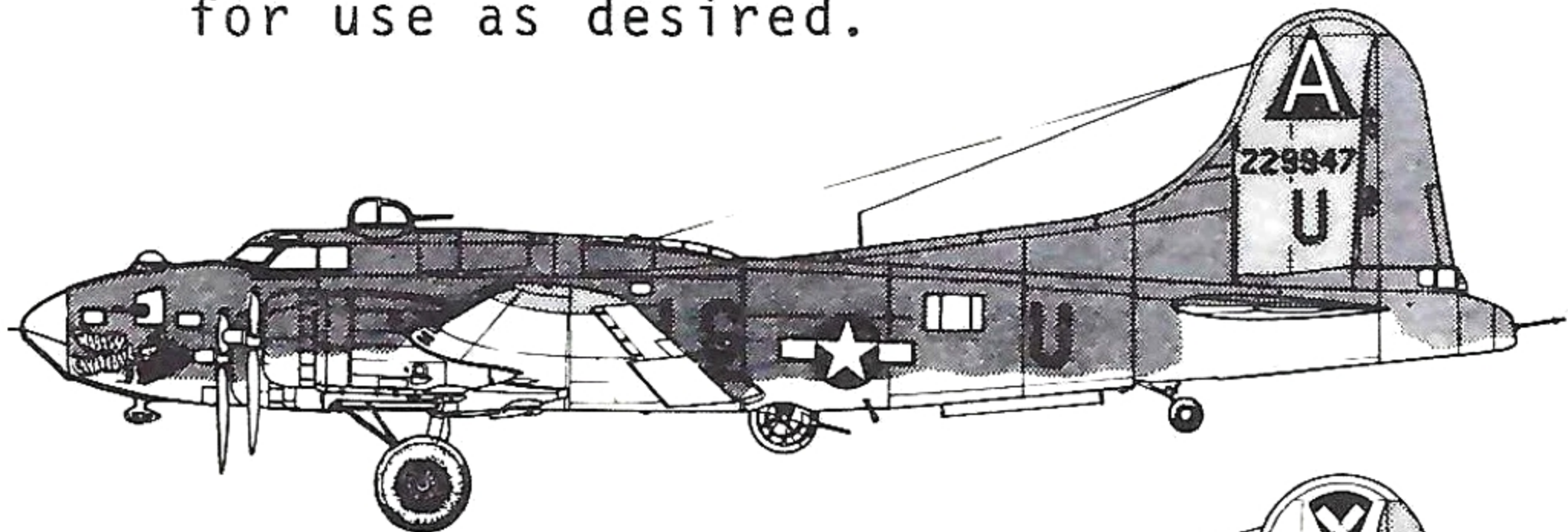

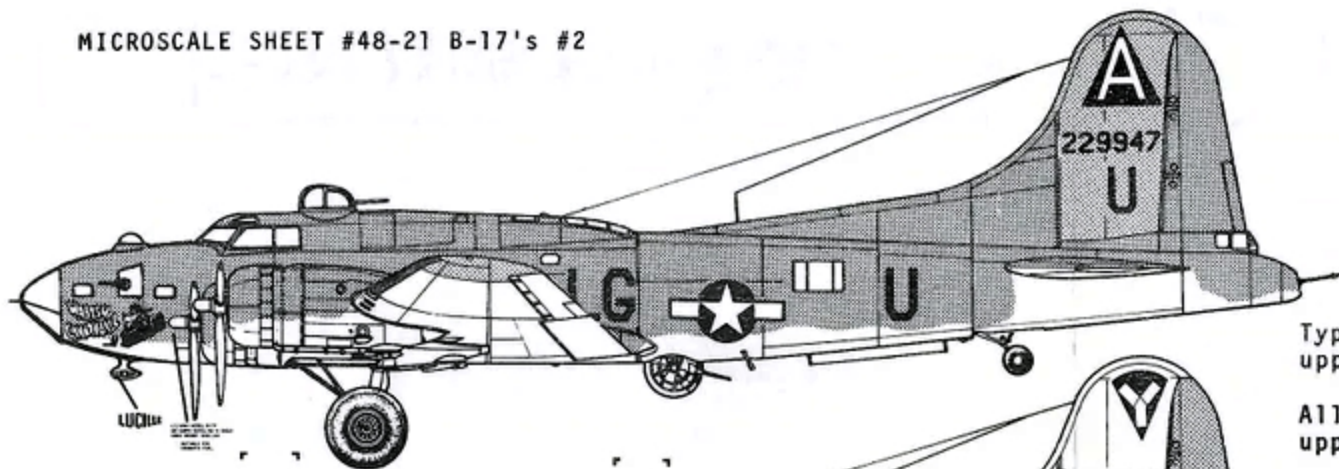

**B-17F WABASH CANNONBALL**  
322 BS, 91st BG

Delete chin turret, add large gun window to each side of nose, move radio loop under nose. Olive drab top, gray bottom. Red fin, stabilizer and wing tips, top and bottom. Elevators and rudder remain camouflaged.

Typical placement of wing code letter, upper right wing only.

All aircraft have National insignia on upper left and lower right wings.

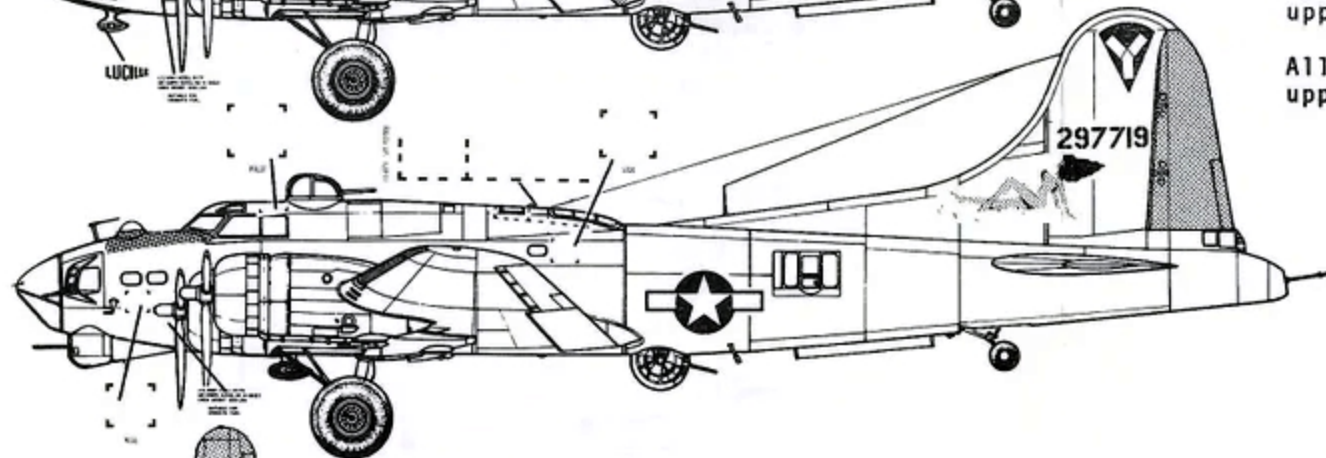

**B-17G 463rd BG, 5th BW**

Overall bare metal. Yellow rudder. Olive drab antiglare panels. Emergency exit markings typical of bare metal B-17's.

**B-17G A BIT O' LACE, 447th BG, 8th AF, 4th BW**

Basically bare metal except for left outer wing panel which was a replacement from a camouflaged B-17. The olive drab and gray still showed in rough patches. The left aileron and all tail controls were camouflaged. Fin and stabilizers were yellow on both sides, as were the wingtips. Fuselage stripes were green. Wing chevrons were dark blue and appeared on upper right and lower left wings. Nose antiglare panel was flat zinc chromate, very yellow. Engine antiglare panels were olive drab and applied to upper inboard quarter of each nacelle. Engine cowlings were white but had yellowed to about FS23717. A Cheyenne tail turret was fitted late in the war.

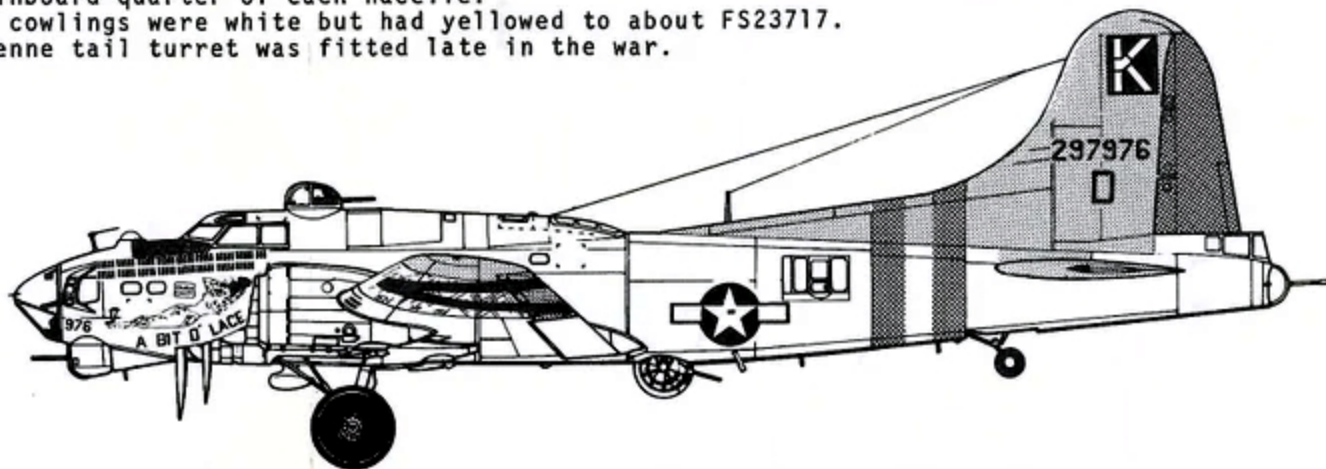
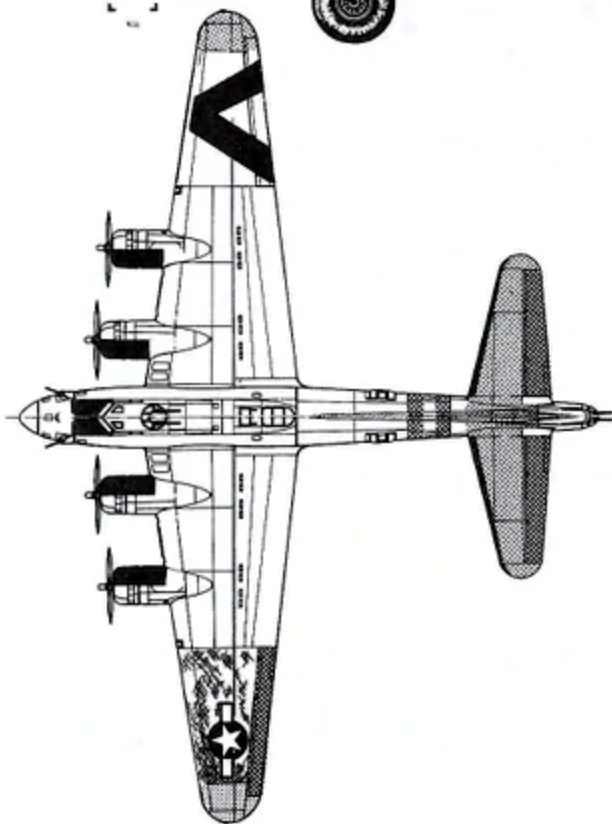

48th Scale  
48-21



B-17's #2  
**MICROSCALE DECAL**  
BY KRASEL INDUSTRIES, INC., SANTA ANA, CA. 92705

AIRCRAFT

The MICRO SCALE DECAL is the thinnest, most versatile decal made. It will conform to the irregular surfaces found on models because of its strength and flexibility. These characteristics are not found on any other decal made. When used with the MICRO SCALE SYSTEM the MICRO SCALE DECAL will help produce the most realistic model you can make.

The MICRO SCALE SYSTEM is simple to use but each step must be followed as described to assure perfect results. The elimination of any step may cause blushing (silvering of the decal film) or an uneven finish on the completed model.

#### The MICRO SCALE DECAL SYSTEM

1. Surface to be decalced must have a smooth, glossy, painted finish. (Do not apply decals to unpainted surfaces or they will not adhere.) To obtain this surface either paint the model with glossy paints or spray MICRO GLOSS over matte-finish paint. **IMPORTANT:** Spray MICRO GLOSS over entire model or uneven patches will appear when the flat finish is added later. Allow paint to dry thoroughly.
2. For best results, surface to be decalced should be horizontal. A small vise is helpful here, or a box can be made into a jig to allow the model to lay on its side.
3. Cut each decal subject from the sheet only as needed. **DO NOT** cut clear film away from design. Using tweezers, dip decal completely into water then remove and allow decal adhesive to soften. About one minute should be sufficient.
4. While adhesive is softening use a soft, medium-size brush, a No. 7 red sable water color brush is ideal, and wet the area to be decalced with a few drops of MICRO SET (Blue label). This contains a wetting agent and helps eliminate tiny air bubbles.
5. Holding the decal paper with tweezers, use the brush to slide the loosened decal into the MICRO SET on the model.
6. Now place a few drops of MICRO SOL (Red label) directly onto the decal and position the decal exactly where it is to remain.
7. The MICRO SOL will soften the decal and allow it to conform exactly to the surface beneath. **DURING THIS PROCESS THE DECAL WILL WRINKLE AND DISTORT. DO NOT TOUCH IT! THIS IS NATURAL AND AN IMPORTANT PART OF THE SYSTEM!** As the decal dries it will flatten-out and lay down. When finally dry there will be no distortion and the decal will be permanently bonded to the paint beneath. Actual drying time will vary according to temperature and humidity.
8. When decal is dry, examine it for any air bubbles. If any are found, puncture them with a sharp needle and put a drop of MICRO SOL over the bubble and allow to dry.
9. Carefully examine the clear film to be sure no silvering has appeared. If any is present, puncture the film several times with a sharp needle and apply MICRO SOL. The silvering should vanish as the SOL touches it.
10. After the decals have dried for several hours, carefully wash the decal adhesive from the entire model.
11. After the decals have dried for at least 12 hours, complete the model by spraying with either MICRO FLAT or MICRO GLOSS, depending on the sheen desired on the finished model.

### FULL SIZE TEMPLATE FOR 1/48 SCALE CHEYENNE TAIL TURRET.

