

eduard
Express Mask

XS 535

F4F National Insignia red outline

FOR 1/72 KIT

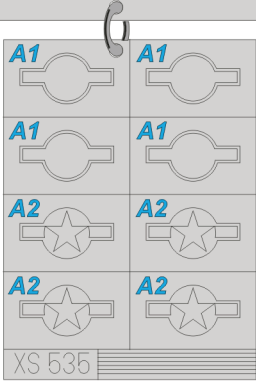

1.)

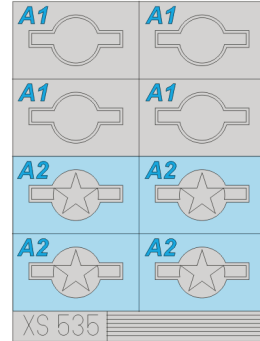
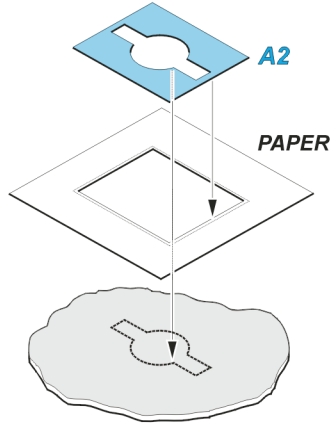

REFERENCES:

IN DETAIL & SCALE VOL.65
John M. Elliott
THE OFFICIAL MONOGRAM
US NAVY & MARINE CORPS
AIRCRAFT COLOR GUIDE
(vol.2 1940-1949)

2.)

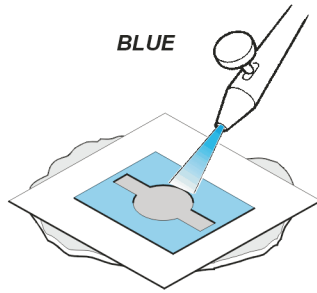

3.)

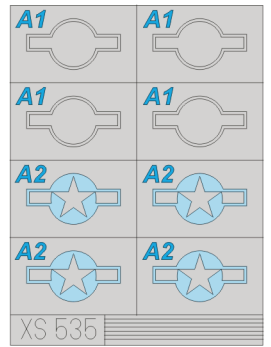
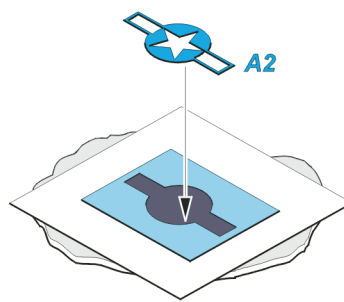

4.)

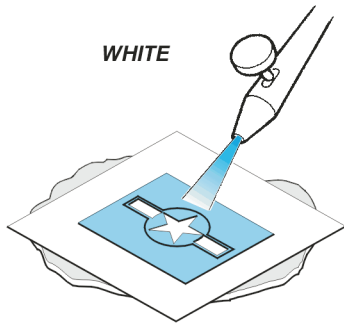

5.)

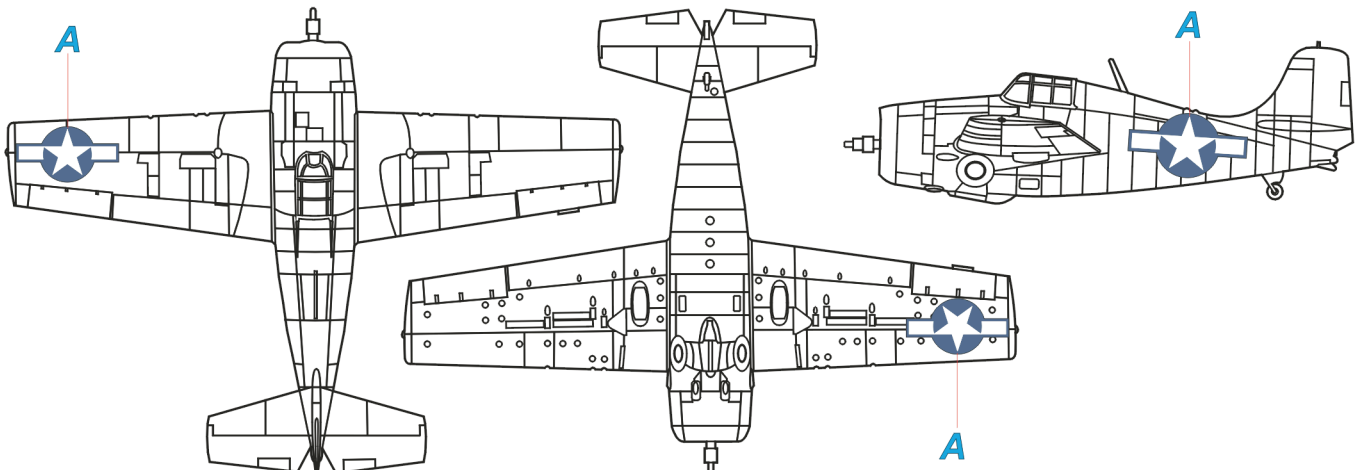
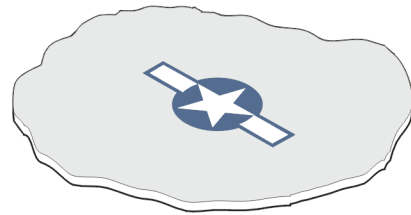

1.)

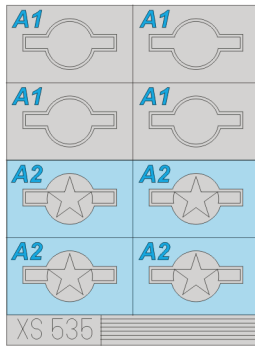
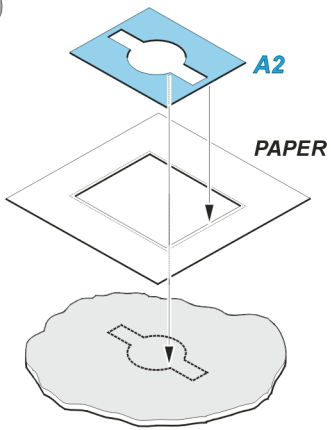

2.)

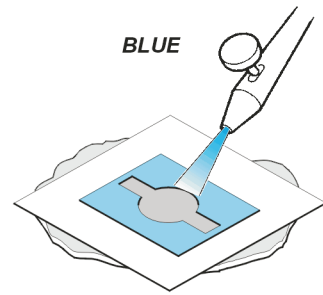

3.)

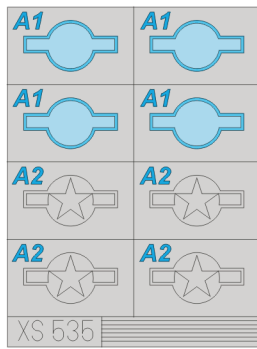
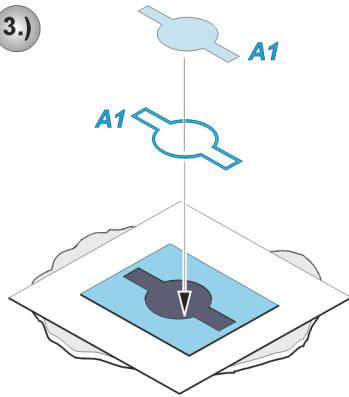

4.)

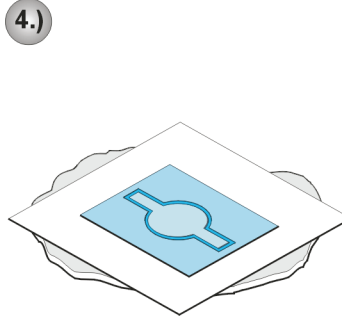

5.)

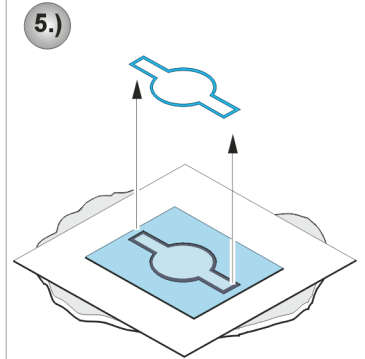

6.)

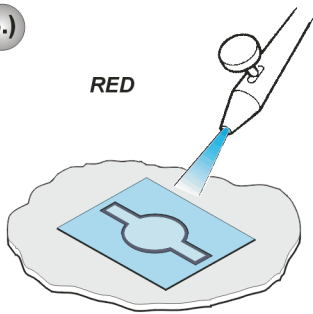

7.)

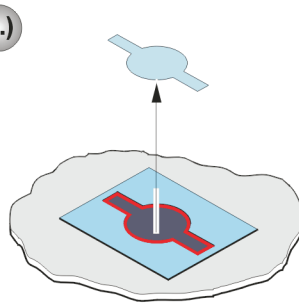

8.)

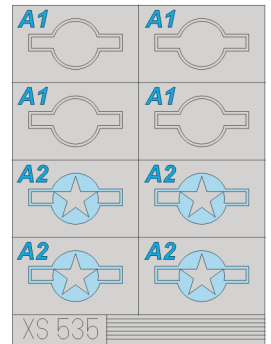
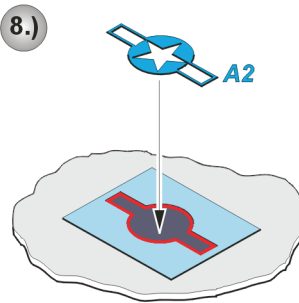

9.)

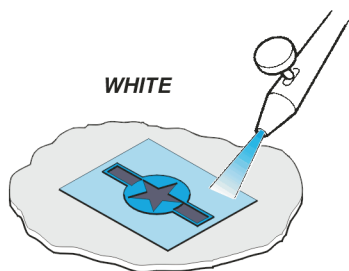

10.)

