



Modeller's Handbook · 取扱説明書 · 模型製作手冊

Kanonenjagdpanzer/Beobachter



Vor dem Zusammenbau lesen!

DW35031

Attention · 取り扱い上のご注意 · 注意事項

1. Please read this manual through carefully before assembling and keep it for future reference.
2. WARNING: Kit contains small and sharp parts. Children under 14 years old should be supervised to ensure that they do not play with any parts.
3. WARNING: Keep plastic bags away from babies and small children to avoid the danger of suffocation.
4. Be sure to ventilate the work area and keep away from fire or flammable gas when using cement or paint.
5. It is highly recommended to do pre-assembling or dry-fitting before gluing. Test to ensure that the pieces will fit together properly or neatly.
6. Beware of personal injury that may be caused by sharp tools (such as Design Knife) & ensure that fingers are free from the path of the blade.

Assembly Guide Icons · 組み立て指示記号について · 組立指示符號

Apply cement 接着 塗部水粘接	Do not cement 接着しません 不用膠水粘接	Super glue (For metal) 瞬間接着劑 (金屬用) 快幹強力膠 (金屬用)	Optional どちらかを選択 可選擇製作	Make 2 pcs 2セット作成 製作2組	Be careful 慎重に! 謹慎留意
Remove 切り落とす 去掉、切除	Cut off ナイフで切断 用刃切断	Drill hole 穴を開ける 鑽孔	Fill hole 穴を埋める 填孔	Fold 折り曲げる 折疊	Press 力を加える 用手指按壓
Apply decal デカール貼り 貼水印紙	Color guide 塗装色指示 模型油塗色	Allow glue to dry for several minutes 完全に乾くまで時間をおく。 請等待數分鐘直至膠水幹固。			

		COLOR	RAL	Tamiya	Mr Hobby H-Series	AMMO of MIG	Vallejo	Humbrol	Mission Models
A	Bronzegrün	6031	XF67	H080	0084	71.093	150	MMP-034	
B	Teerschwarz	9021	XF69	H401	0046	71.251	032	MMP-035	
C	Lederbraun	8027	XF68	H017	0085	71.249	098	MMP-033	
D	Gelboliv	6014	XF51	H052	0087	71.013	155	MMP-024	
E	Signalbraun	8002	XF79	H037	0079	71.034	062	MMP-141	
F	Red	3020	XF7	H003	0049	71.058	153	MMP-101	
G	Wood		XF94	H043	0036	71.077	110	MMP-123	
H	Steel		XF56	H018	0191	71.065	5025	MMM-002	
I	Black	9005	XF1	H012	0046	71.057	033	MMP-047	
J	Transparent Red		X27	H090	0093	70.934	1321	MMP-167	
K	Transparent Orange		X26	H092	0097	70.935	1322	MMP-171	
L	Rubber		XF85	H077	0033	71.315	032	MMP-040	
M	Silver	7001	X11	H008	0195	71.063	011	MMM-006	
N	White	9003	XF2	H011	0050	71.001	034	MMP-001	
O	Sandgelb	1002	XF59	H027	0061	71.074	093	MMP-039	
P	Khaki		XF49	H081	0113	71.330	159	MMP-023	

Parts List · パーツリスト · 部品清單

Please check all the following items. If anything is missing or damaged, contact your dealer immediately.
 下記のパーツ類が全部揃っているか確認してください。万一製品に破損や欠品がございましたら、すぐにご購入元までご連絡ください。
 請檢查包裝盒內的下列部件，如有漏失或損壞，請立即聯繫您的銷售商。

Kajapa
90mm 坦克殲擊車

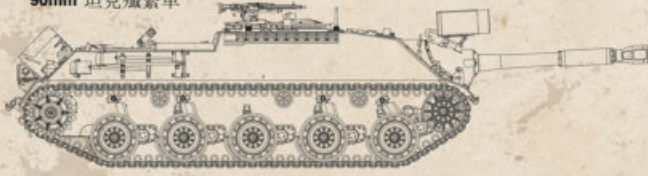

BeobPz
砲兵観測車

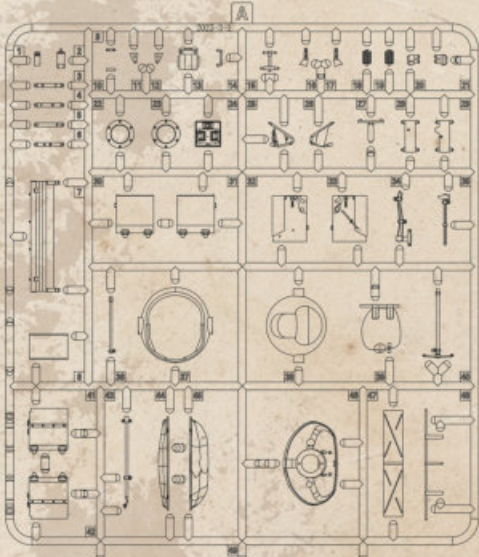
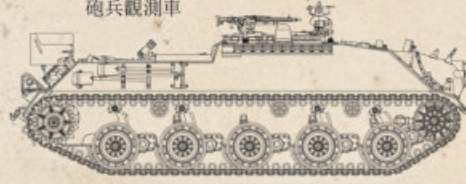

A:1pc

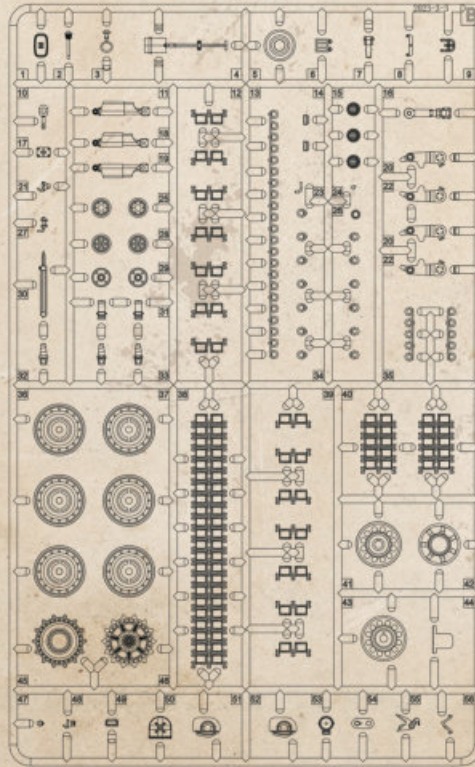

B:4pcs

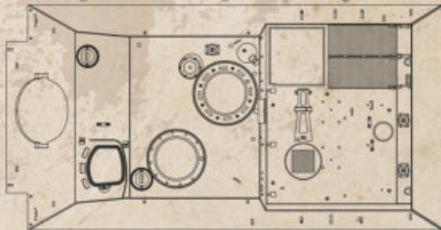

C:1pc



Decal:1pc

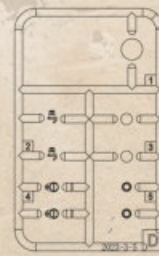

D:1pc



Z:1pc

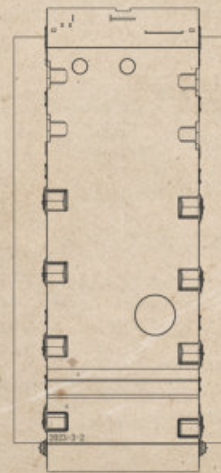

Lower Hull:1pc

Tow Cable

1

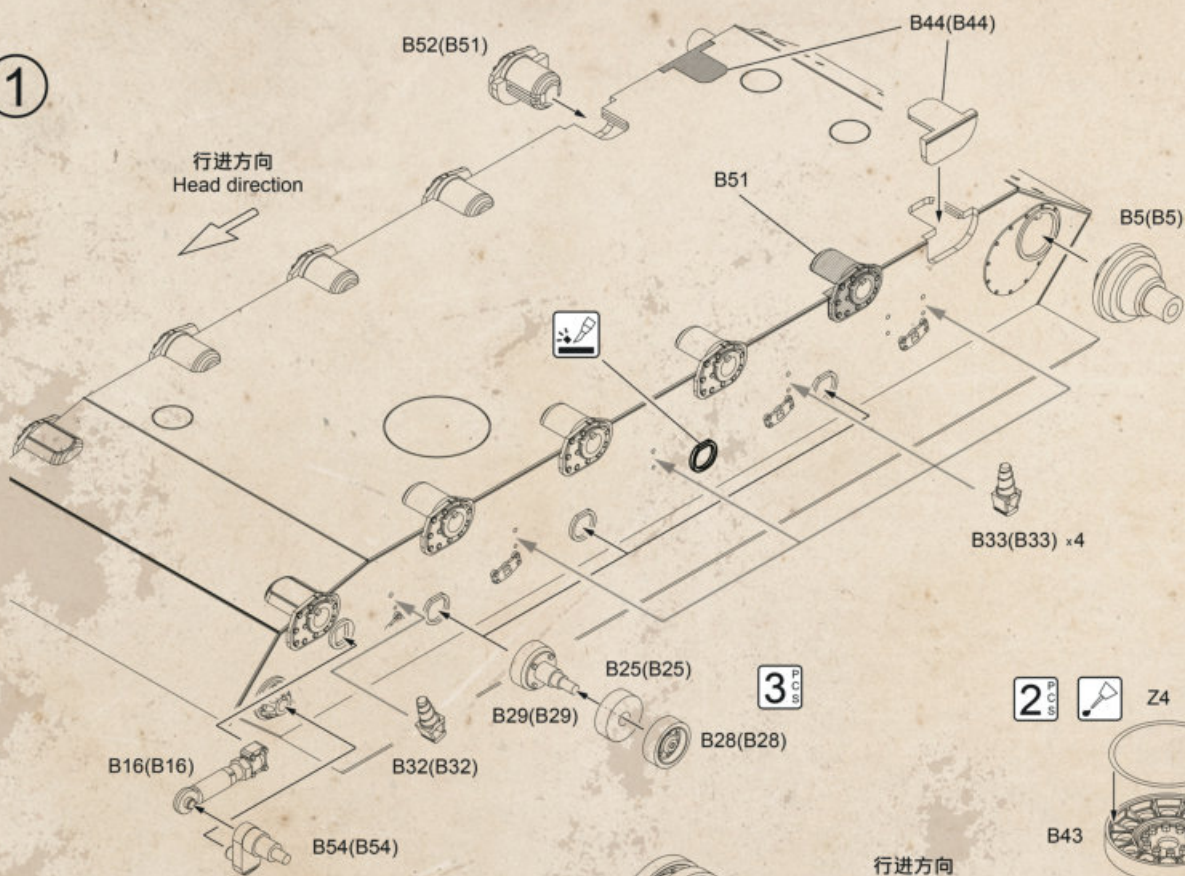

2

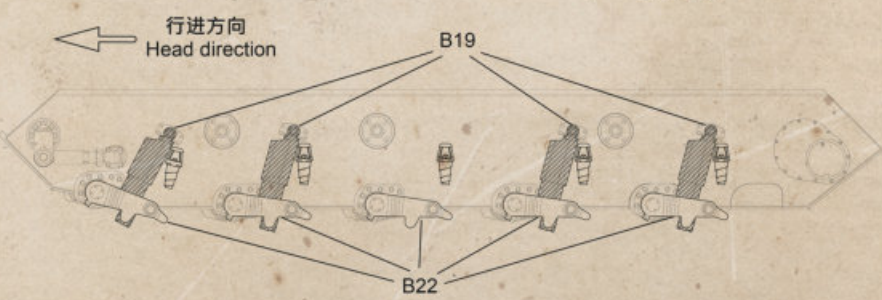
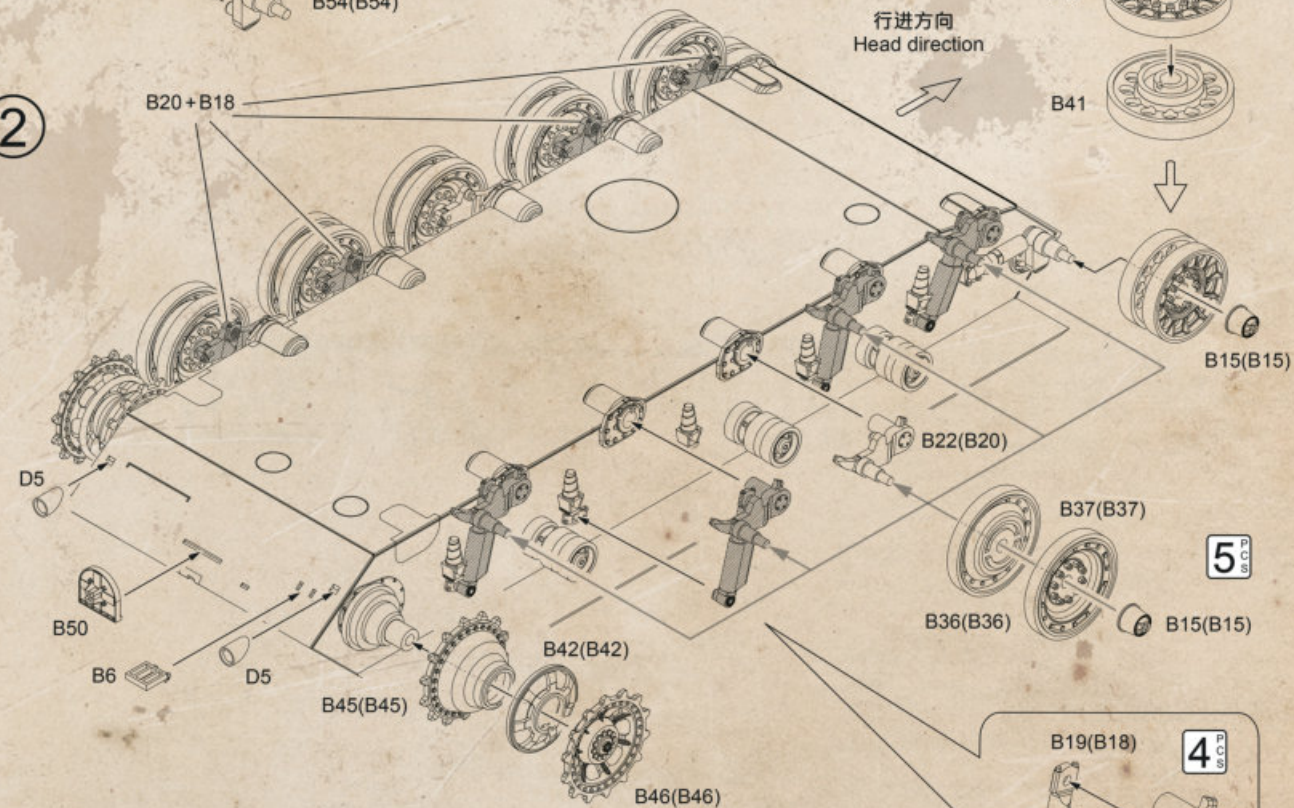

3

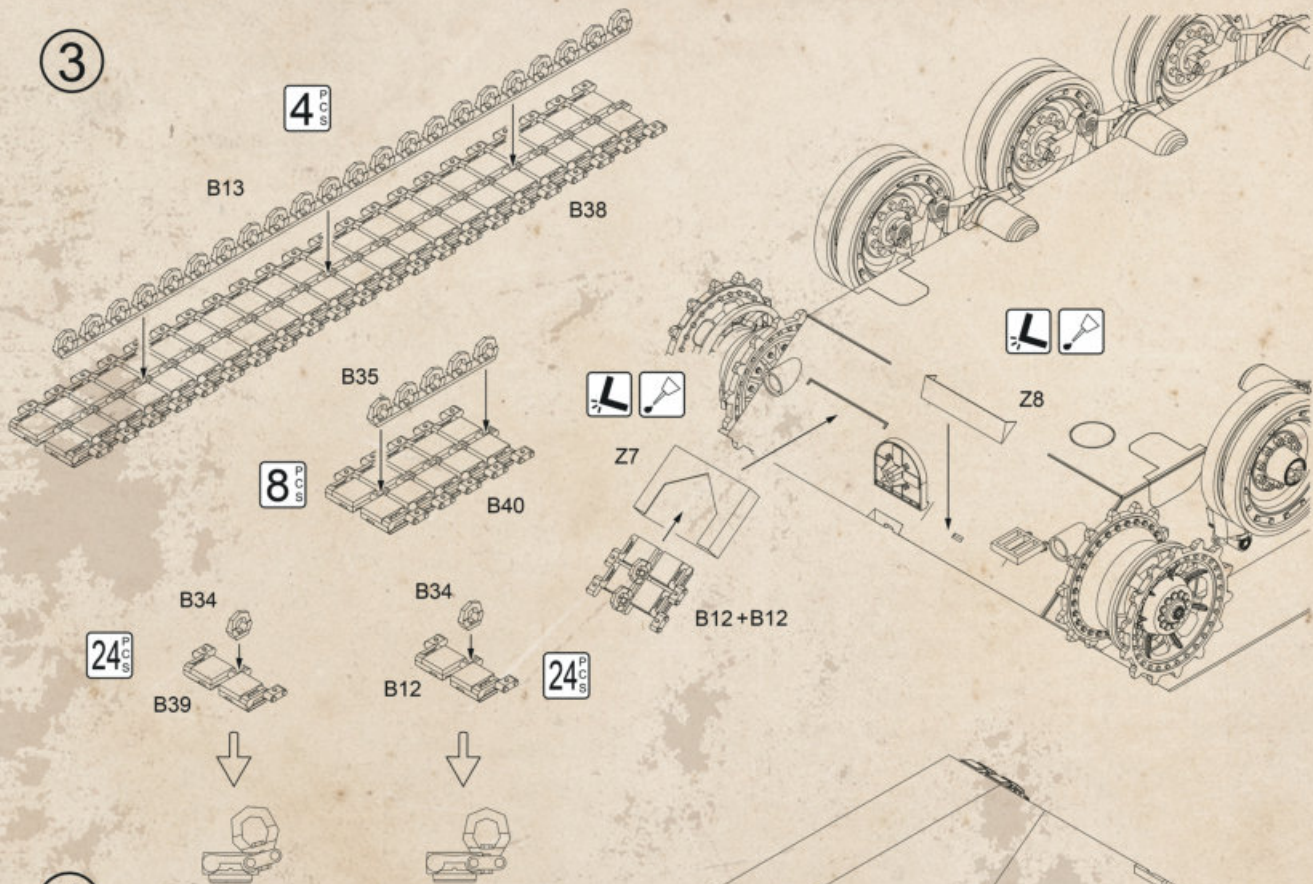

4

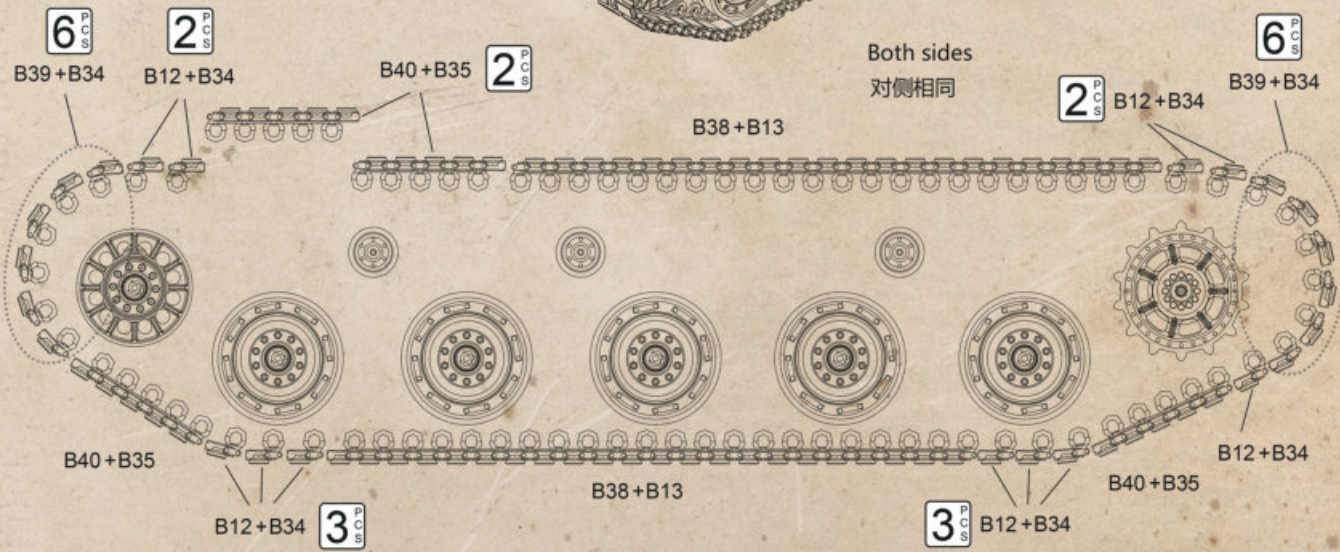
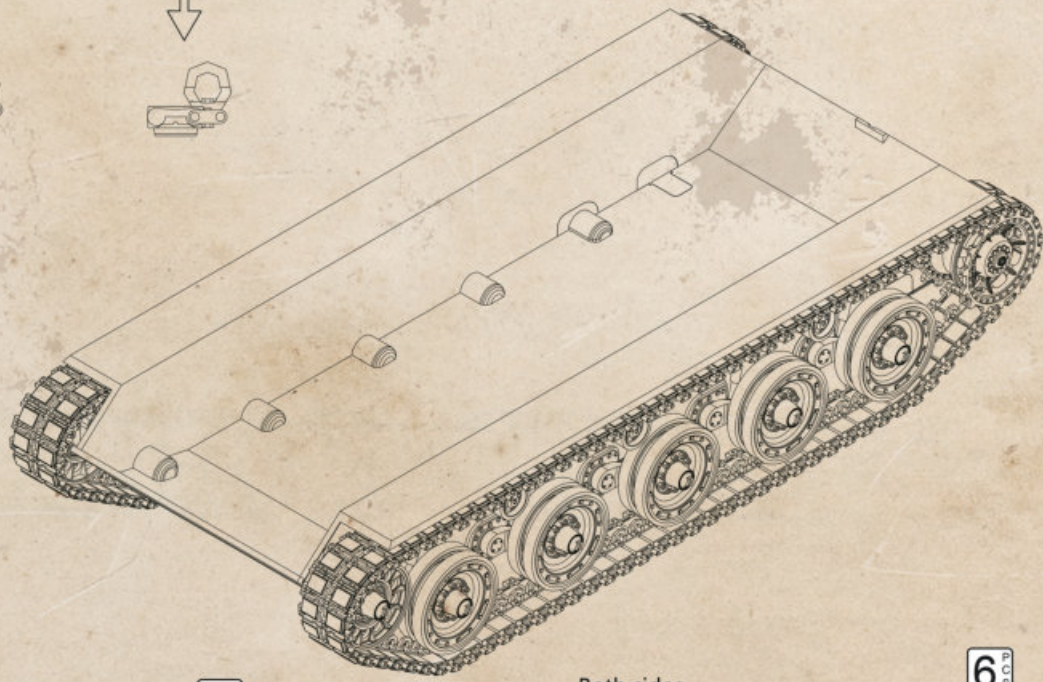

5

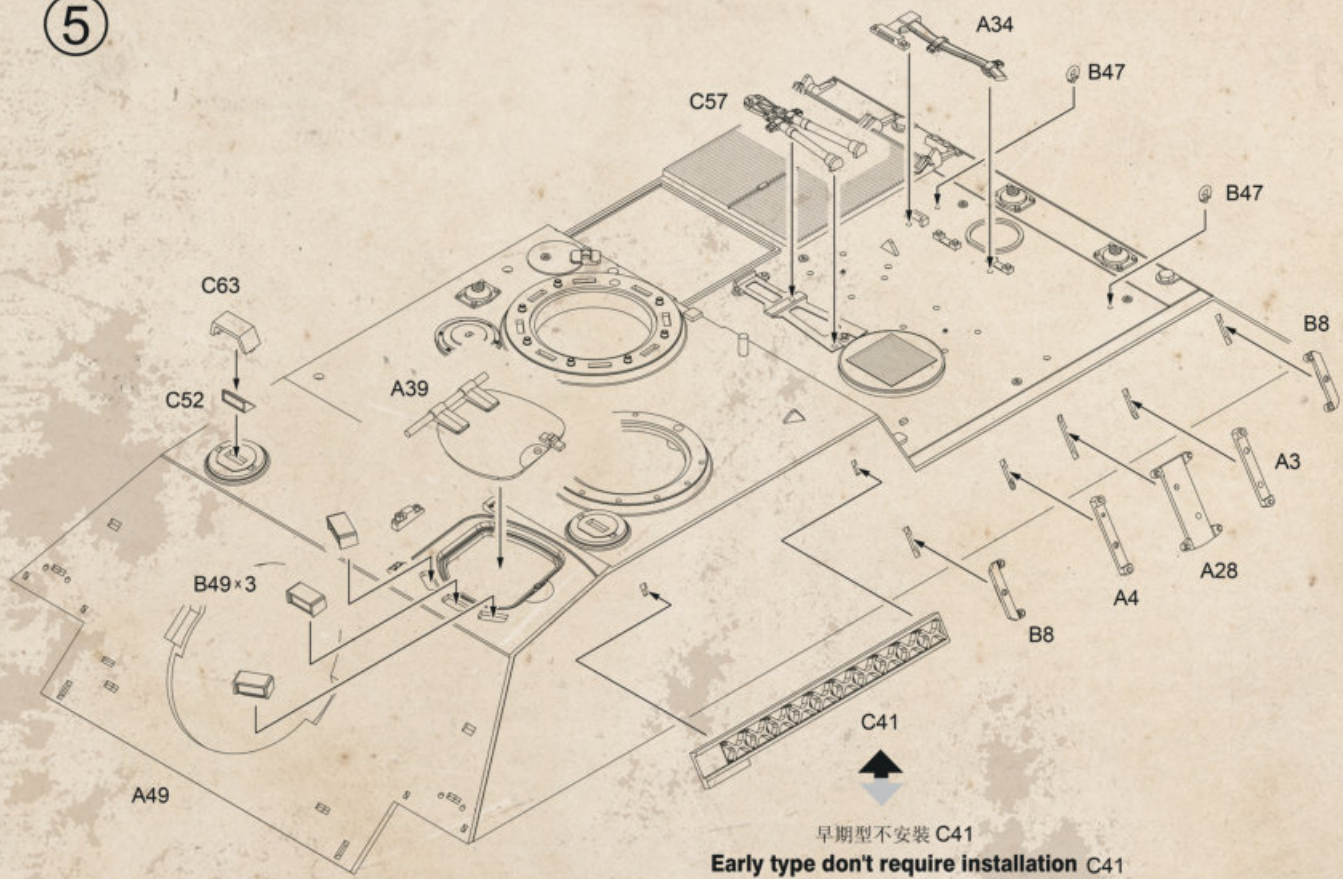

6

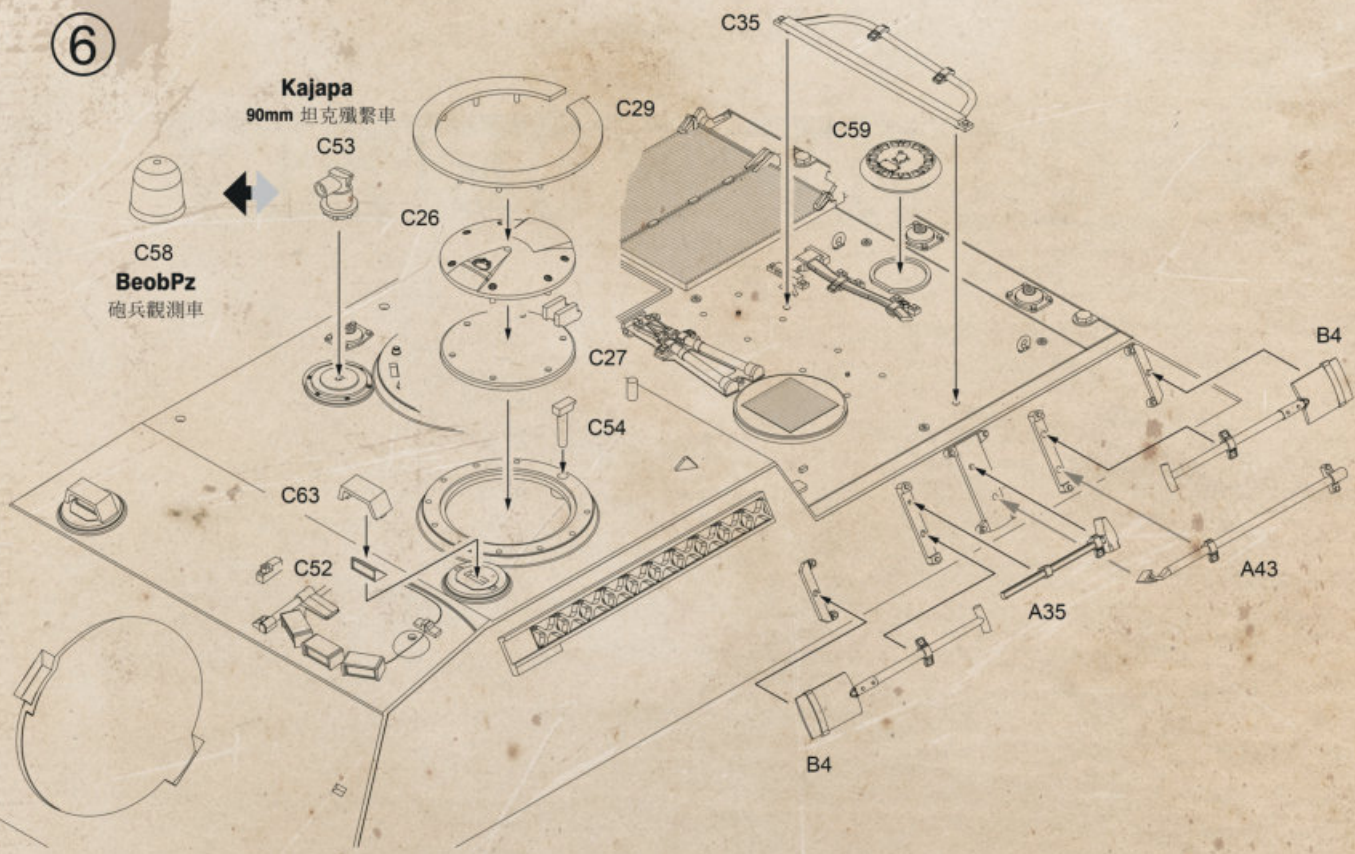

7

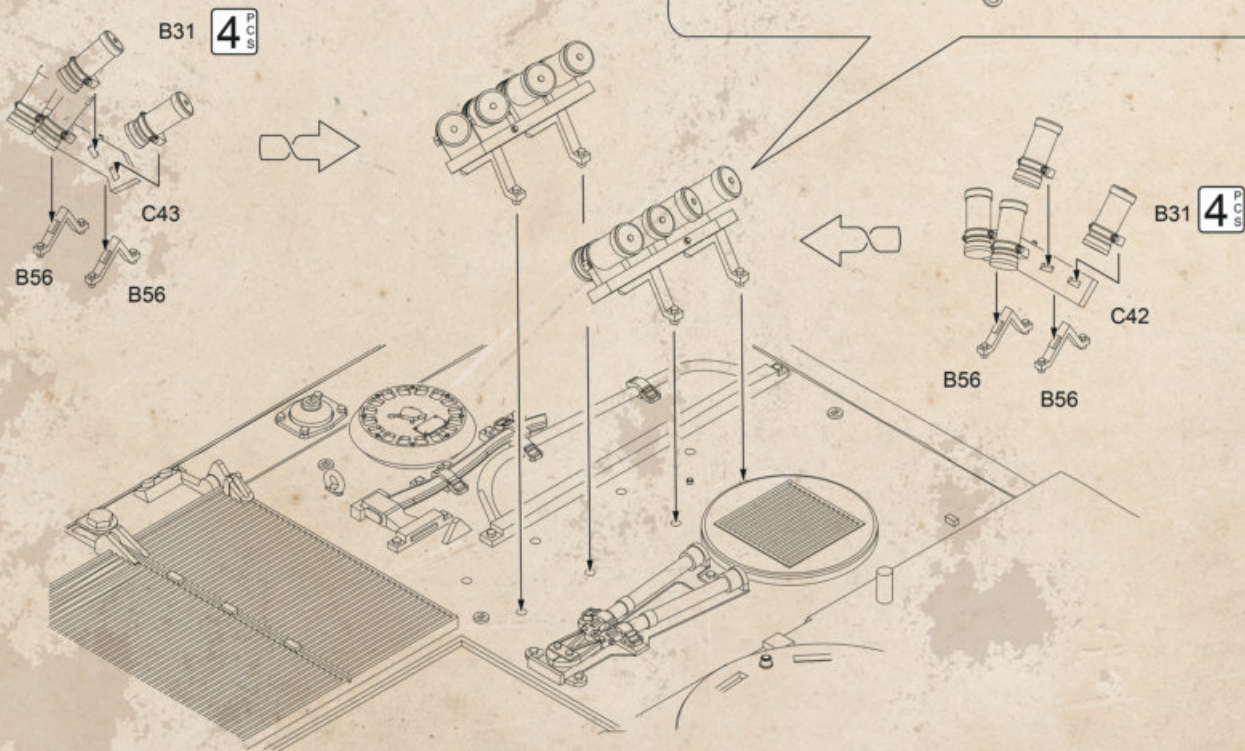

8

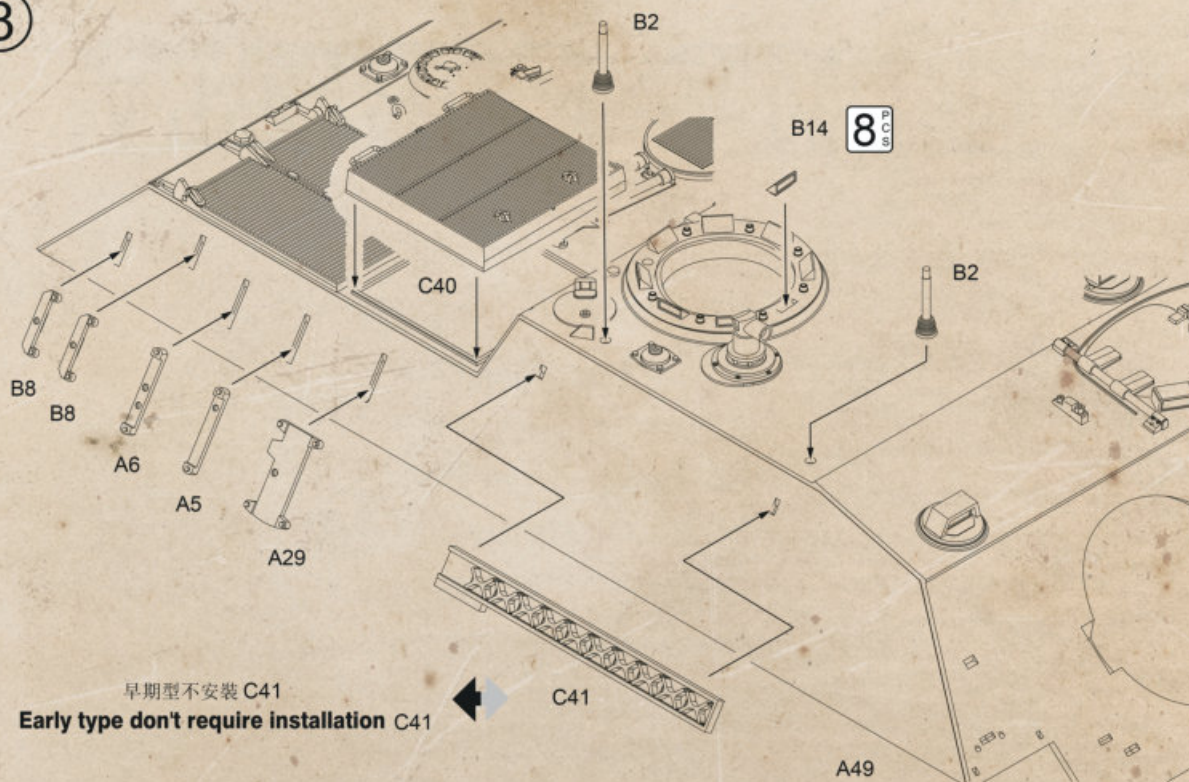

9

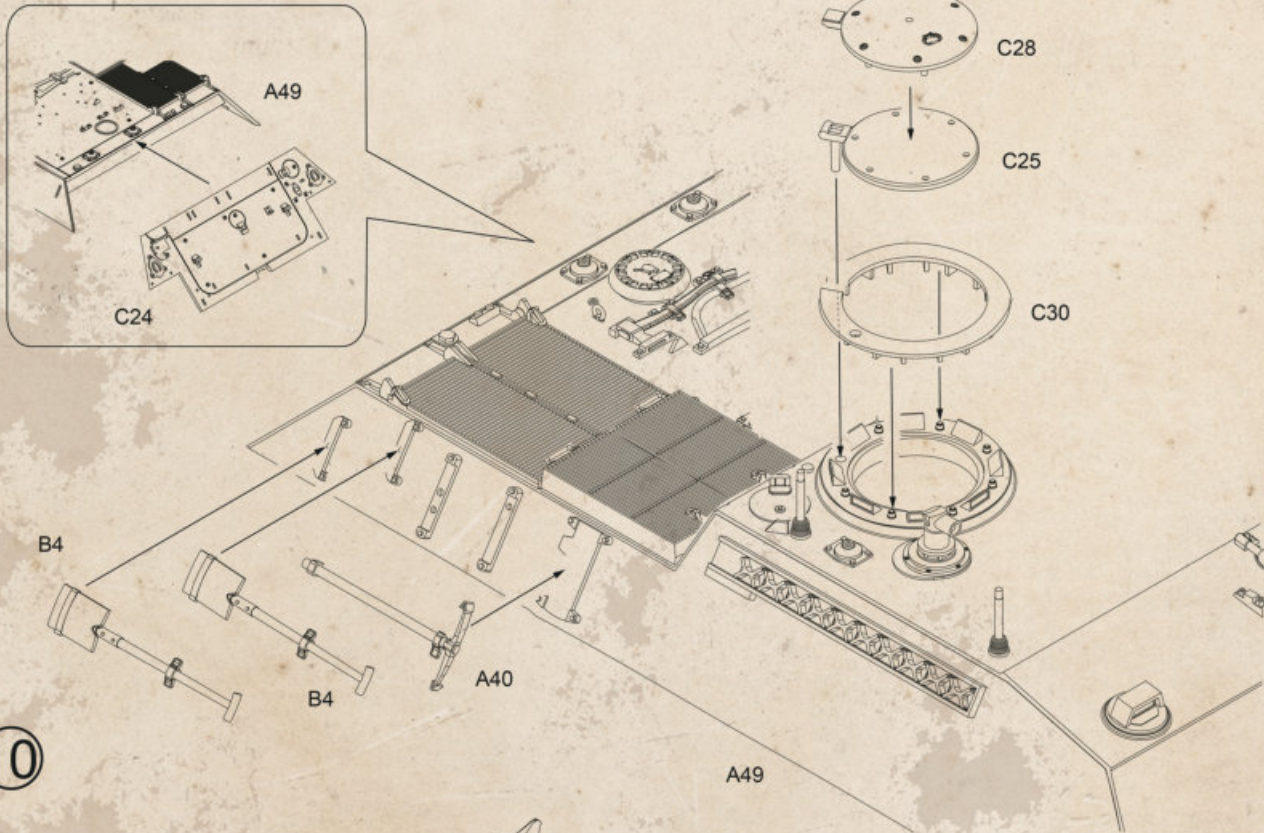

10

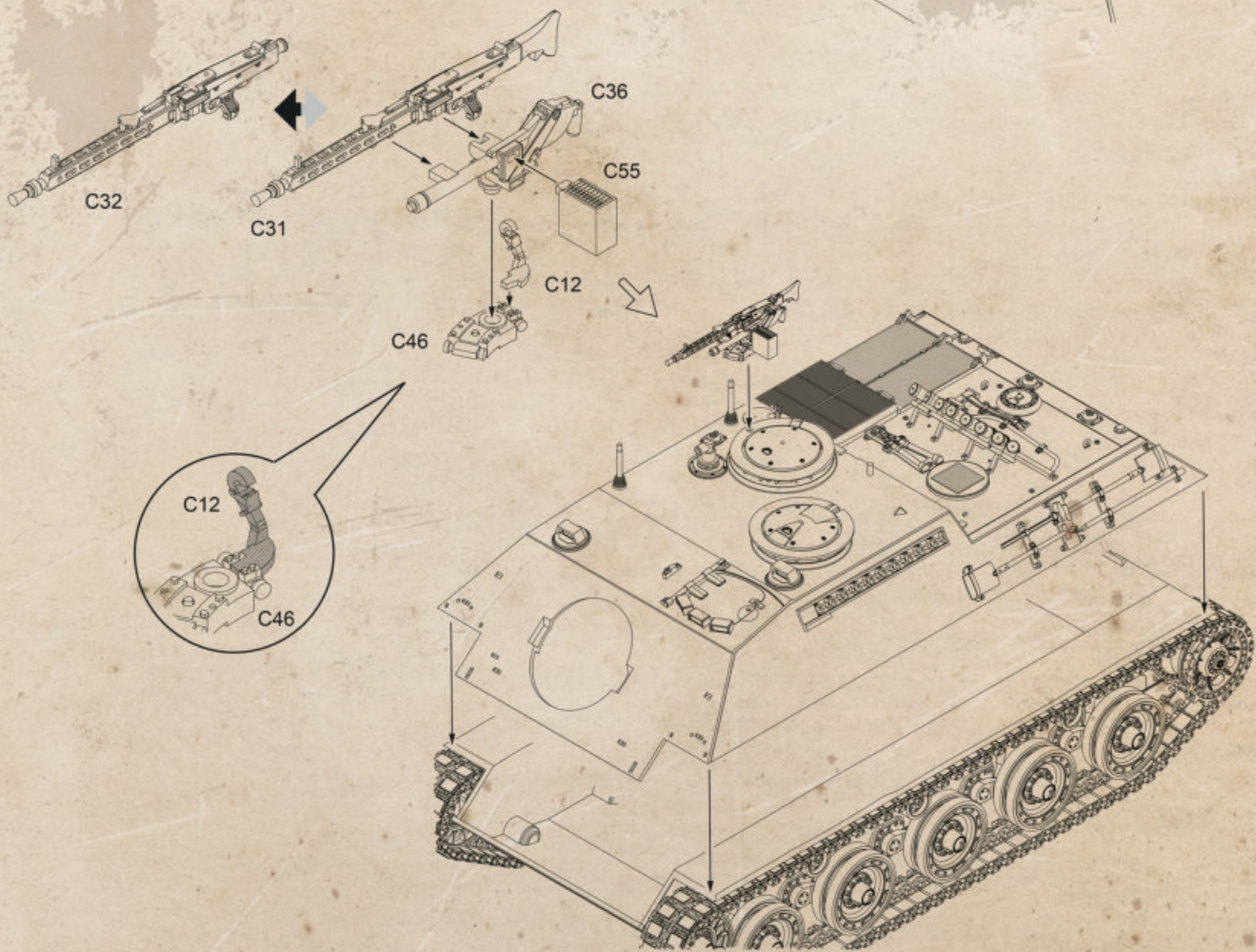

11

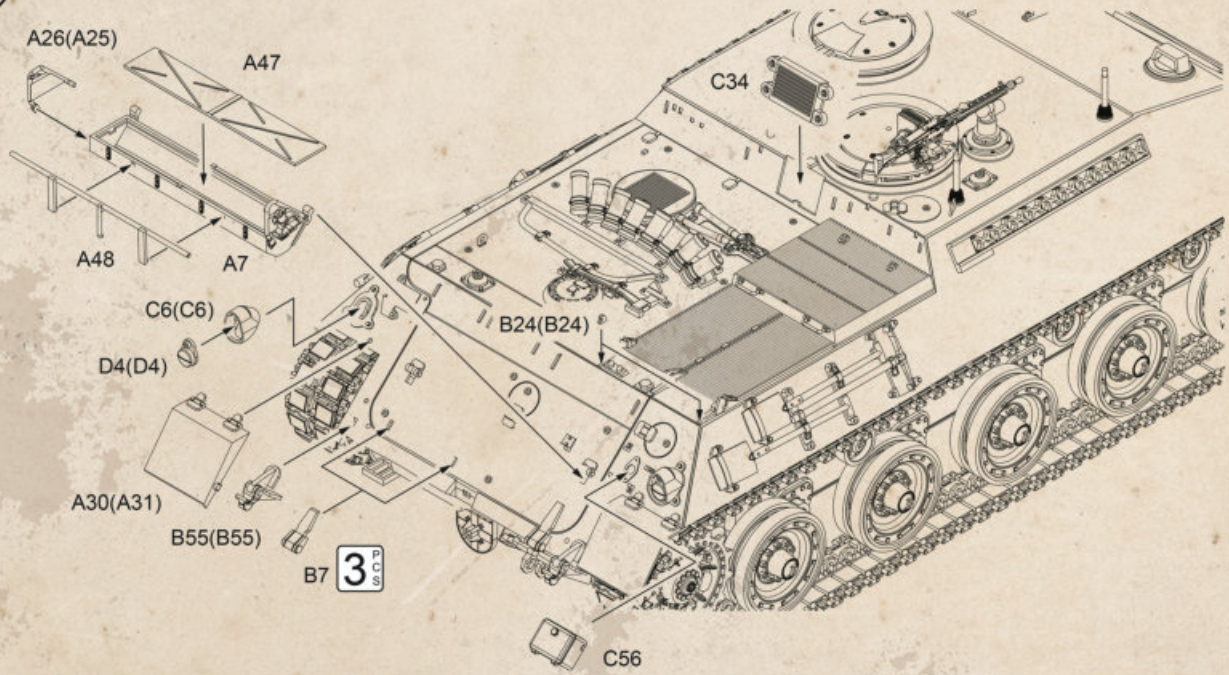

12

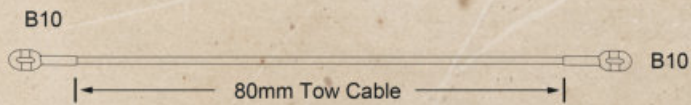
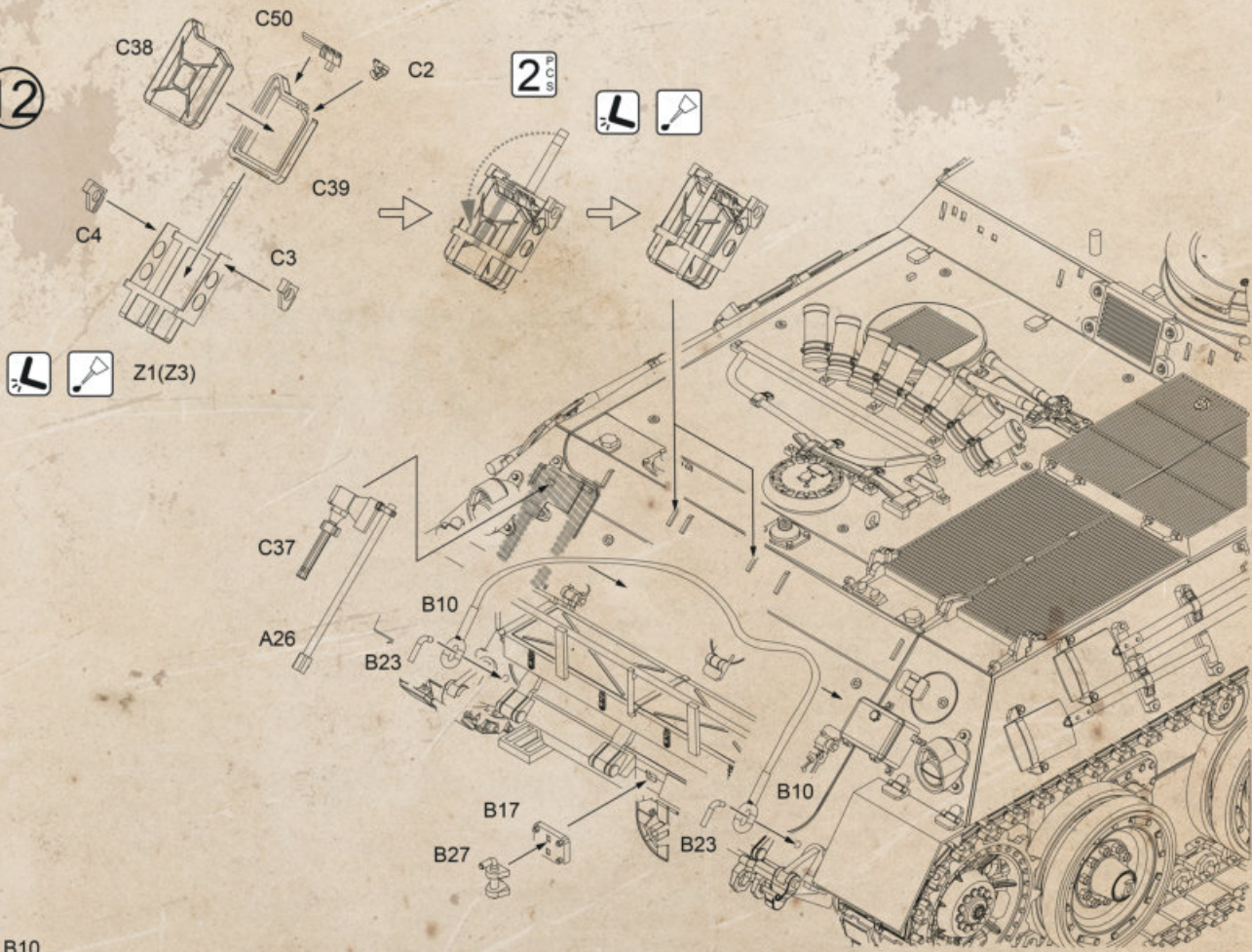

13

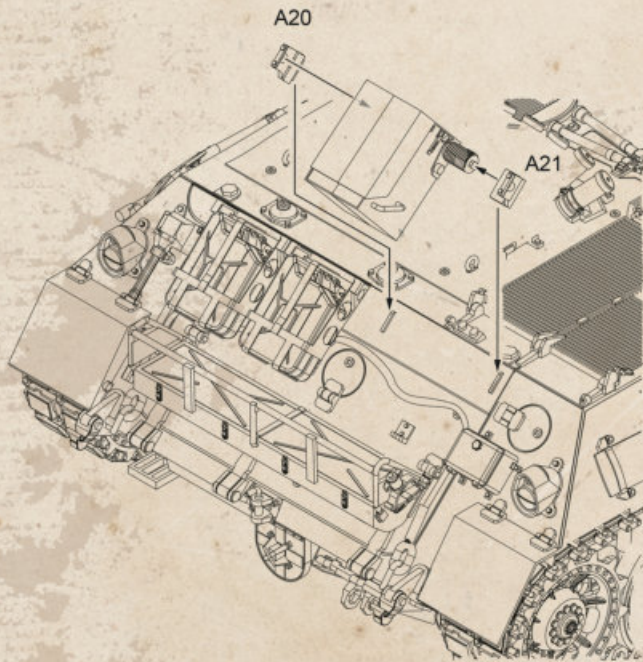

Kajapa
90mm 坦克殲擊車

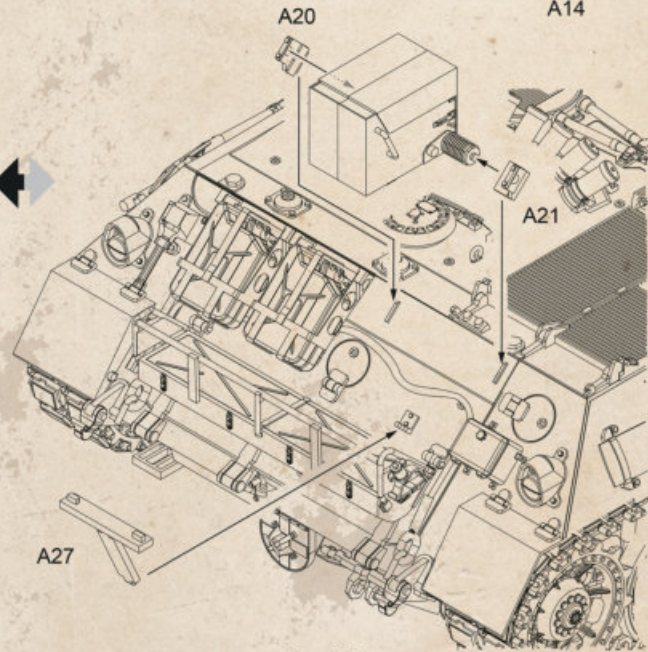
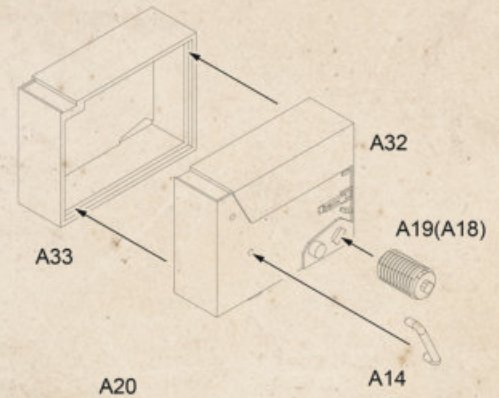

BeobPz
砲兵觀測車

14

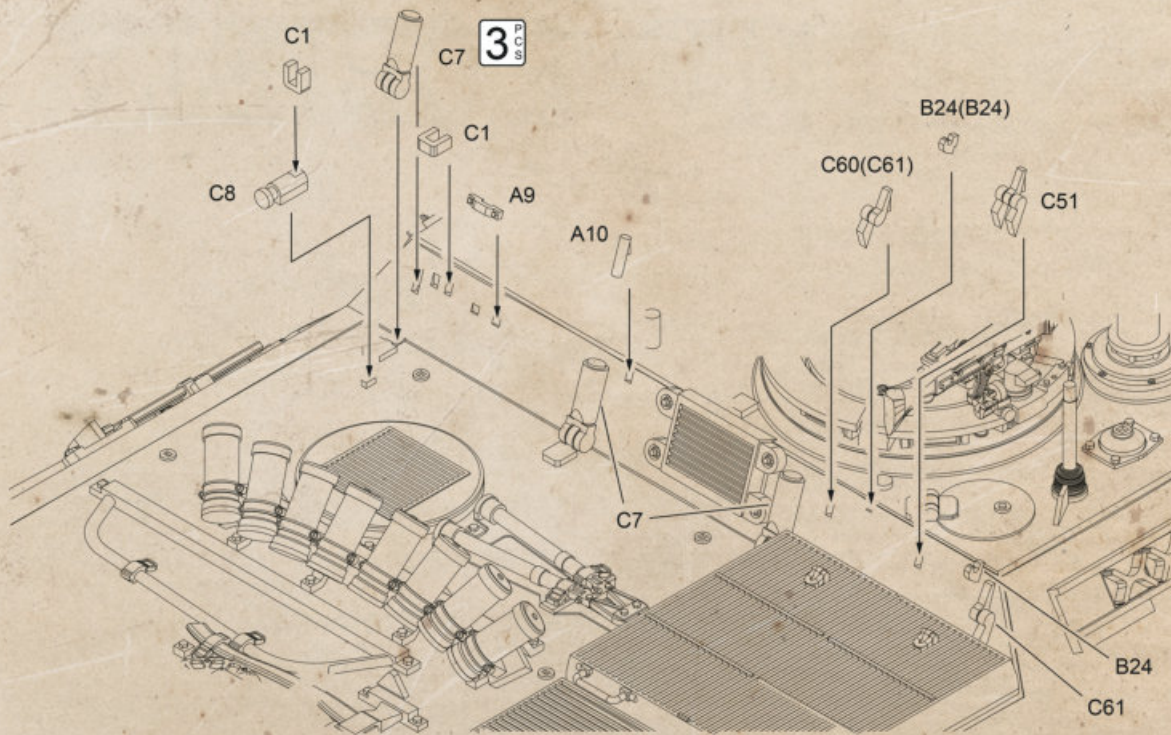

15

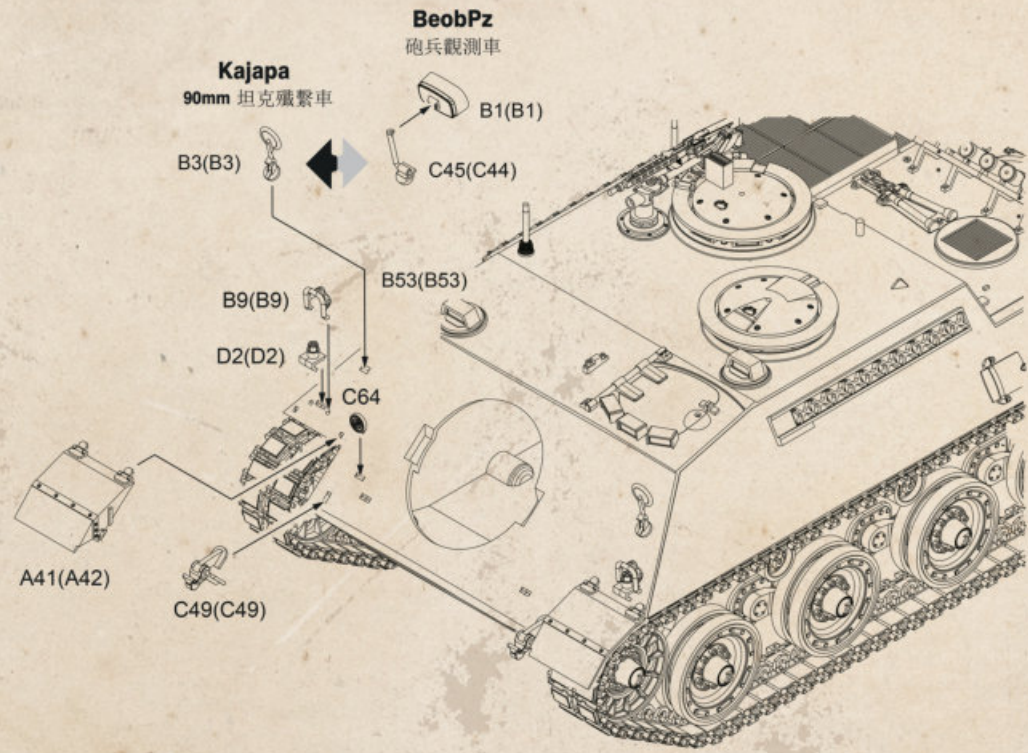

16

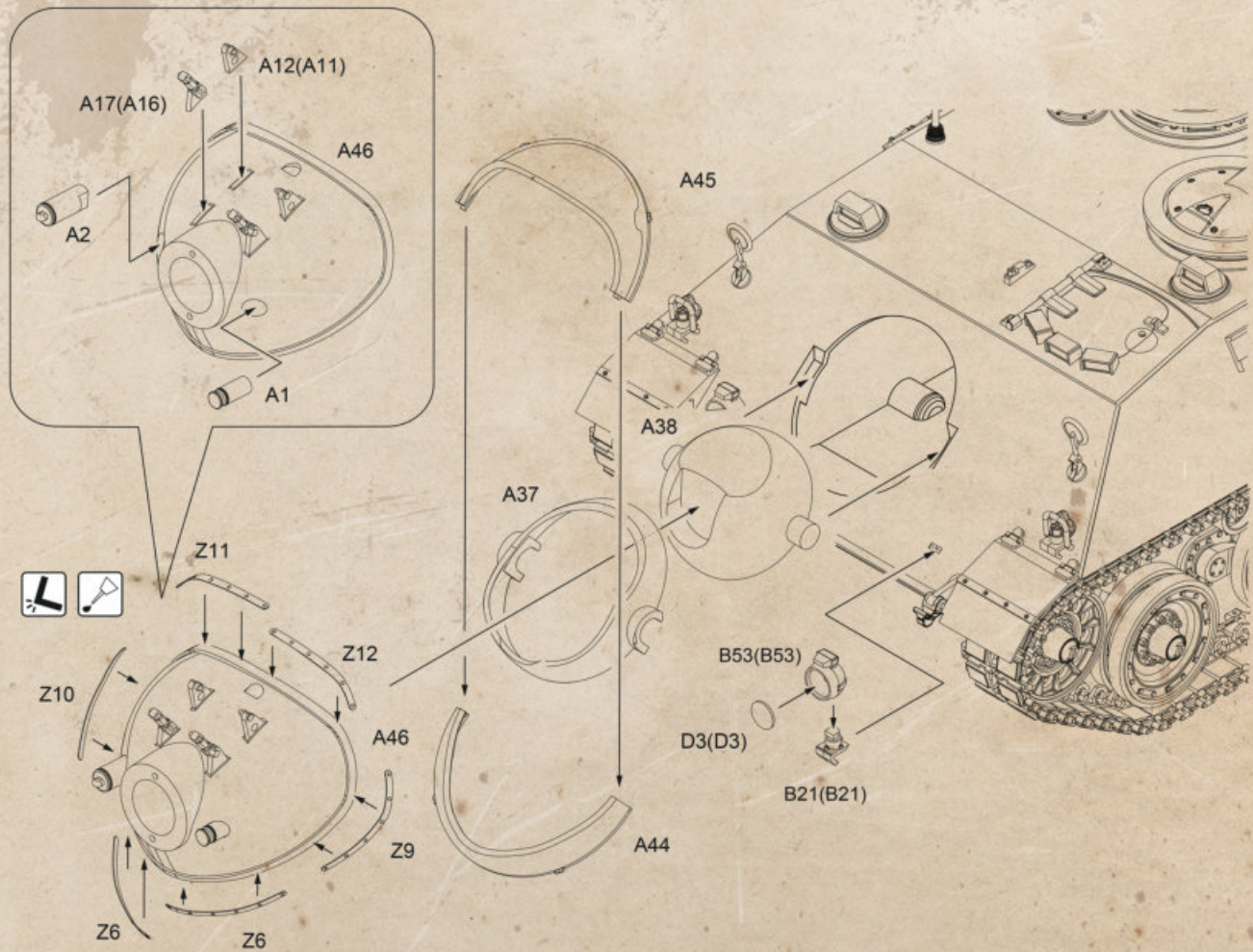

17

Kajapa
90mm 坦克殲擊車

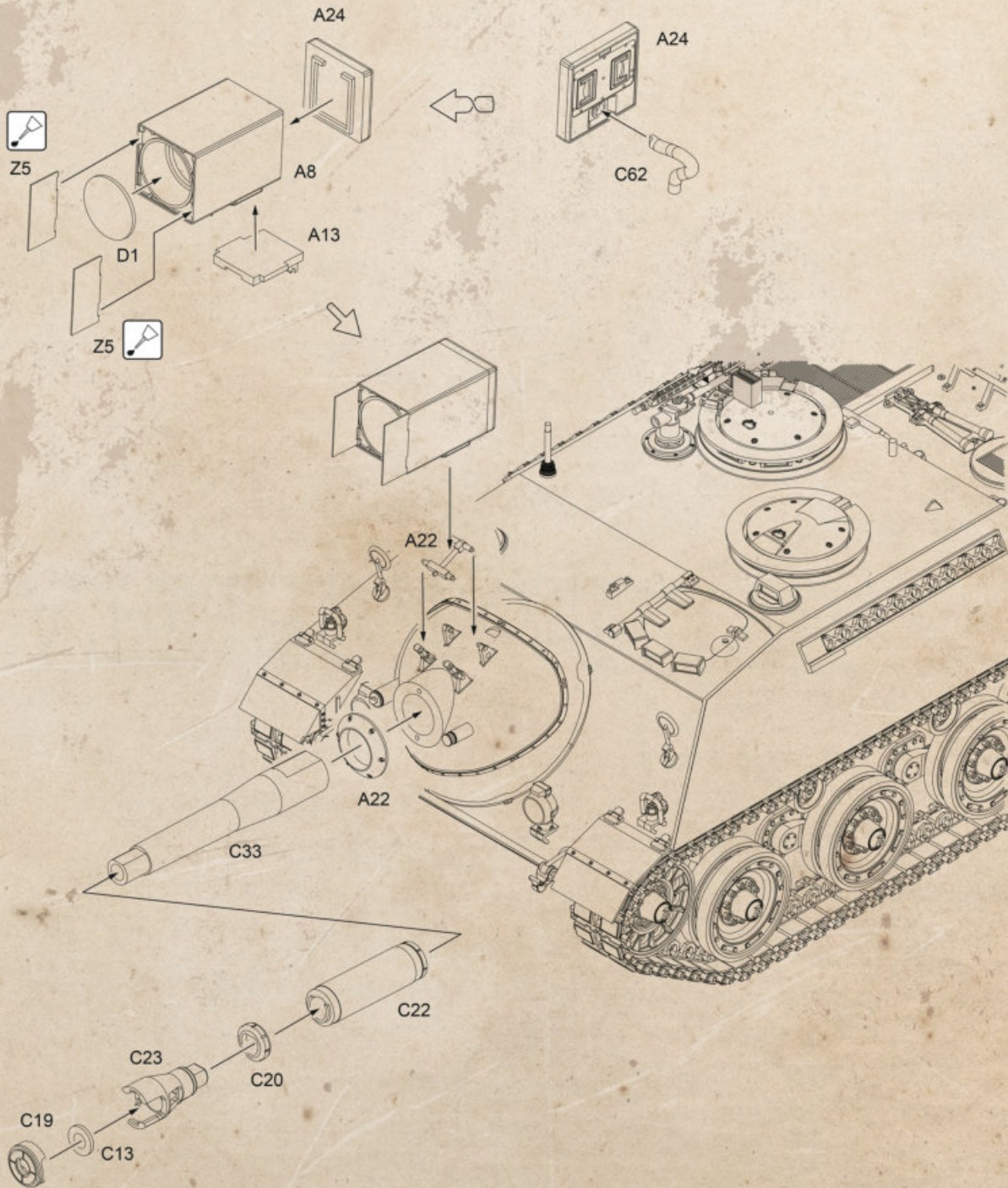
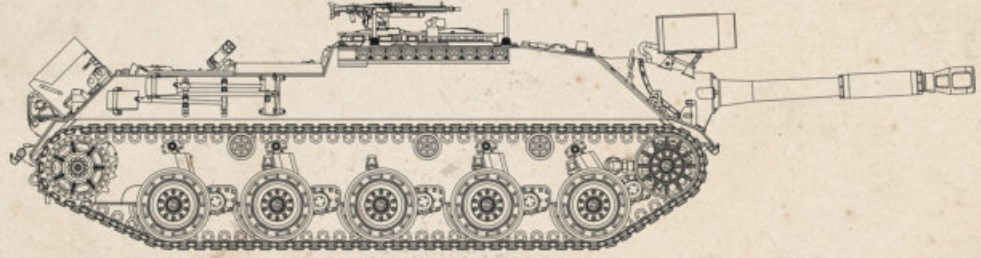

18

BeobPz
砲兵觀測車

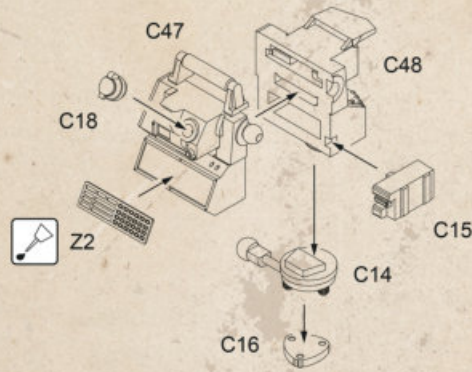
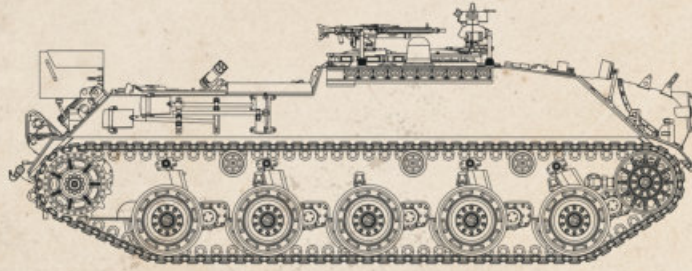

TZG 90 Mobile Target Detection System

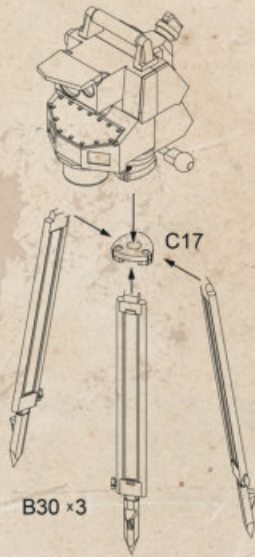

B30 x3

C17

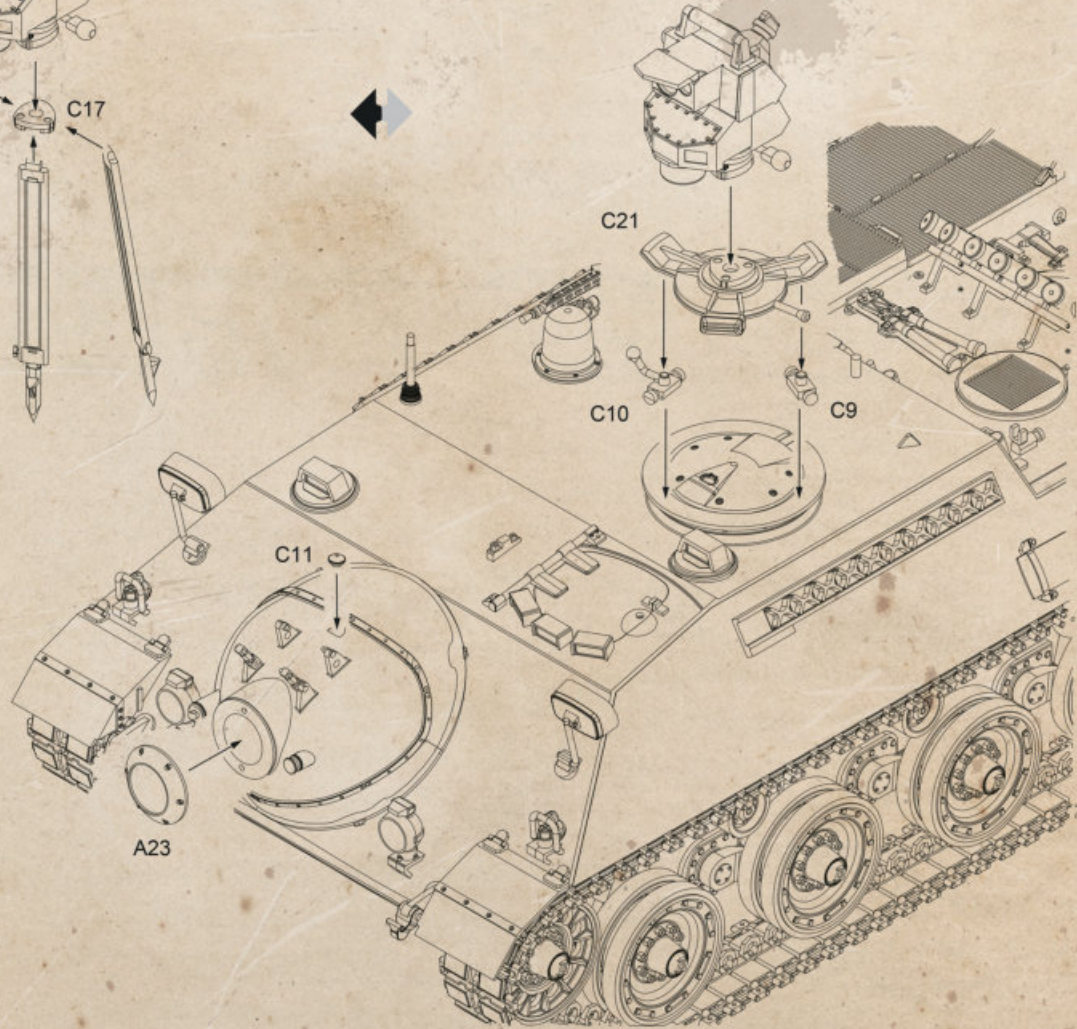



Kanonenjagdpanzer

Profiles by:



Painting and Marking Guide

5./PzGrenLBtl.21, Hannover, early 1970s

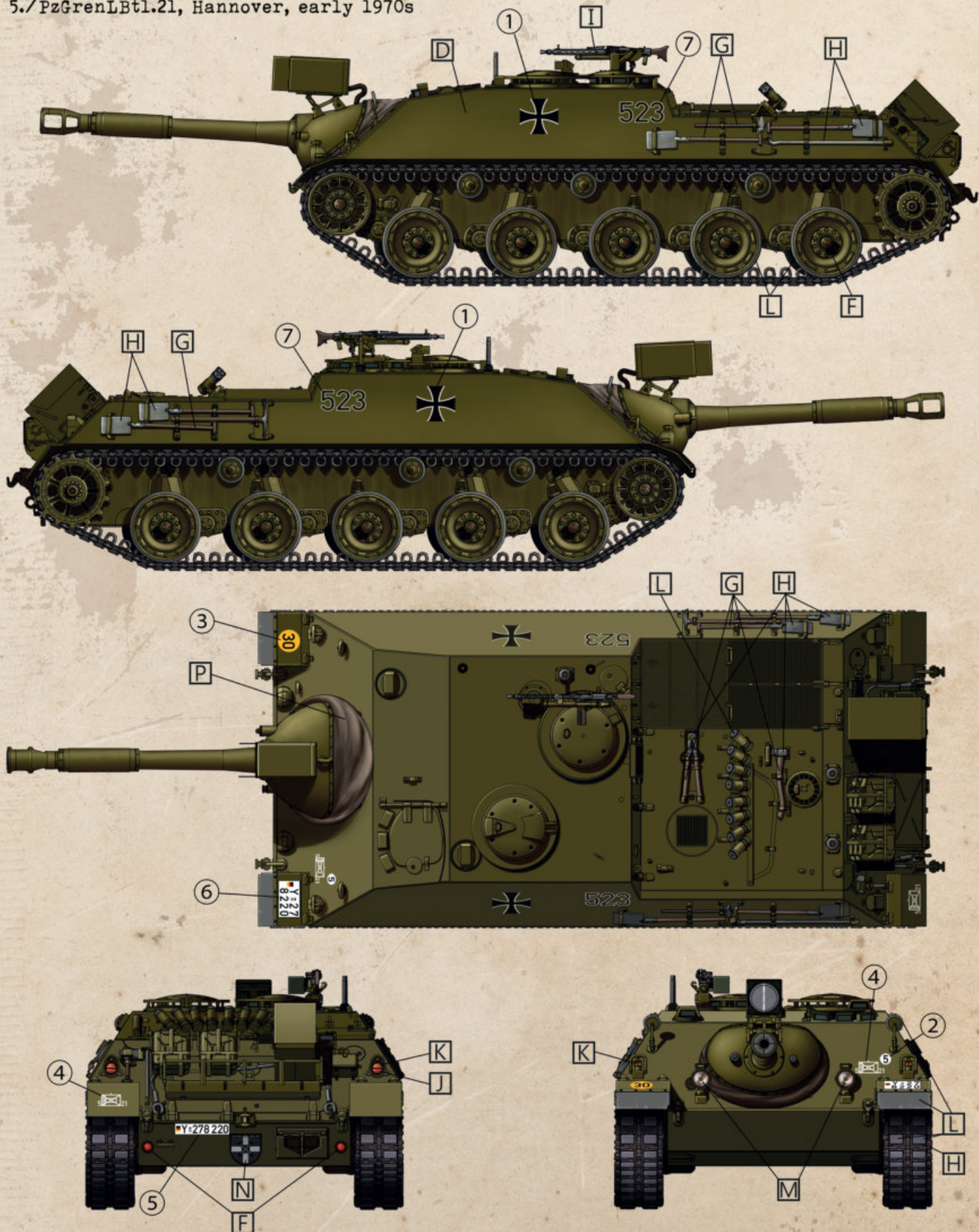



Kanonenjagdpanzer

Profiles by:



Painting and Marking Guide

PzJgKp.130, REFORGER 85 "Central Guardian", Schwalmstadt area





Kanonenjagdpanzer

Profiles by:



Painting and Marking Guide

PzJgKp.160, Schwarzenbek, 1984





Beobachtungspanzer

Profiles by:



Painting and Marking Guide

PzGrenBtl.32, Nienburg, mid 1990s

