

Russian Su-30MKK Flanker G

俄罗斯Su-30MKK “侧卫” G战斗机

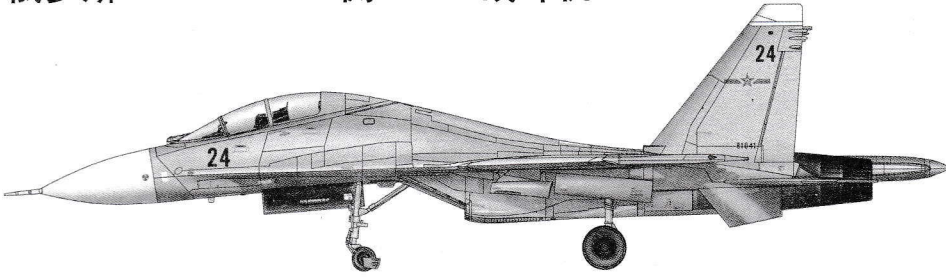

READ BEFORE ASSEMBLY:

- Study and understand these instructions thoroughly before beginning assembly
- When needed, remove photo-etch parts carefully using a modeling knife or photo etch sprue cutter, being careful not to damage or lose small parts.
- Take extra care in handling photo etch parts in order to avoid injury
- Apply instant cement sparingly to photo etch parts where instructed
- Tools recommended(not included in kit):Plastic and instant cements, sprue cutters,long nose pliers,modeling knife, small files, tweezers, pin vise & scissors. Soft cloth and sandpaper will also assist in construction
- Glue and paint are not included in the kit. Use plastic cement and hobby paints only. Color guide for purchasing paint is included in the kit.

装配之前仔细阅读

- 小心用模型锉刀锉平所有零件表面的注射浇口。
- 小心用刀片切下蚀刻片零件，不要遗失小零件。
- 用强力快干胶水粘合蚀刻片零件和金属轴。过量快干胶水使用可能导致可动零件会粘住，小心涂胶。
- 取蚀刻片时应特别注意安全，防止利边划伤手指。
- 某些零件表面需贴水上贴纸，请选择在装配的同时进行。
- 推荐模型工具(自备)：胶水，水口剪刀，长咀钳，刀片，锉刀，镊子，钳，钻，剪刀，瞬间快干胶。
- 软布同砂纸同时也应该是必备工具。
- 请使用塑料胶水和油漆，模型内不含。



配重
Weight



使用强力胶
Cyanoacrylate glue



钻孔
Make hole



切除
Cut / Remove



贴纸
Decal



锉平
File / Sand



选择
Option



不涂胶水
No cement



弯曲
Bend

水贴纸的使用:

- 1.从水贴上剪下印花;
- 2.将印花放入温水中浸10秒, 然后放在干净布上。
- 3.拿着印花纸板将印花移到模型上;
- 4.手指蘸水将印花移到适当的位置;
- 5.用软布轻压印花直至水干, 汽泡消失

DECAL APPLICATION

- 1.Cut decals from sheet as needed
- 2.Dip the decal in warm water for about 10 seconds and then place on soft clean cloth.
- 3.Hold the decal backing sheet edge and gently slide the decal onto the model in its proper position.
- 4.While still wet,decal can be adjusted for better fit on model by dampening it gently with your finger.
- 5.When placed in the proper position,gently press decal down with a soft cloth until excess water and air bubbles are gone.
- 6.Allow decal to dry completely before handling model

部品图
Parts

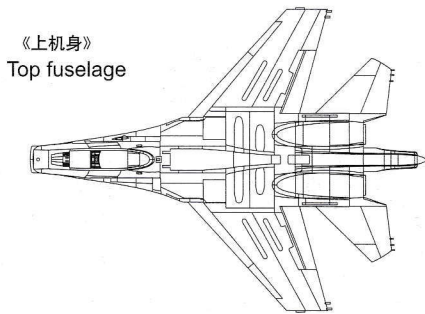
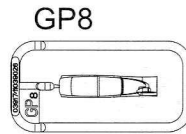
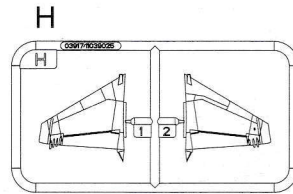
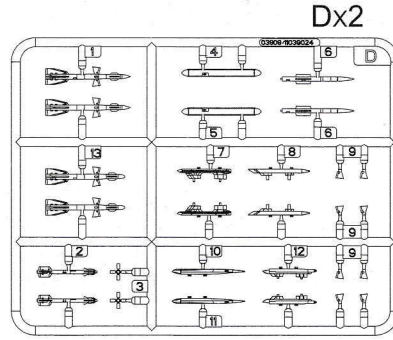
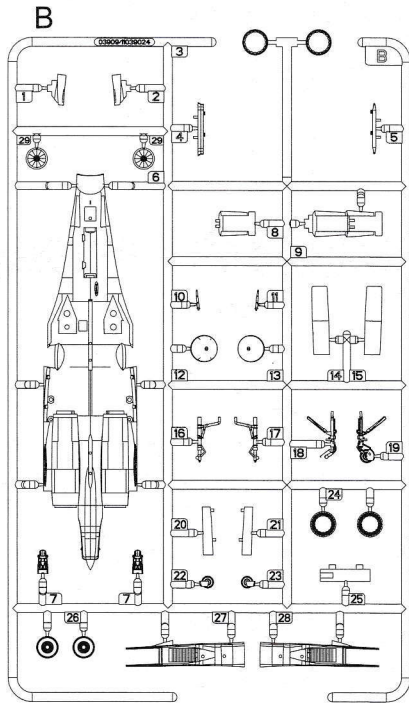

《水贴》
Decal

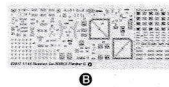

不用的部件: B3 B8 B10 B12 B19
Unused parts

1

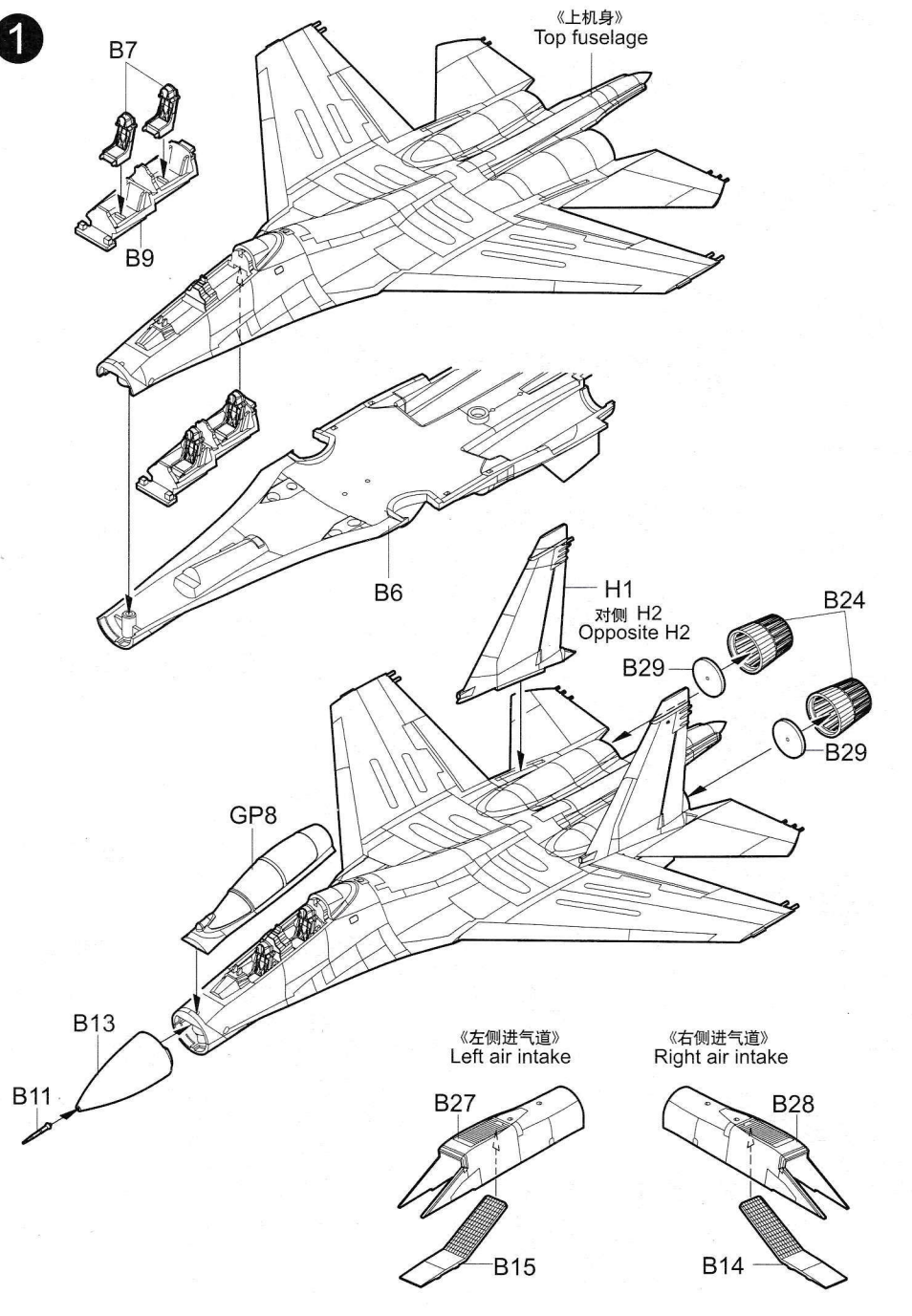

03917

3

2

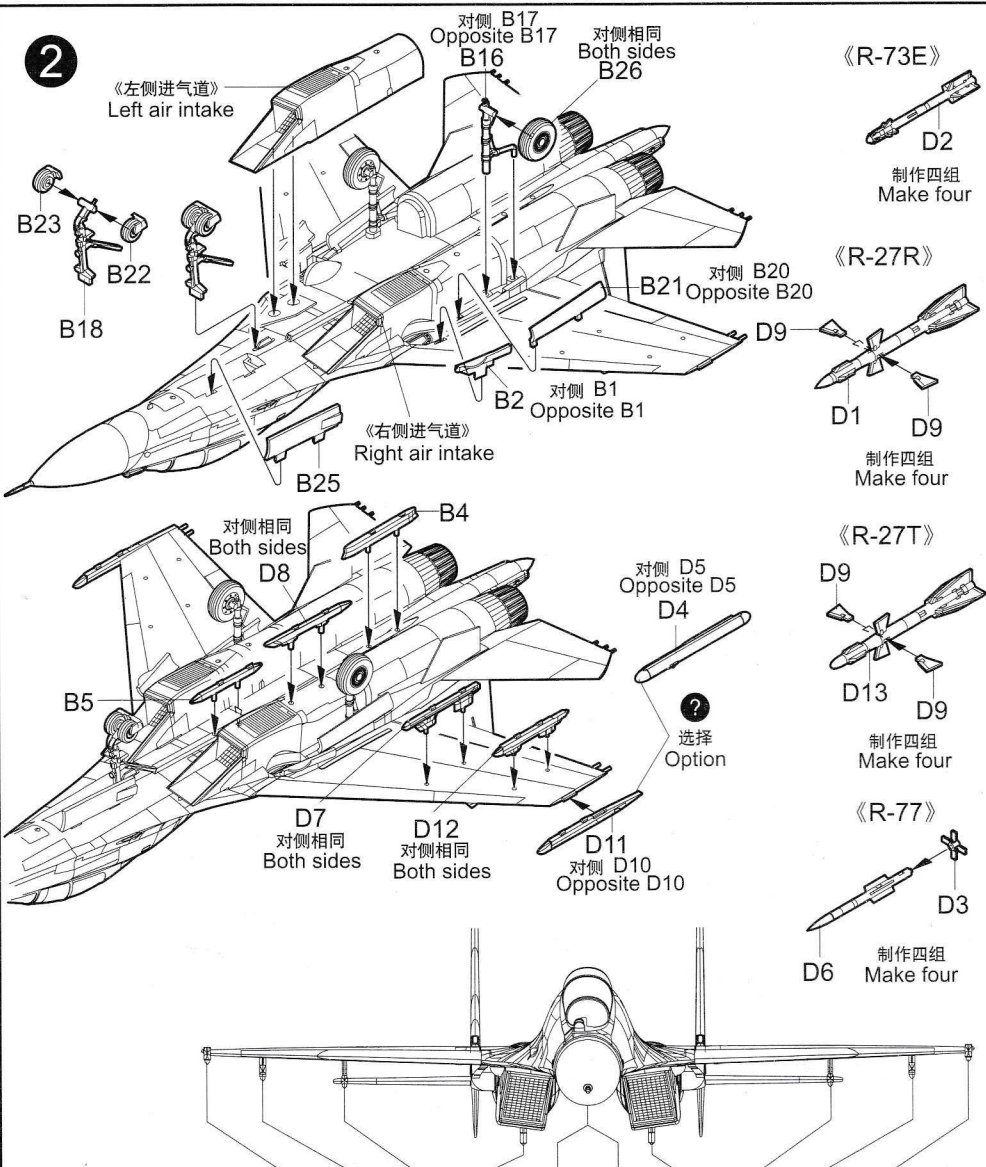

Sta.No.	1	2	3	4	Front	Back	7	8	9	10
Missile/Tank										
R-73E	●	●		●	●	●	●	●	●	●
R-27R			●	●	●	●	●	●		
R-27T			●	●	●	●	●	●		
R-77		●	●					●	●	

涂装同标贴指示 Painting & Marking guide

A

PAINT REFERENCE COLOUR					
Color	Mr.Hobby	Vallejo	Model Master	Tamiya	Humbrol
红色 Red	H 3 3	908	1503	X7	19
银色 Silver	H 8 8	997	1546	X11	11
烧铁色 Burnt Iron	H 76 61	863	1795	X10	53
胎黑色 Tire black	H 77 137	-	-	-	-
透明红 Clear Red	H 90 47	934	-	X27	-
透明绿 Clear Green	H 94	936	-	X25	-
白色 White	H 1 1	842	1745	XF2	22

PAINT REFERENCE COLOUR					
Color	Mr.Hobby	Vallejo	Model Master	Tamiya	Humbrol
黑棕色 Metal Brown	H 18 28	864	1402	-	-
灰白色 Aircraft Gray	H 57 73	-	-	-	-
灰色 Light Gray	H 338 338	907	1732	XF14	147
浅机灰色 Light Aircraft Gray	H 332 332	-	-	-	166
白色 White Insignia	H 316 316	991	1745	X2	22
薄松叶色 Light Green	H 319 319	-	1713	-	117
烟灰色 Smoke Blue	H 96 101	-	-	-	-

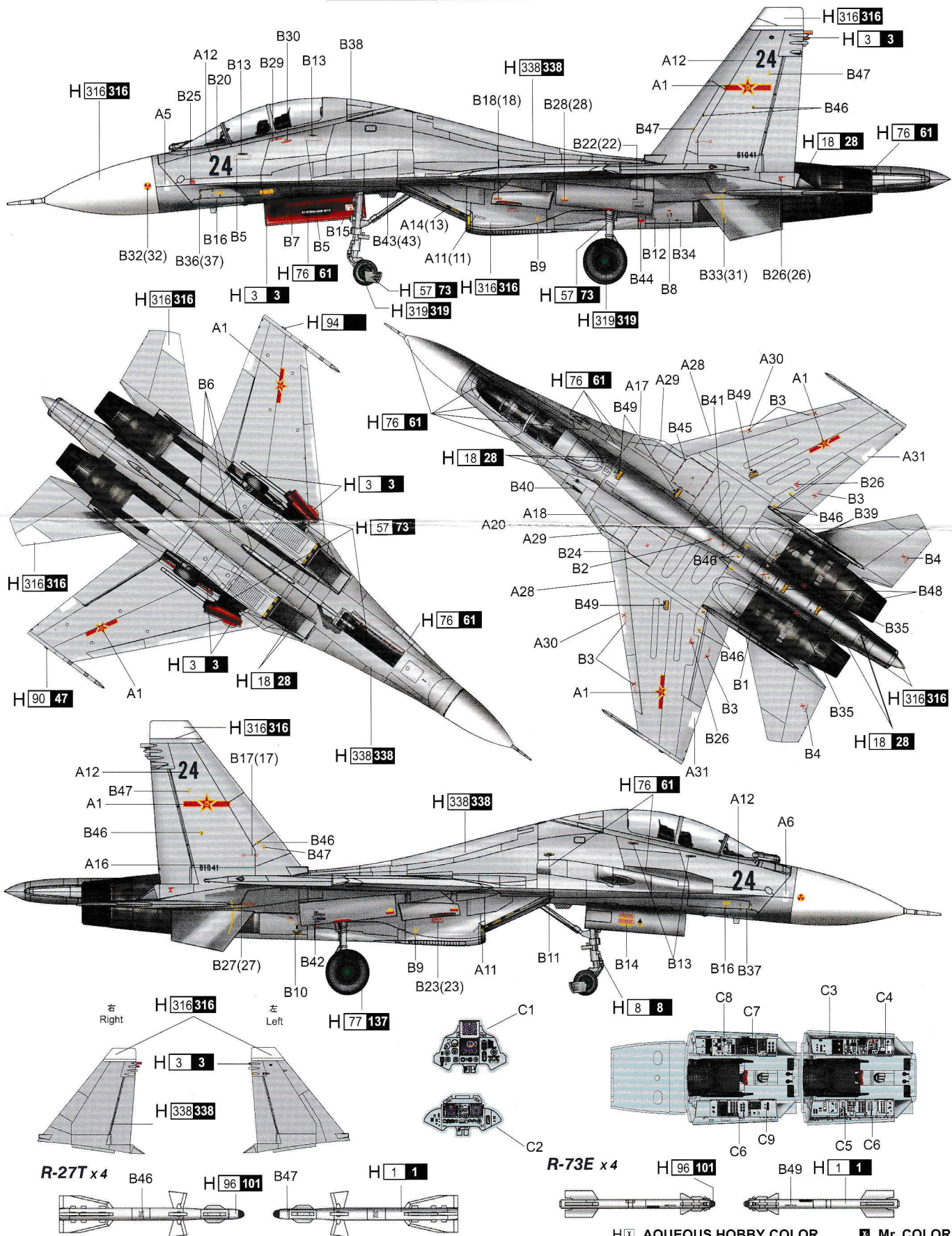

涂装同标贴指示
Painting & Marking guide

B

PAINT REFERENCE COLOUR					
Color	Mr.Hobby	Vallejo	Model Master	Tamiya	Humbrol
红色 Red	H 3 3	908	1503	X7	19
银色 Silver	H 8 8	997	1546	X11	11
烧铁色 Burnt Iron	H 76 61	863	1795	X10	53
胎黑色 Tire black	H 77 137	—	—	—	—
透明红 Clear Red	H 90 47	934	—	X27	—
透明绿 Clear Green	H 94	936	—	X25	—
深灰色 Medium Gunship Gray	H 305 305	868	1723	XF58	125

PAINT REFERENCE COLOUR					
Color	Mr.Hobby	Vallejo	Model Master	Tamiya	Humbrol
黑铁色 Metal Brown	H 18 28	864	1402	—	—
灰白色 Aircraft Gray	H 57 73	—	—	—	—
浅灰蓝色 Grayish Blue	H 337 337	—	1721	XF20	145
浅机体色 Light Aircraft Gray	H 332 332	—	—	—	166
白色 White Insignia	H 316 316	991	1745	X2	22
薄荷叶色 Light Green	H 319 319	—	1713	—	117
白色 White	H 1 1	842	1745	XF2	22



H X AQUEOUS HOBBY COLOR X Mr. COLOR