

Messerschmitt Me 410 A-1

Gun bay & cockpit set for MONOGRAM kit

RESIN PARTS

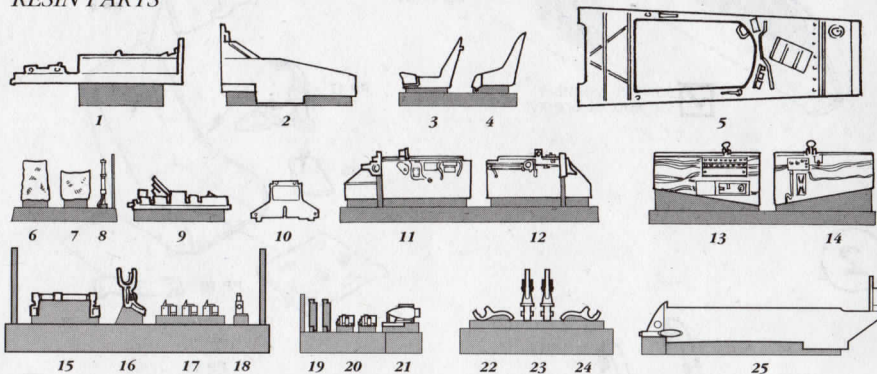
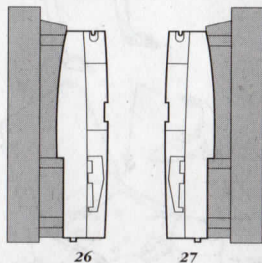
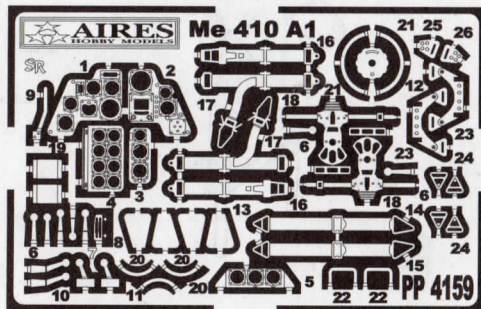
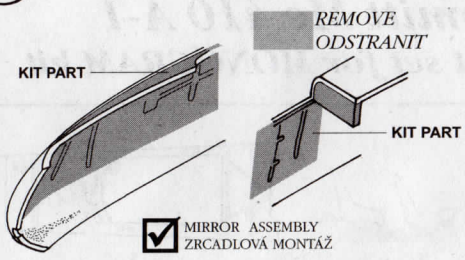

PHOTO-ETCHED METAL PARTS



Warning: Thinning of the plastic parts and dry-fitting of the assembly needed!
Upozornění: Nutno zeslabit některé plastové díly stavebnice!
Před lepením zkontrolujte dopasování dílů!

1



2

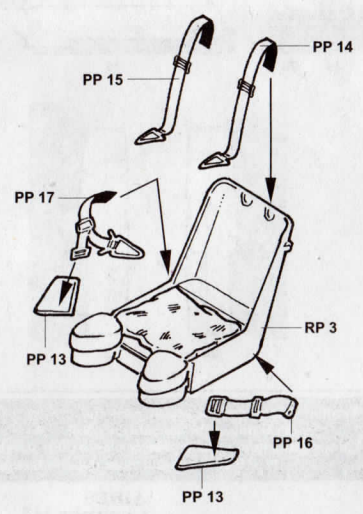

3

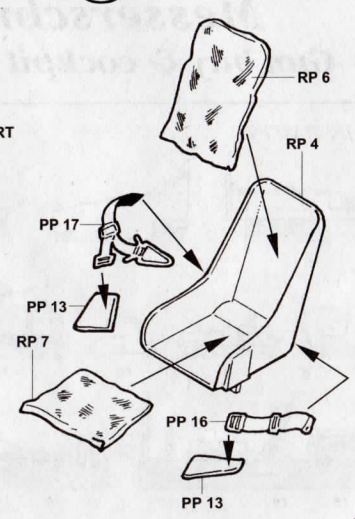

4

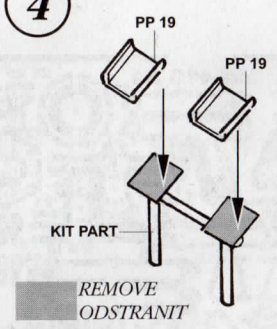

5

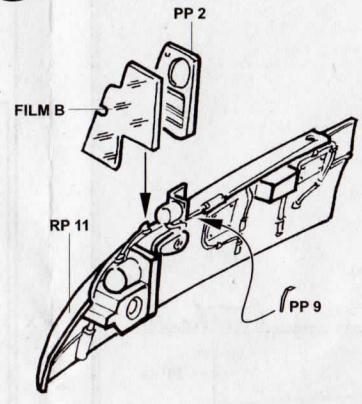

6

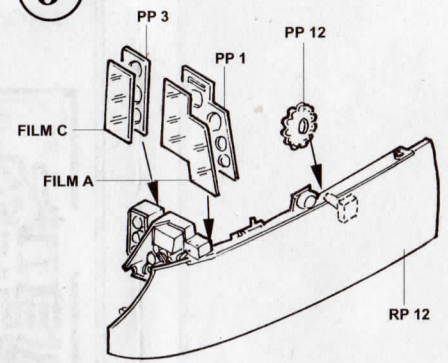

7

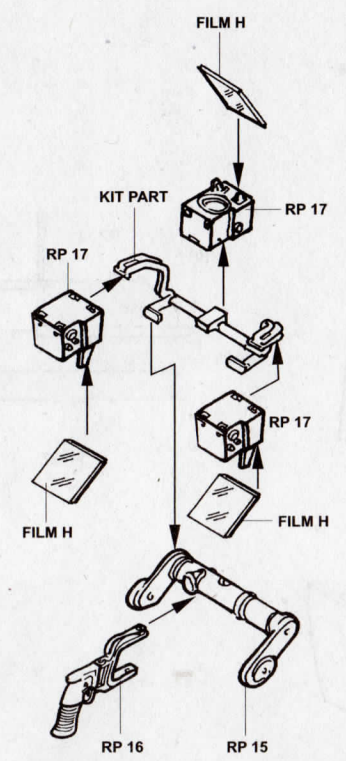

8

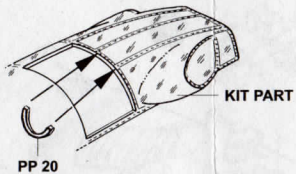

11

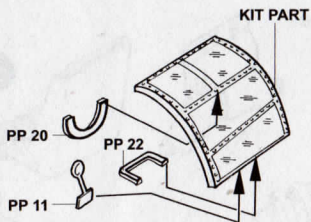

12

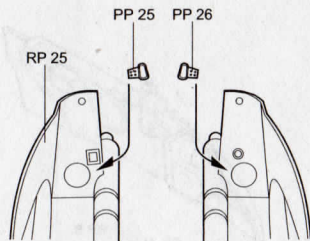

9

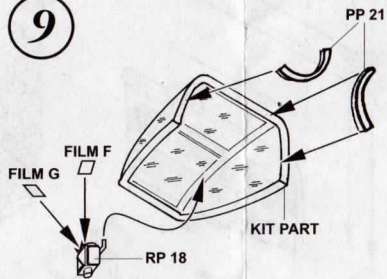

10

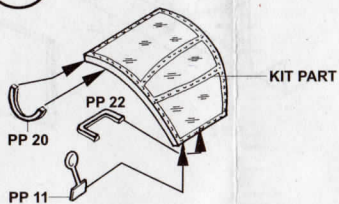

13

