

CUT

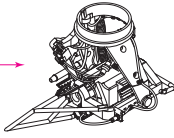

R1



DETAIL AFTER REMOVAL FROM SPRUES

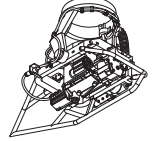
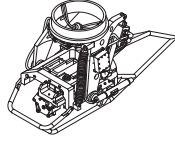
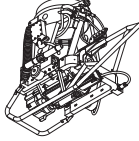

R2

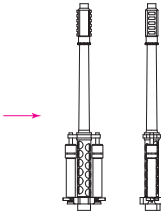

USE A SAW TO REMOVE SUPPORTS
FROM 3D PRINTED PARTS



R3

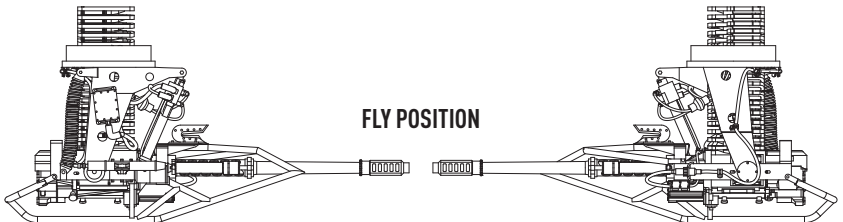
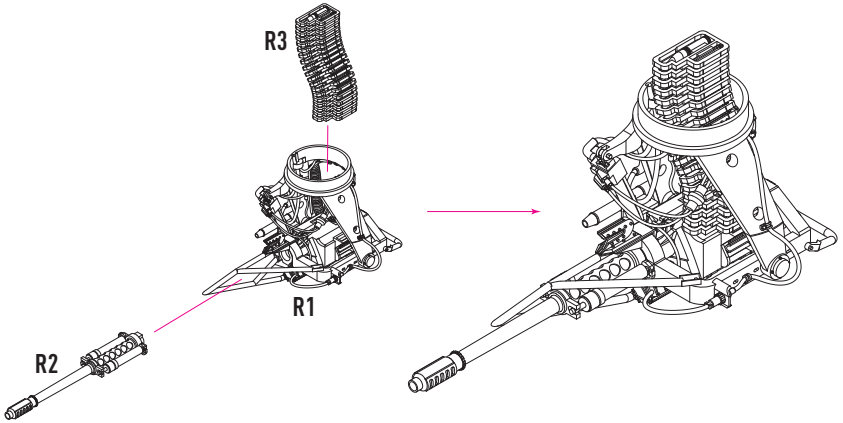

FLY POSITION

