

## HKCW CK3530 CVR(T) Scimitar, Plasan, BGTI

'Combat Vehicle Reconnaissance, Full-Track, Scimitar, Diesel, Mine and Ballistic Protected, 30 mm Gun, Bowman, BGTI' – to give it the official designation which is a bit of a mouthfull!

In preparation for *Operation Telic* (Gulf War 2, March 2003), underbelly mine protection was introduced across the CVR(T) family. By this time, all Scimitars had already gone through the LEP conversion (CK3517) to Cummins diesel power with sights upgraded to either ESPIRE (CK3516), or BGTI (CK3518) in the majority of cases, as well as Bowman radio (CK3519). The underbelly mine protection (SMM3529) was the first step in improving the vehicle's protection which later included the introduction of the Israeli-developed perforated armour from the Plasan company.

This is the first combi-kit from HKCW and SMM which includes most of the above-mentioned sets (ESPIRE not included) from both companies – including the improved Scimitar turret (CK3522) – plus a completely new PE Plasan set designed by Tetra Model Works, additional SMM resin fittings, plus parts from the AFV Club Scimitar kit – all in one box.



with

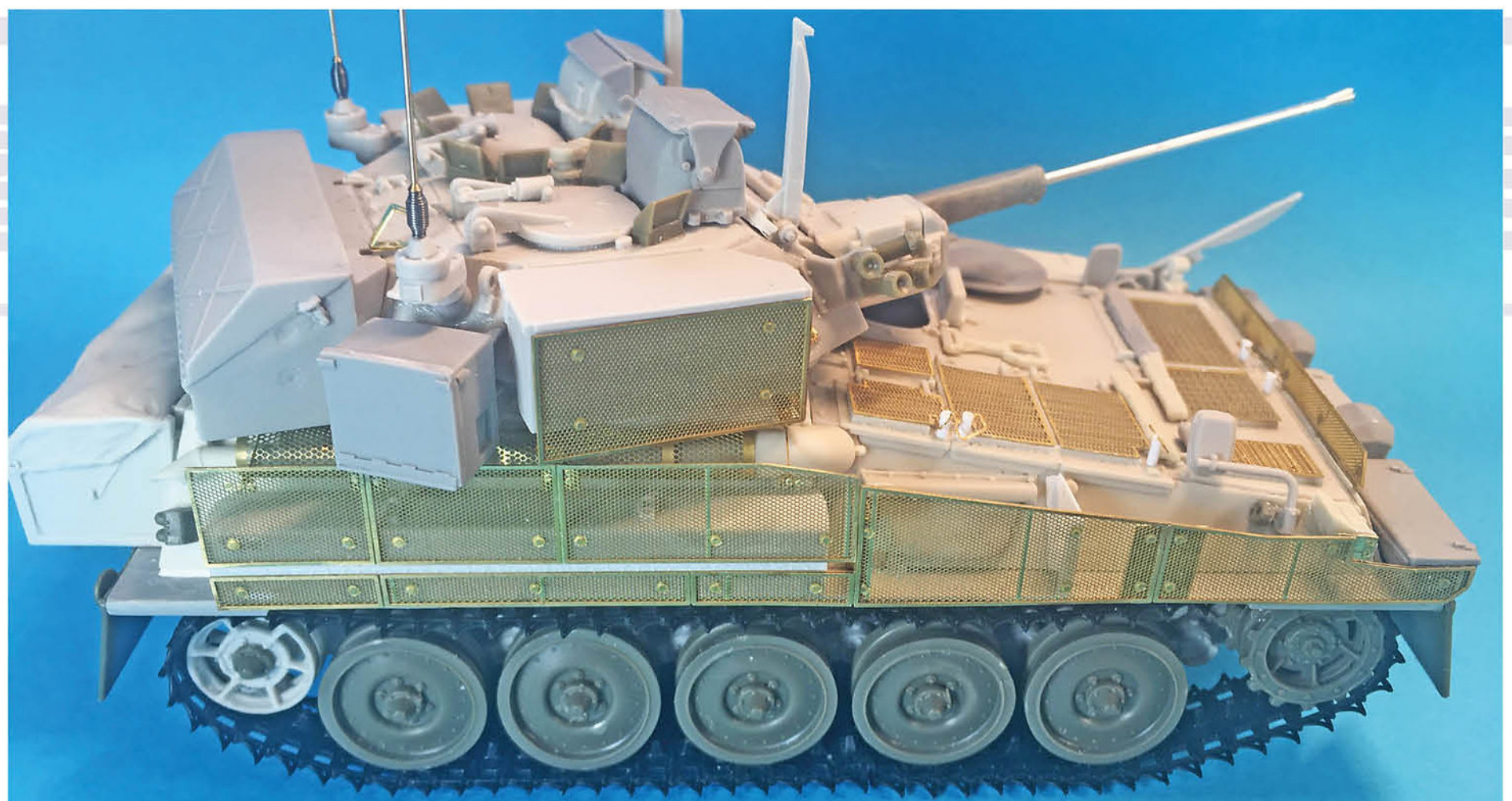
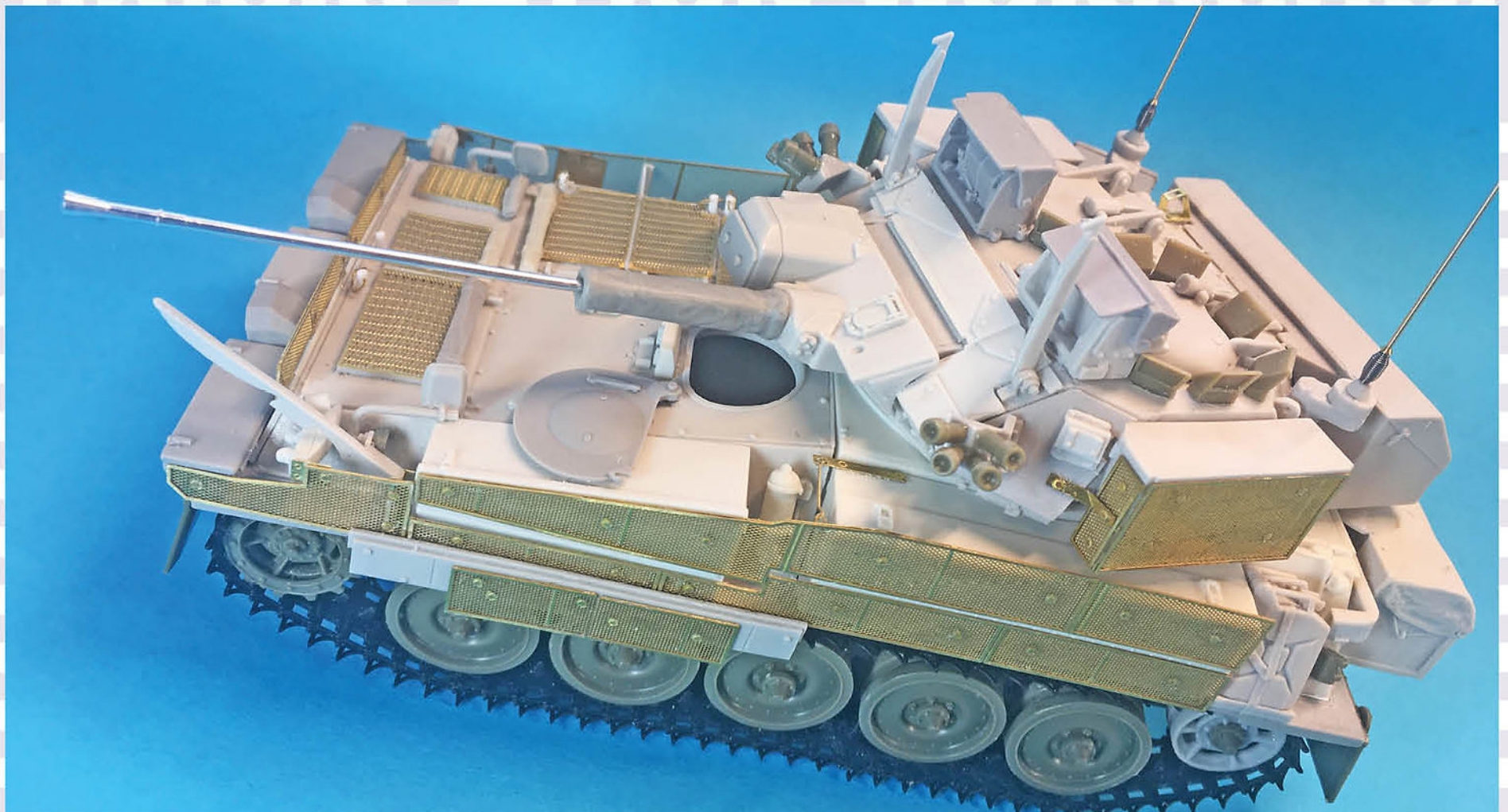

Parts list (from **SMM3529** Underbelly Mine Protection)

- |                                    |                                  |
|------------------------------------|----------------------------------|
| <b>1</b> Suspension arm left (x3)  | <b>7</b> Nose plate              |
| <b>2</b> Suspension arm right (x3) | <b>8</b> Idler arm left          |
| <b>3</b> Suspension arm left       | <b>9</b> Idler arm right         |
| <b>4</b> Suspension arm left       | <b>10</b> Main hull tub          |
| <b>5</b> Suspension arm right      | <b>11</b> Belly plate            |
| <b>6</b> Suspension arm right      | <b>12</b> Damper arms left (x2)  |
|                                    | <b>13</b> Damper arms right (x2) |

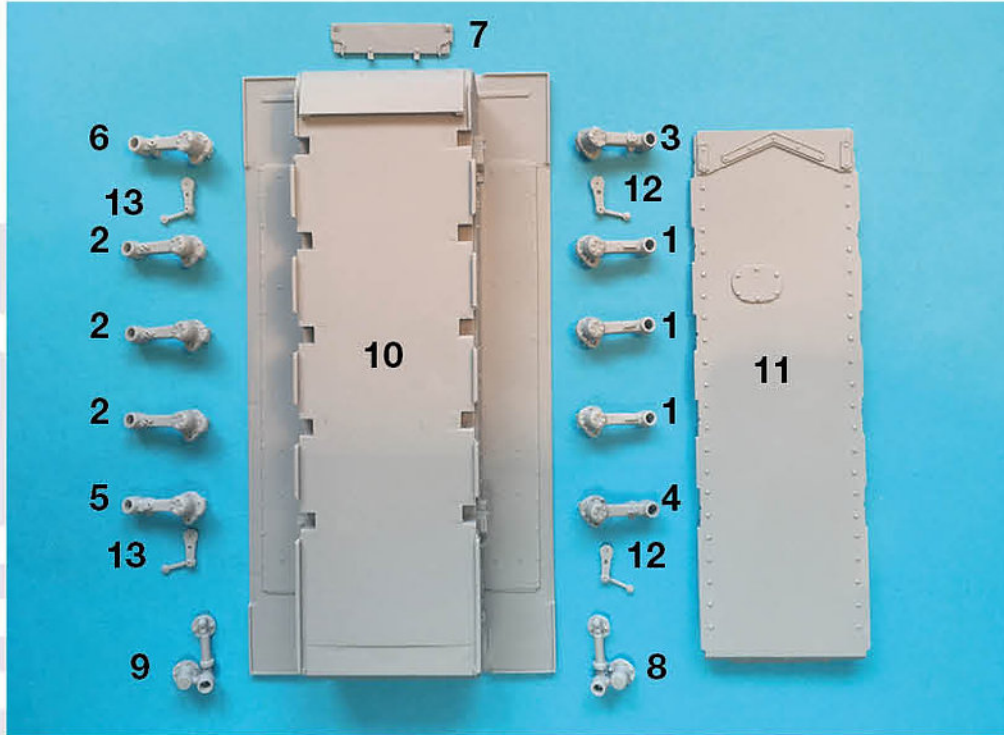

The suspension arms are numbered near the wheel hub to identify them. These will be hidden by the wheels (or can be removed, of course).

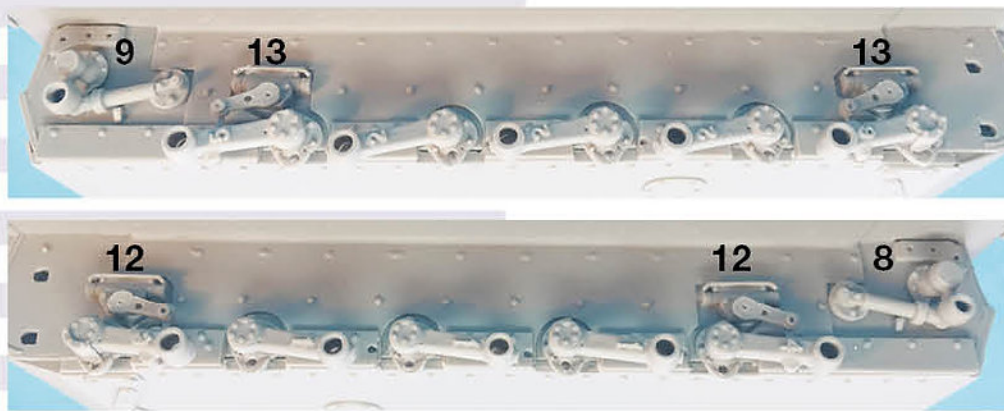

Parts list (from **CK3518** BGTI Sights)

- |                                  |                        |
|----------------------------------|------------------------|
| <b>1</b> Gunner's sight          | <b>5</b> Receiver base |
| <b>2</b> Gunner's sight cover    | <b>6</b> GPS receiver  |
| <b>3</b> Commander's sight       |                        |
| <b>4</b> Commander's sight cover |                        |

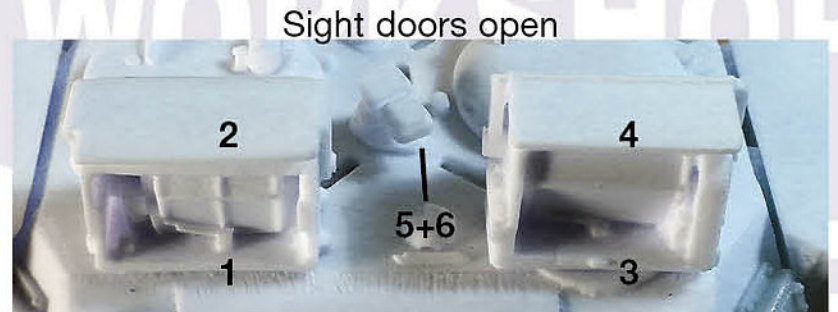
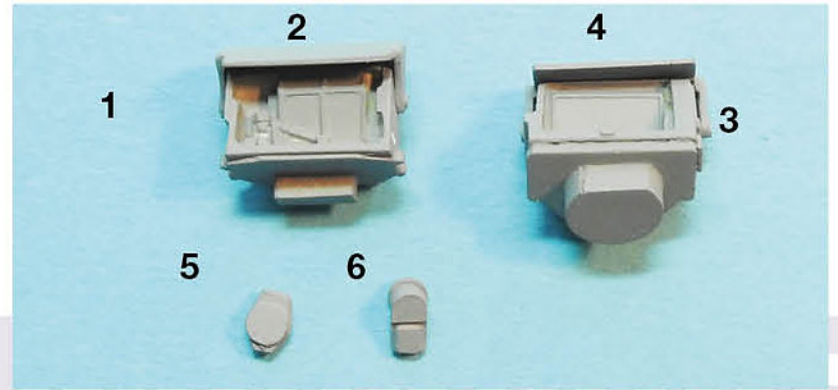

**ESPIRE option**  
 Instead of BGTI sights, ESPIRE sights, etc. could be substituted from set **CK3516** (not included).

Parts list (from **CK3522** Replacement Turret)

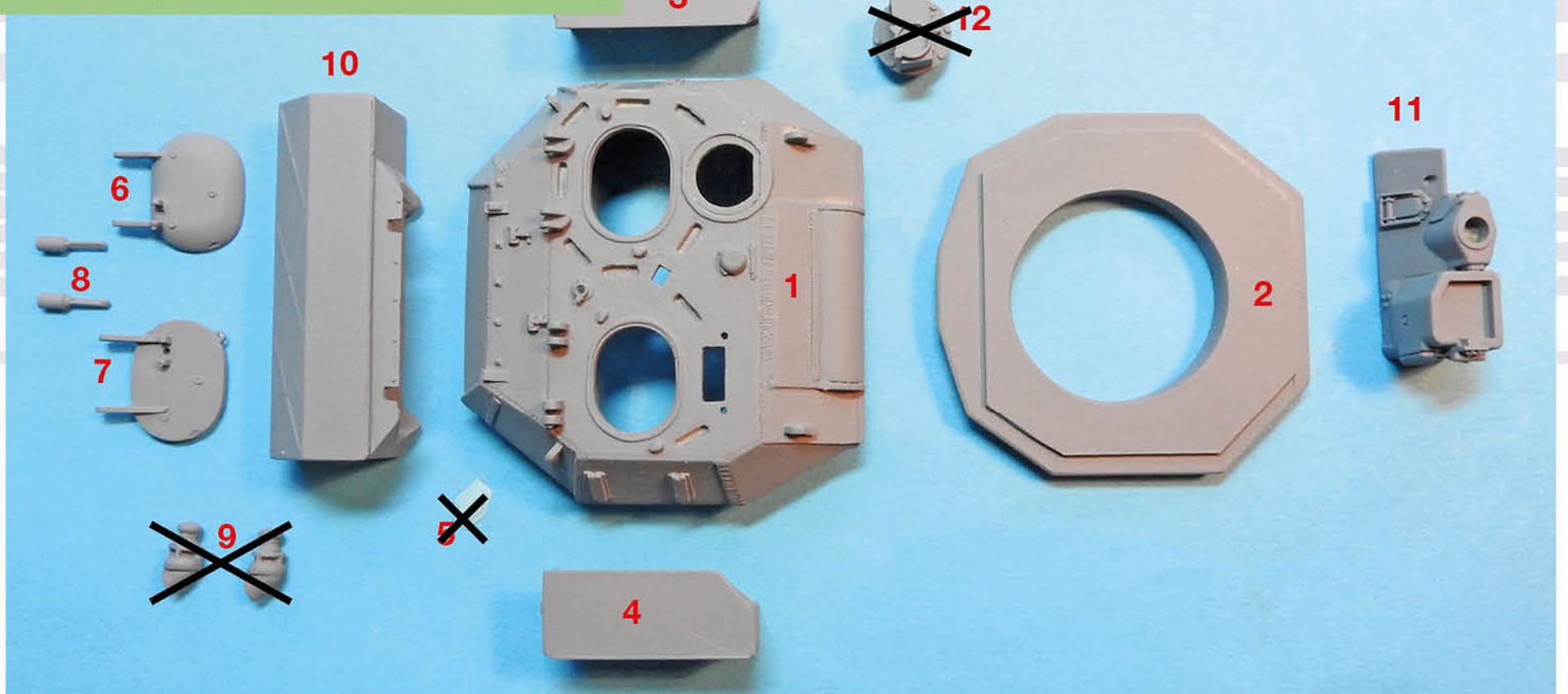

- |                                    |  |  |
|------------------------------------|--|--|
| <b>1</b> Turret shell              | <b>6</b> Commander's hatch                     | <b>11</b> Scimitar mantlet                             |
| <b>2</b> Turret base               | <b>7</b> Gunner's hatch                        | <del><b>12</b> Commander's sight with OTIS mount</del> |
| <b>3</b> Turret box left           | <b>8</b> Hatch dampers (x2)                    |  |
| <b>4</b> Turret box right          | <del><b>9</b> Clansman aerial bases (x2)</del> |  |
| <del><b>5</b> Electrical cap</del> | <b>10</b> Turret box rear                      |  |

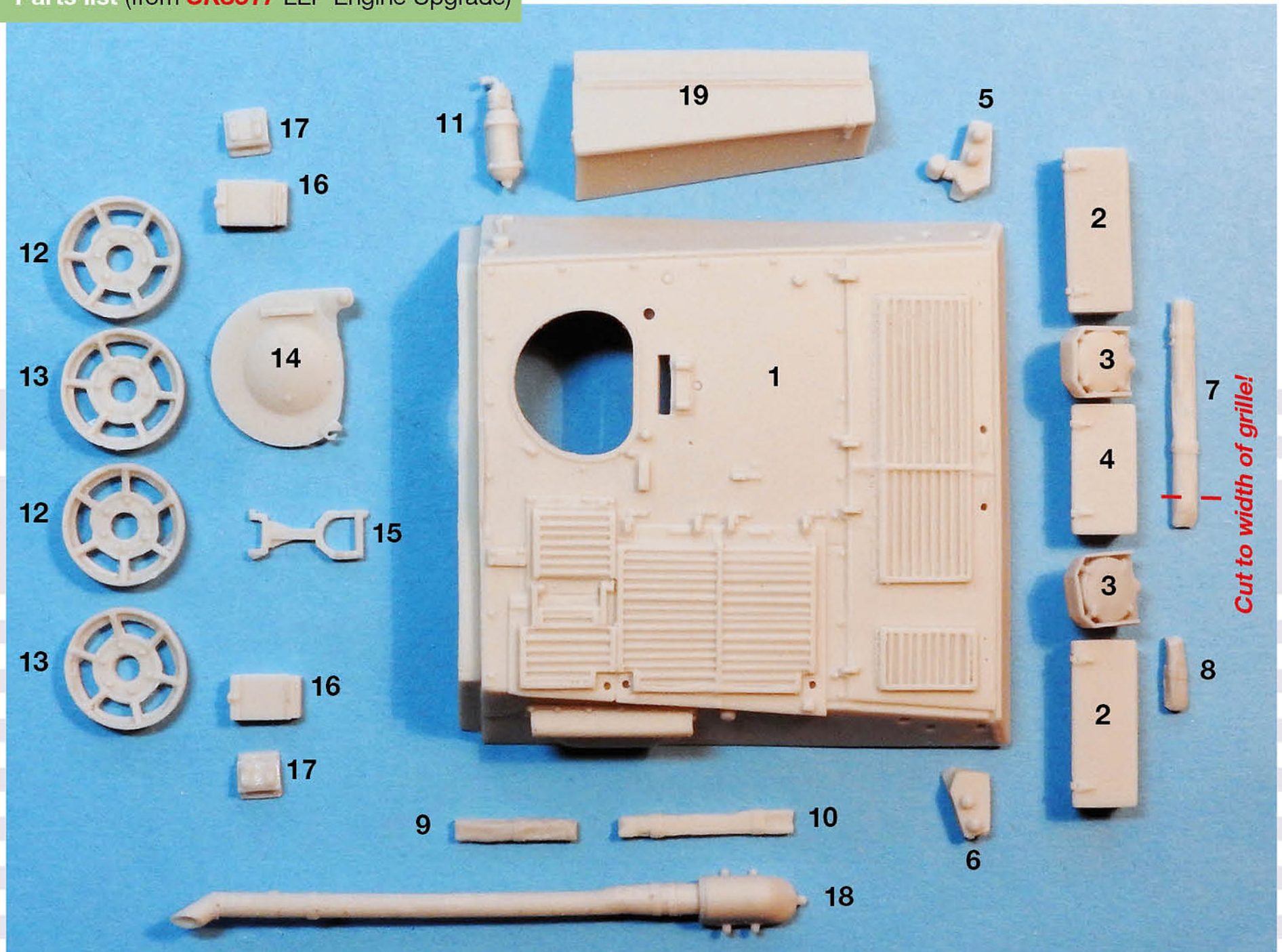
Parts list (from **CK3517** LEP Engine Upgrade)

- 1** Scimitar LEP forward hull
- 2** Front stowage bins (long) (2 supplied)
- 3** Cowled headlights (2 supplied)
- 4** Front stowage bins (short)
- 5** Horizontal side-lights left with warning light 'pod'
- 6** Horizontal side-lights right
- 7** Engine deck grill weather cover 1
- 8** Engine deck grill weather cover 2
- 9** Engine deck grill weather cover 3
- 10** Engine deck grill weather cover 4
- 11** Halon fire extinguisher

- 12** 6 Spoke idler – outer
- 13** 6 Spoke idler – inner
- 14** Driver's hatch
- 15** Gun barrel travel clamp
- 16** Smoke grenade boxes (2 supplied)
- 17** Smoke grenade box mounts (2 supplied)
- 18** LEP exhaust pipe
- 19** Hull box left side

**PE** Photo-etch grille screens and engine cover loops

**Some warping may be evident,**  
so use hot water to straighten parts  
as necessary.

**Do not bend without heating.**

**Damage may occur on parts with thicker  
casting tabs.**

When removing the casting tabs,  
cut them off instead of snapping them off.



--- Bend as indicated.  
See opposite page also.

Parts list (from **CK3519** Bowman Radio)

- |                                   |                                    |
|-----------------------------------|------------------------------------|
| <b>1</b> Bowman radio box         | <b>5</b> Brass antenna masts (x2)  |
| <b>2</b> Box lid                  | <b>6</b> Spring bases (x2)         |
| <b>3</b> Junction box             | <b>7</b> Brass mounting posts (x2) |
| <b>4</b> Bowman aerial bases (x2) |                                    |

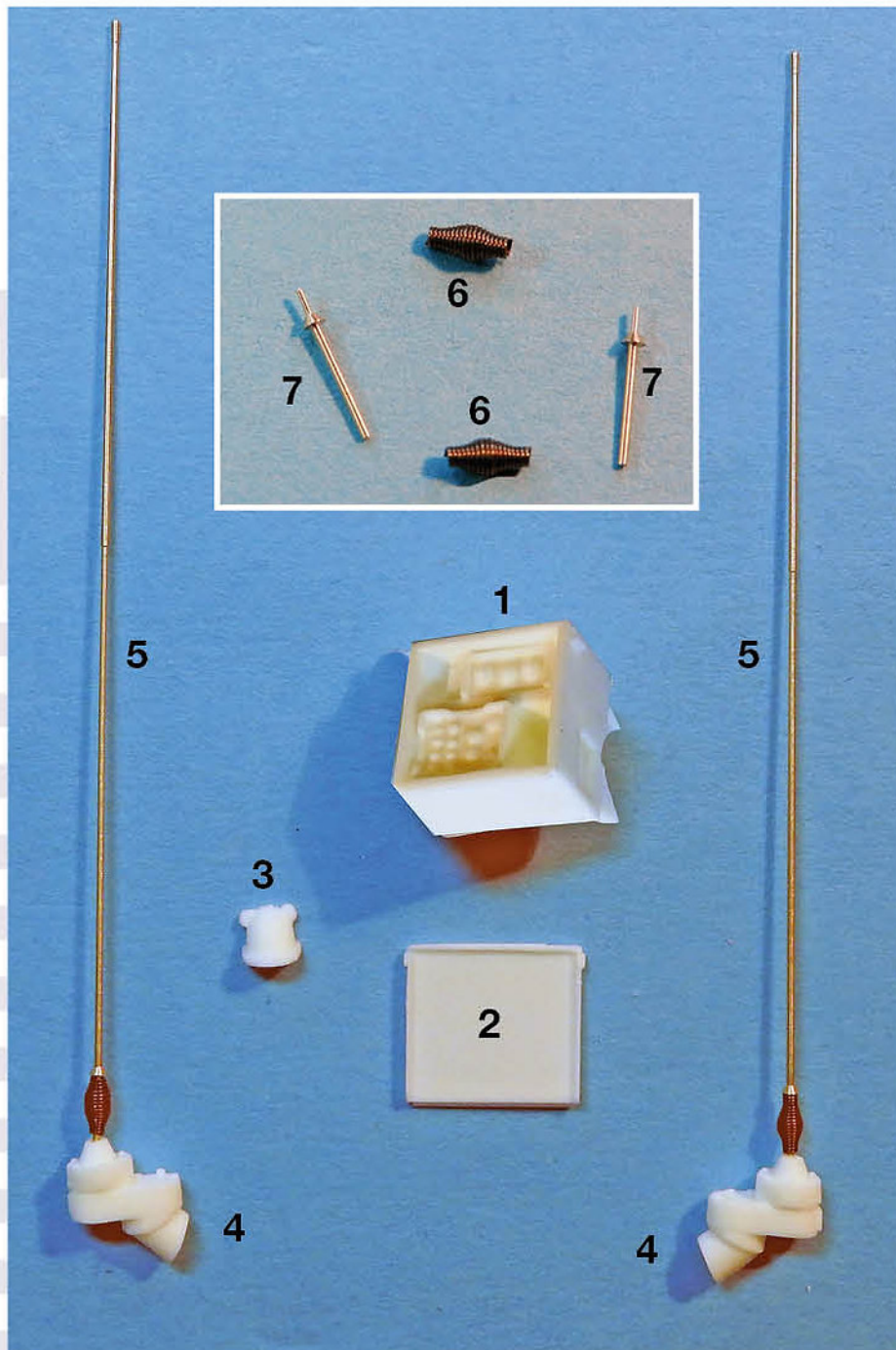

## New parts (below)

including *optional parts*

- |            |  |
|------------|--|
| <b>N1</b>  | Rear hull  |
| <b>N2</b>  | Left side hull stowage box                               |
| <b>N3</b>  | Right side hull stowage box                              |
| <b>N4</b>  | Jerrican   |
| <b>N5</b>  | NBC intake   |
| <b>N6</b>  | Hull Pusan mount plate                                   |
| <b>N7</b>  | Rear hull box  |
| <b>N8</b>  | Smoke launcher mounts – left <b>L</b> and right <b>R</b> |
| <b>N9</b>  | Barrel slider ( <i>optional</i> )                        |
| <b>N10</b> | Covered barrel slider ( <i>optional</i> )                |
| <b>N11</b> | Front turret appliqué armour                             |
| <b>N12</b> | Turret appliqué armour lower right                       |
| <b>N13</b> | Mirror left  |
| <b>N14</b> | Mirror right   |
| <b>N15</b> | Night sight appliqué armour                              |
| <b>N16</b> | Tow pintle   |
| <b>N17</b> | Turret appliqué armour upper left                        |
| <b>N18</b> | Turret cutter bolts ( <i>optional</i> ) (x2)             |
| <b>N19</b> | Tail light   |
| <b>N20</b> | Turret appliqué armour upper right                       |
| <b>N21</b> | Turret wire cutter right ( <i>optional</i> )             |
| <b>N22</b> | Turret wire cutter left ( <i>optional</i> )              |
| <b>N23</b> | Hull front appliqué armour                               |
| <b>N24</b> | Left lower hull appliqué armour ( <i>optional</i> )      |
| <b>N25</b> | Fire extinguishers                                       |
| <b>N26</b> | Turret night sight door                                  |
| <b>N27</b> | Hull-mounted wire cutter ( <i>optional</i> )             |
| <b>N28</b> | Driver's periscope                                       |

Parts from **AFV Club**

AFV Club parts are green plastic

**Complete sprue C** (x2) – wheels, periscopes, smoke launchers, mud flaps, etc.  
 Turned aluminium barrel  
 Vinyl tracks  
 PE fret with exhaust screen, etc.

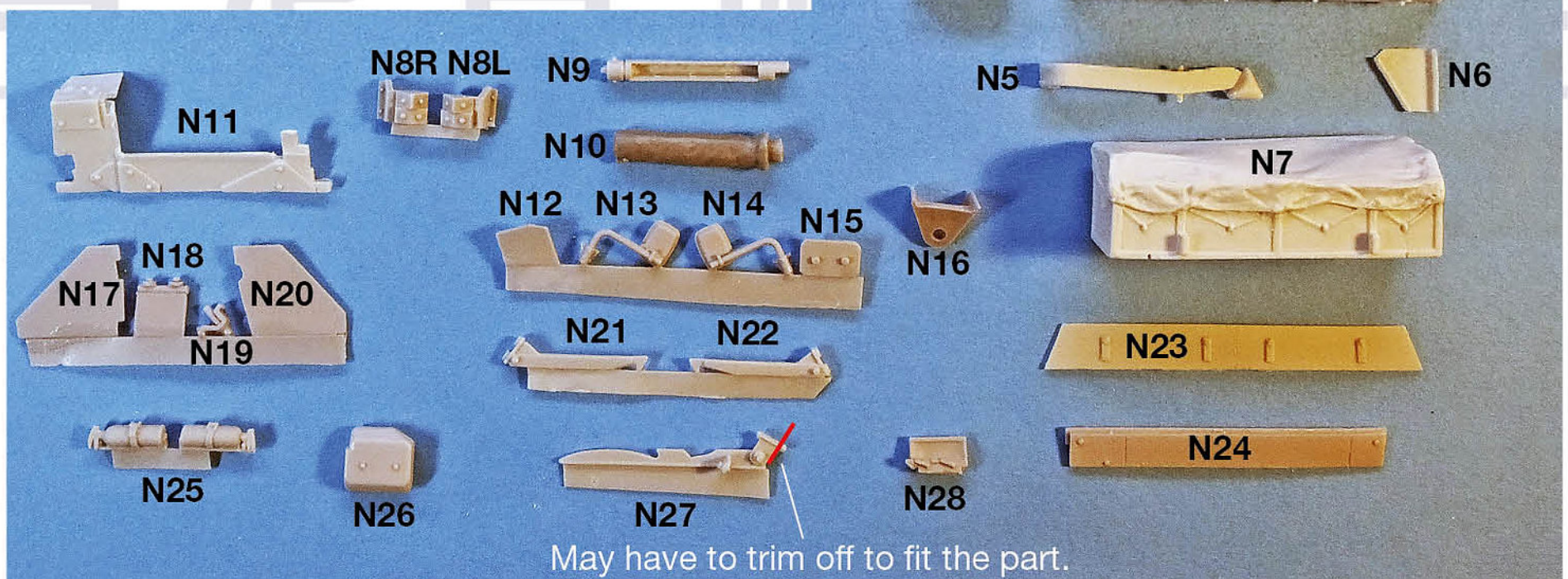
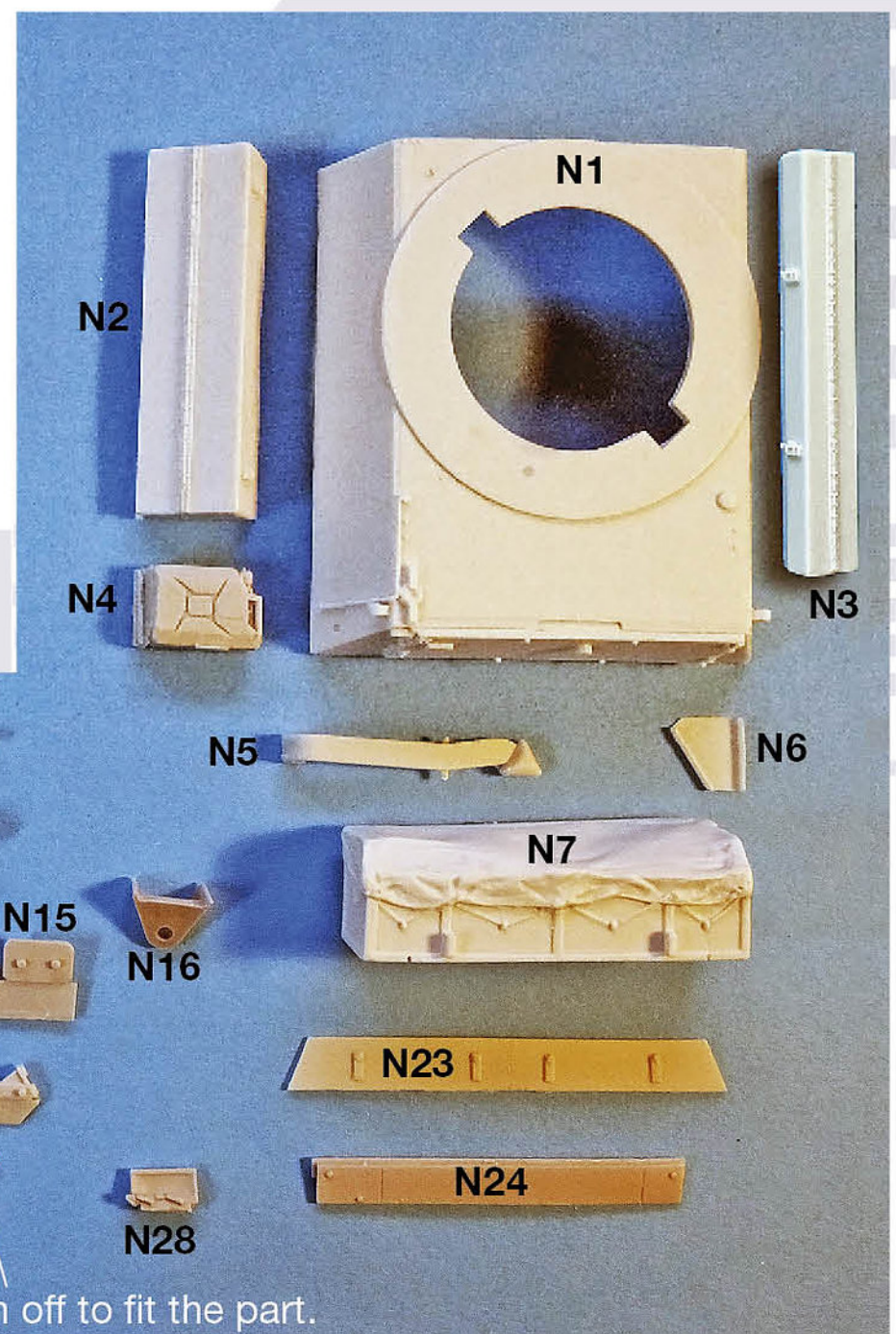

May have to trim off to fit the part.

**Notes**

- 1 Start with the lower hull and build up the suspension.
- 2 *AFV Club* vinyl tracks are included in the kit. I know they are not the most popular. However, they ARE usable. Soak them for a couple of minutes in very hot tap water, stretch them **slightly** and they are fine. Drill a couple of holes in the side of the hull and put pins in to get the sag. Not ideal but you can't really see them.

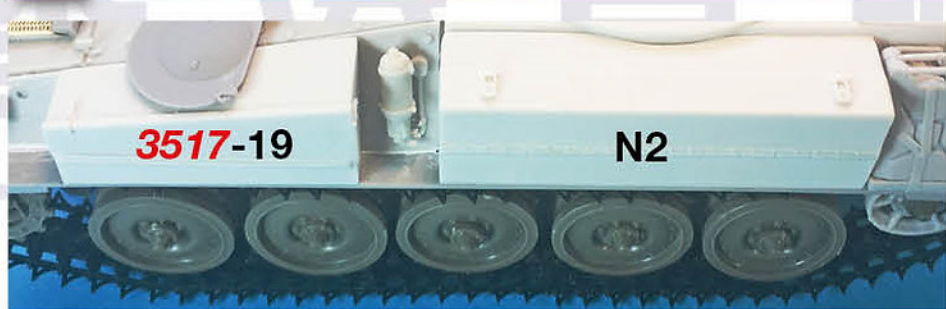
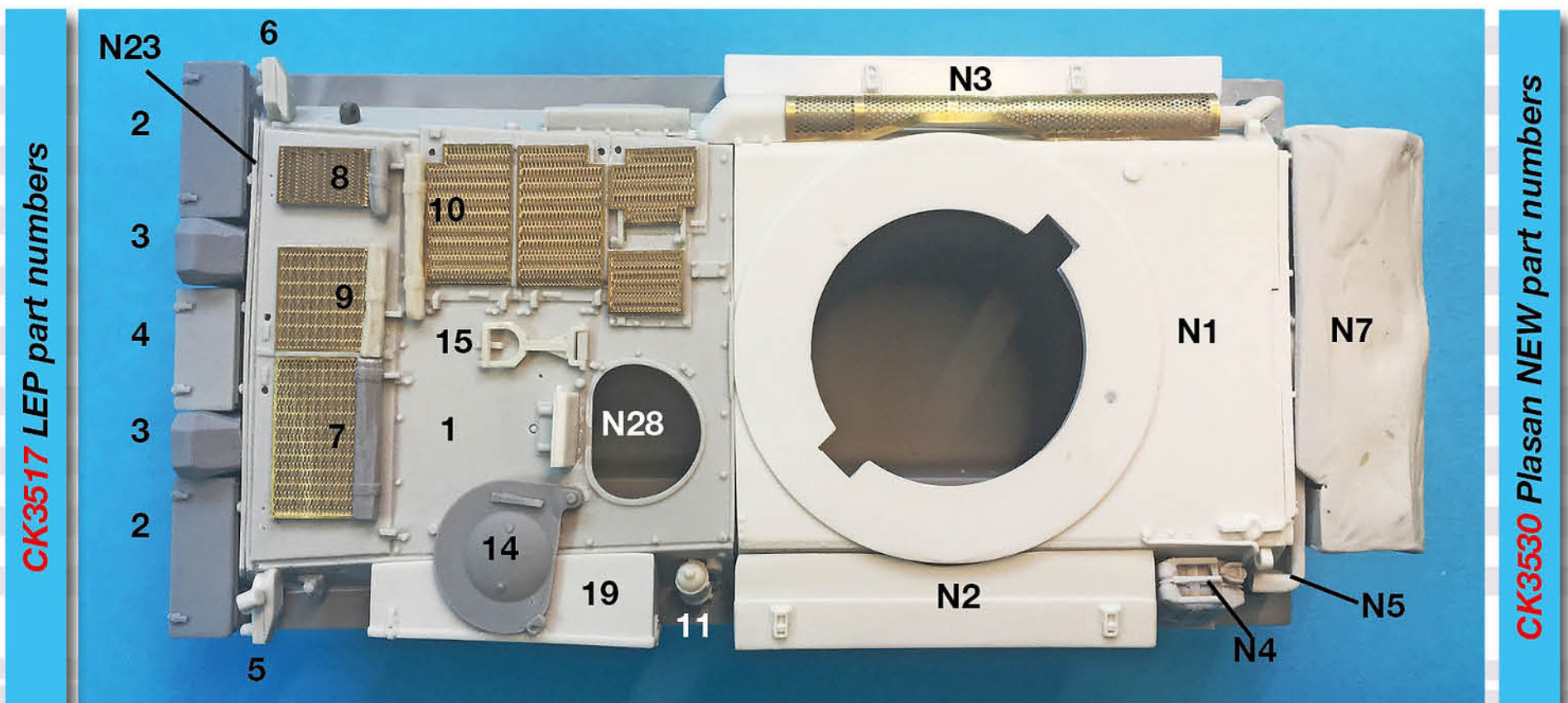

Make sure the three side hull boxes are **FLUSH** with the outside edge of the trackguard. If they stick out, the Plasan will **NOT** be level.

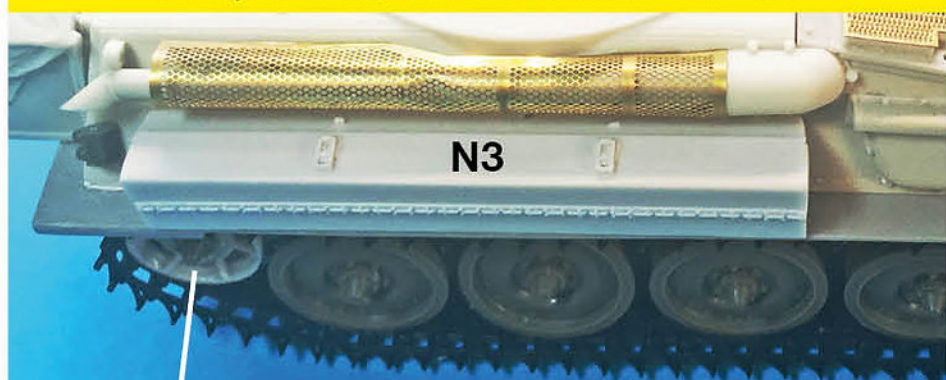

3517-12 and 13 **AFV Club wheels and hubs**

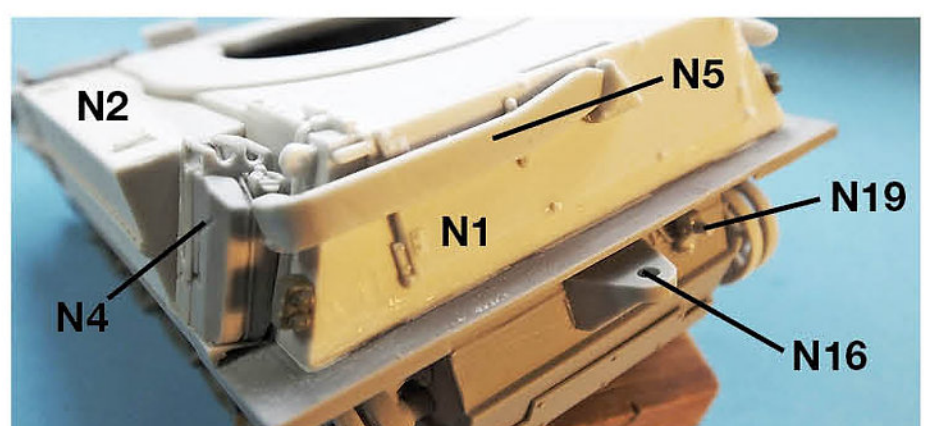
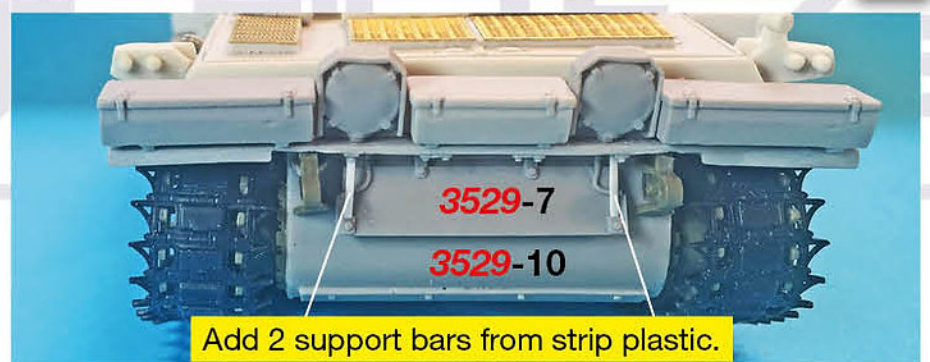

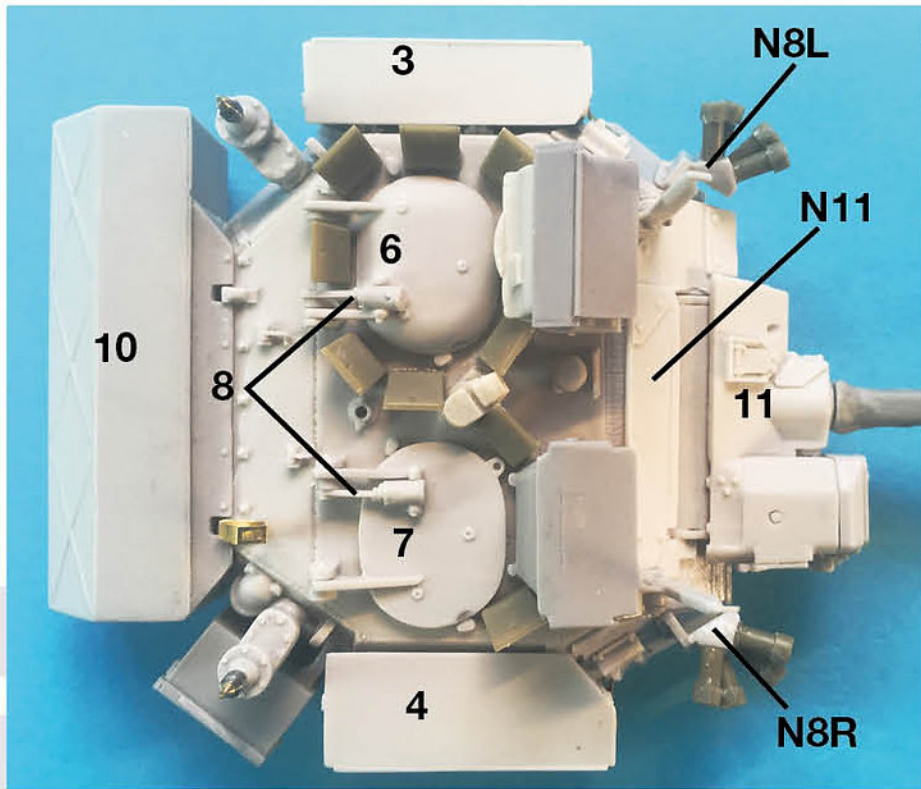

**CK3522 Replacement Turret part numbers**

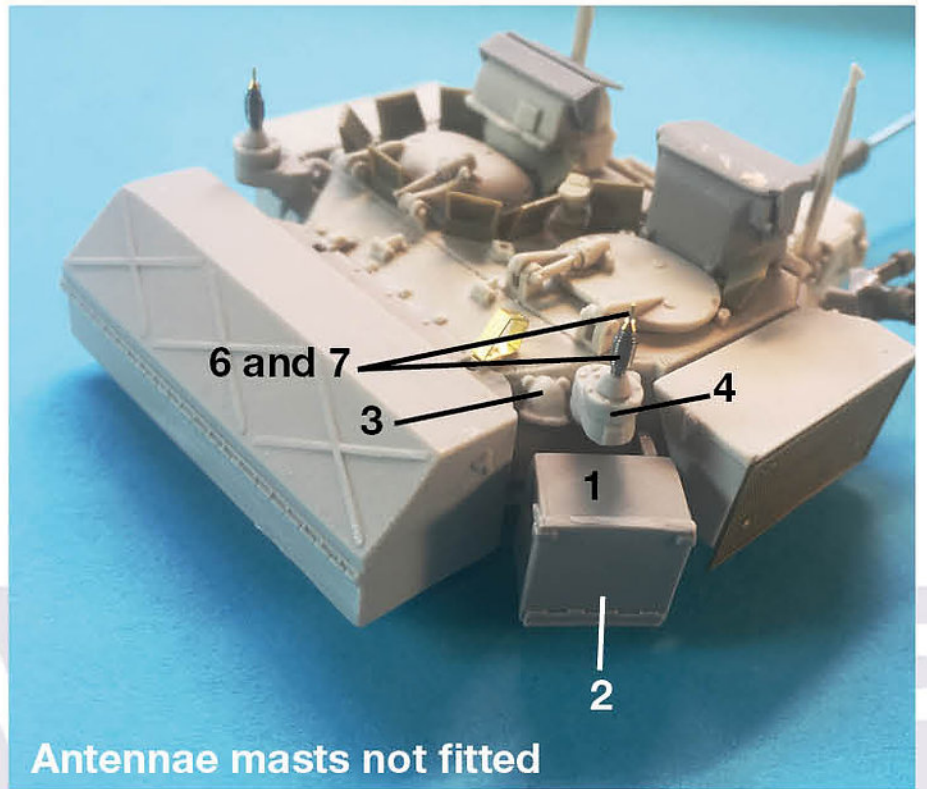

Antennae masts not fitted

**CK3519 Bowman part numbers**

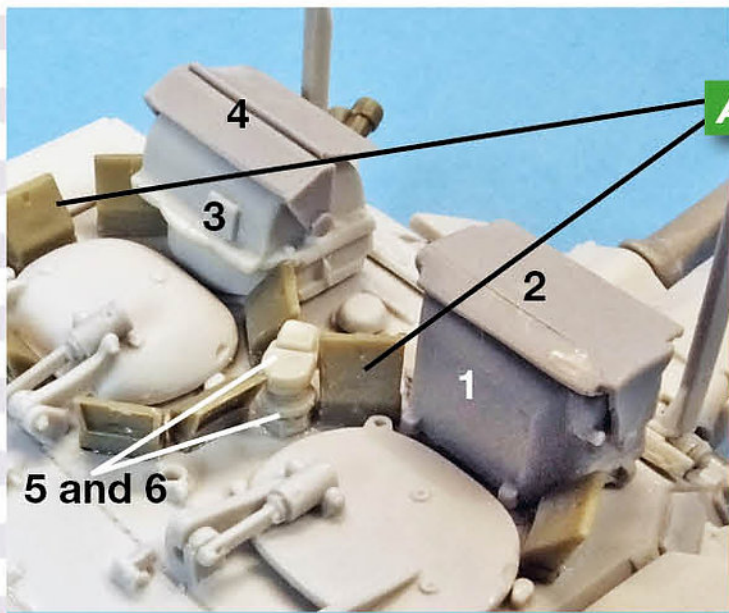

**CK3518 BGTI part numbers**

**AFV Club periscopes**

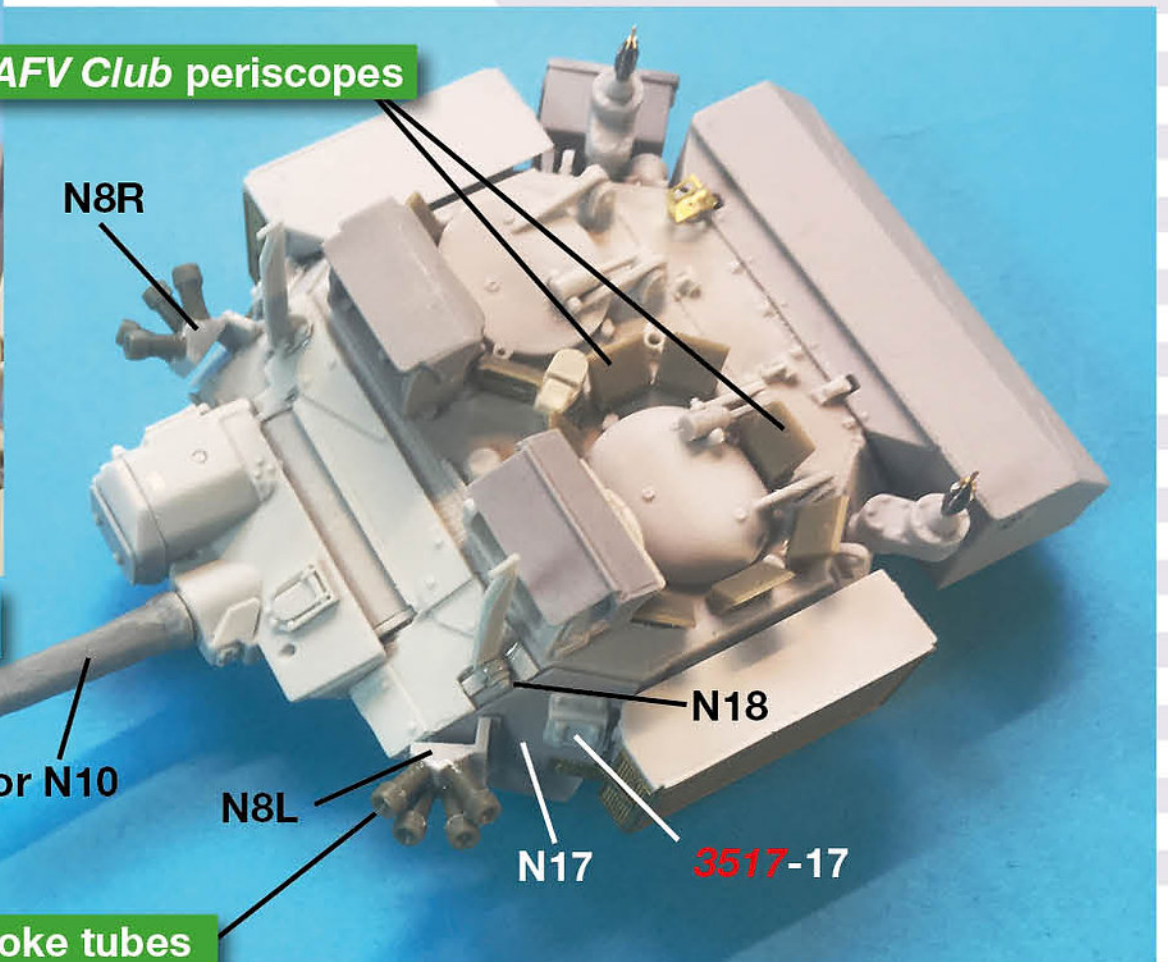

**AFV Club barrel**

**AFV Club smoke tubes**

**N18/N21/N22 (optional)**

N21/22 – remove the bolts under the baseplate so the lifting eye holes line up.

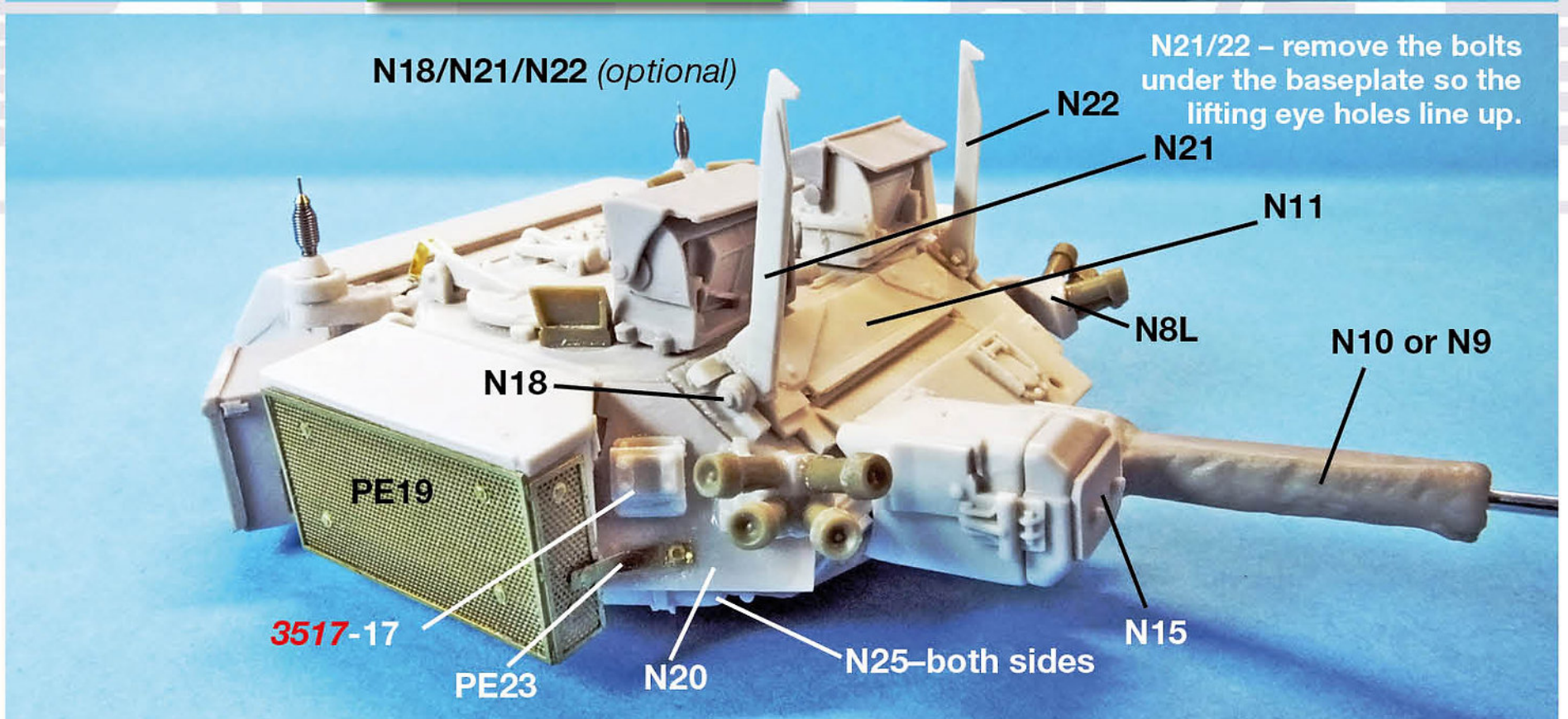

Fold the frames onto the perforated plates BEFORE removing them from the fret. It keeps them flat and avoids confusion.

PE Parts

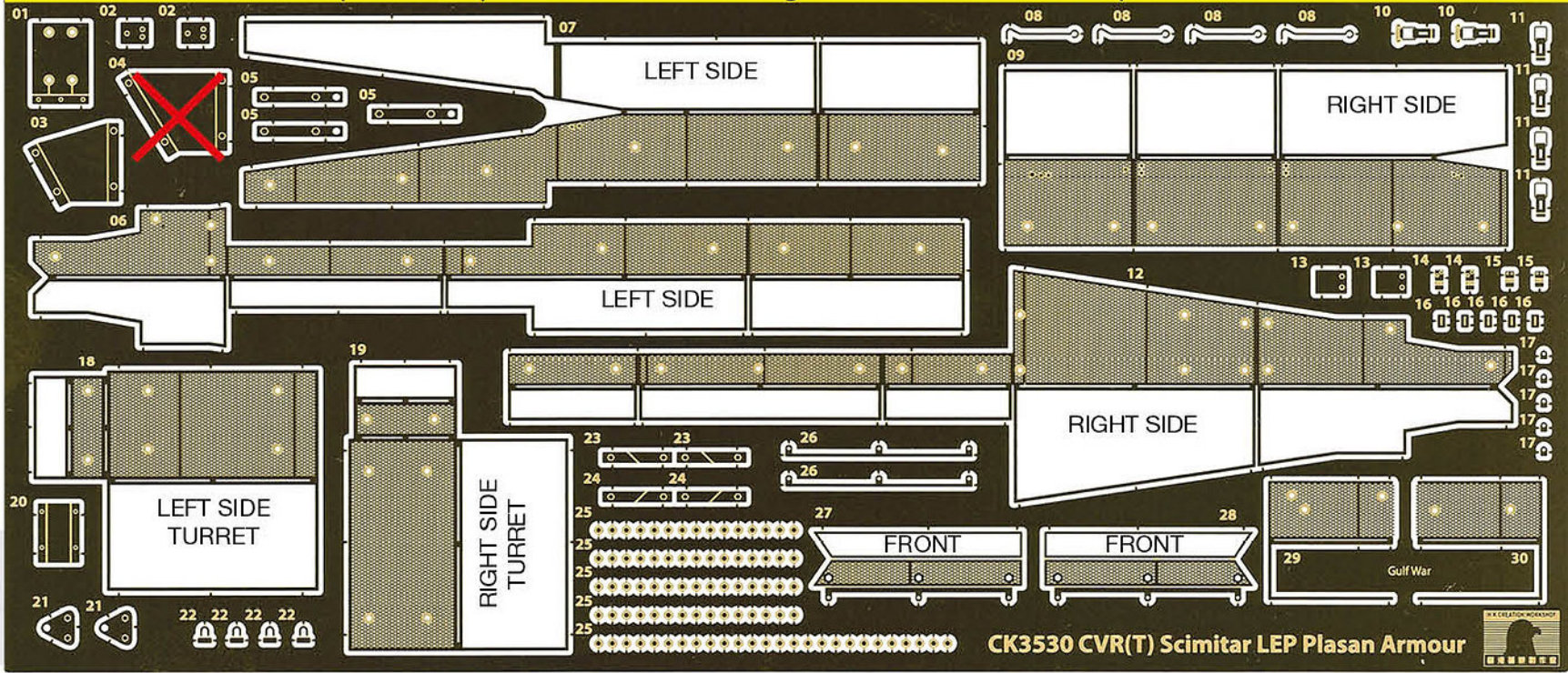

Designed by Tetra Model Works

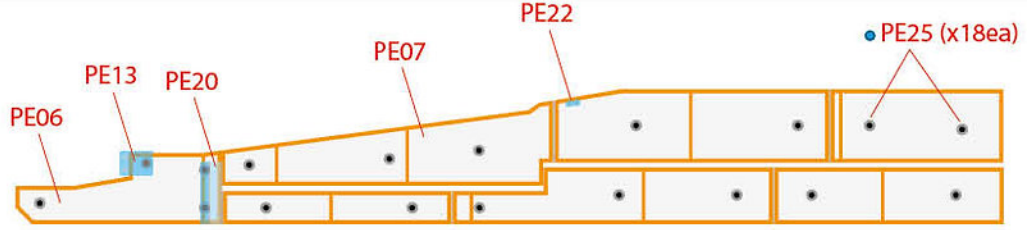
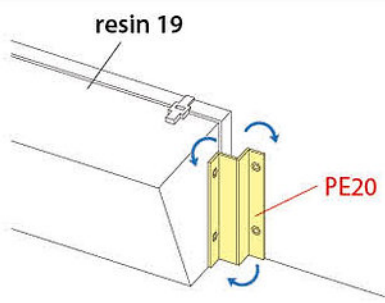

PE04 replaced by hull Plasan mount plate – resin part N6 (new)

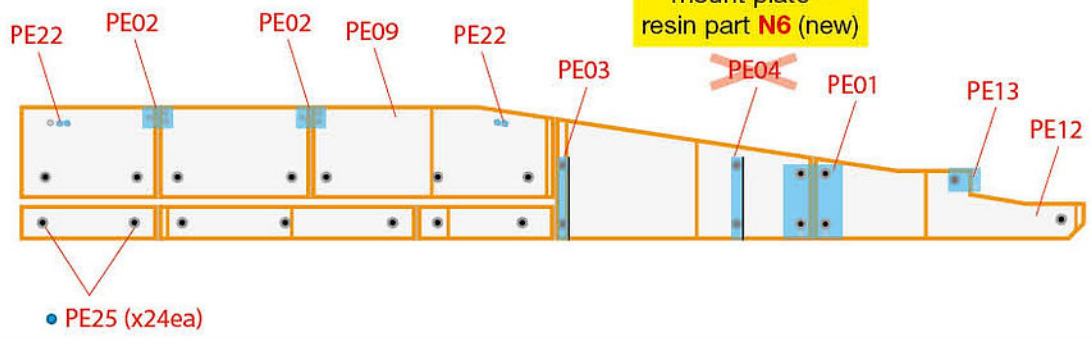
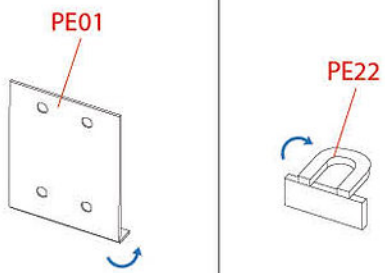

As a bonus, included are six sets of stowage box latches

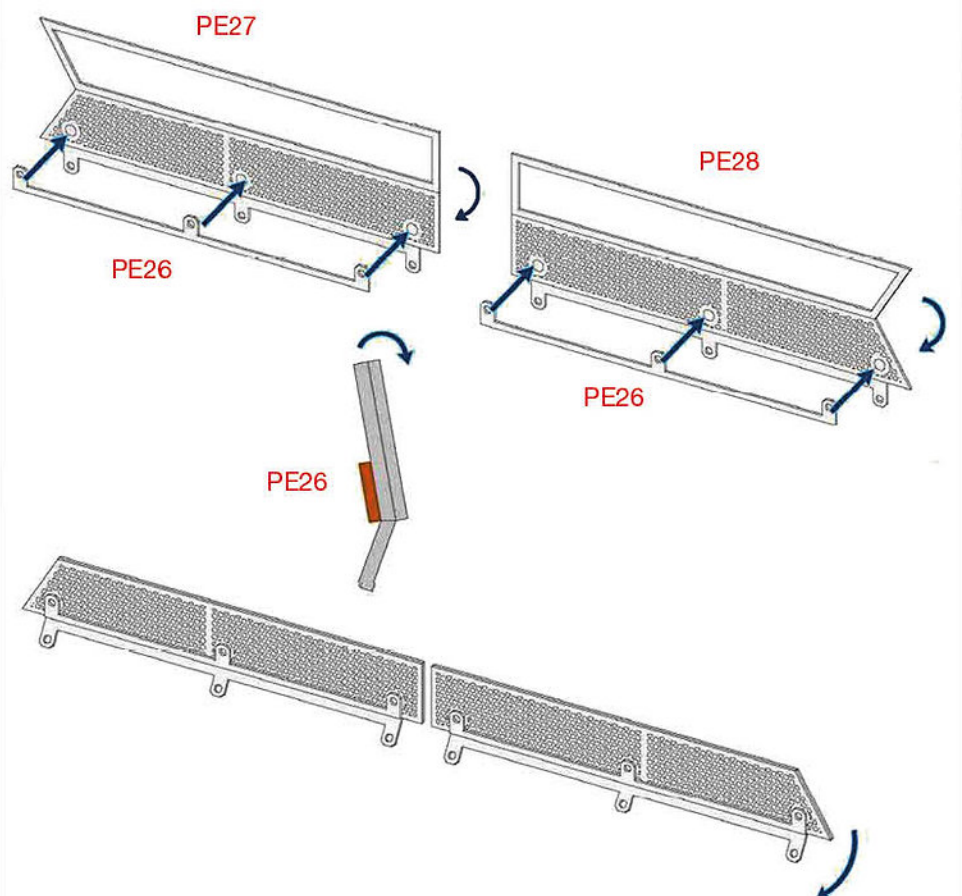
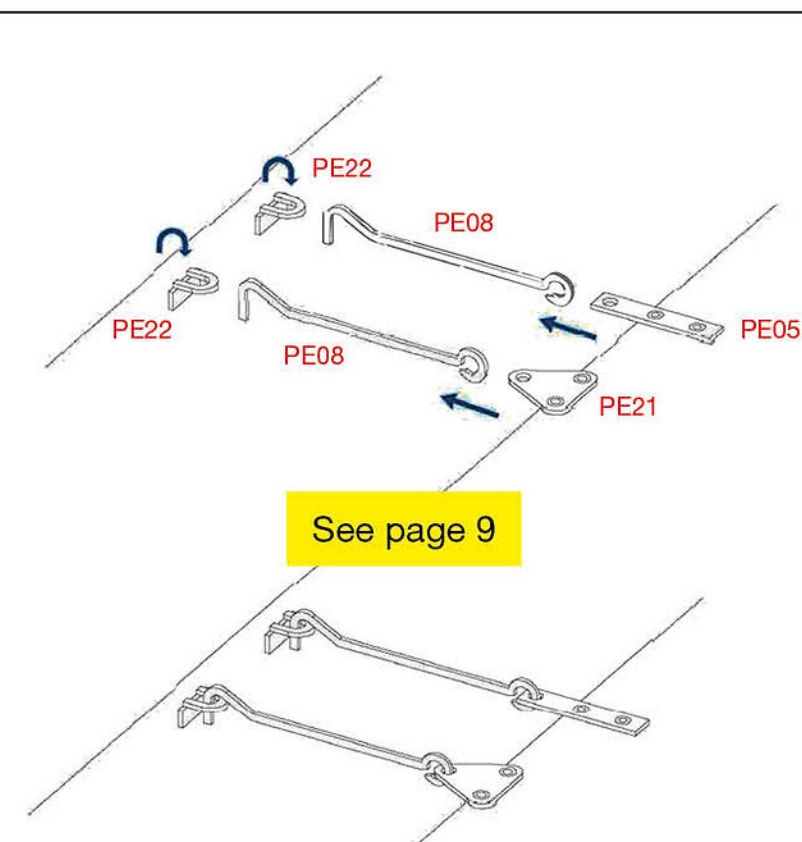
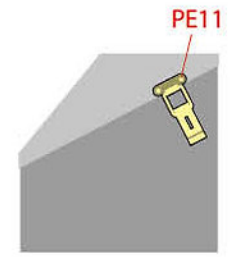
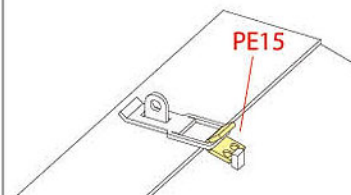
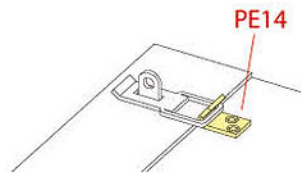
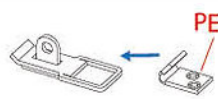
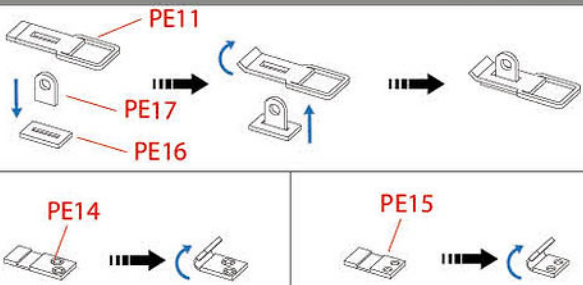

**Notes** (continued)

**3** Below are the **REAR SIDES** of the Plasan showing positioning of joining plates and mounting eyes (3xPE22).

**4** Best way to attach these is either by using gloss varnish or white glue, and fixing with THIN superglue if you feel the need. Use a cocktail stick with *Blutac* on one end to pick up and position.

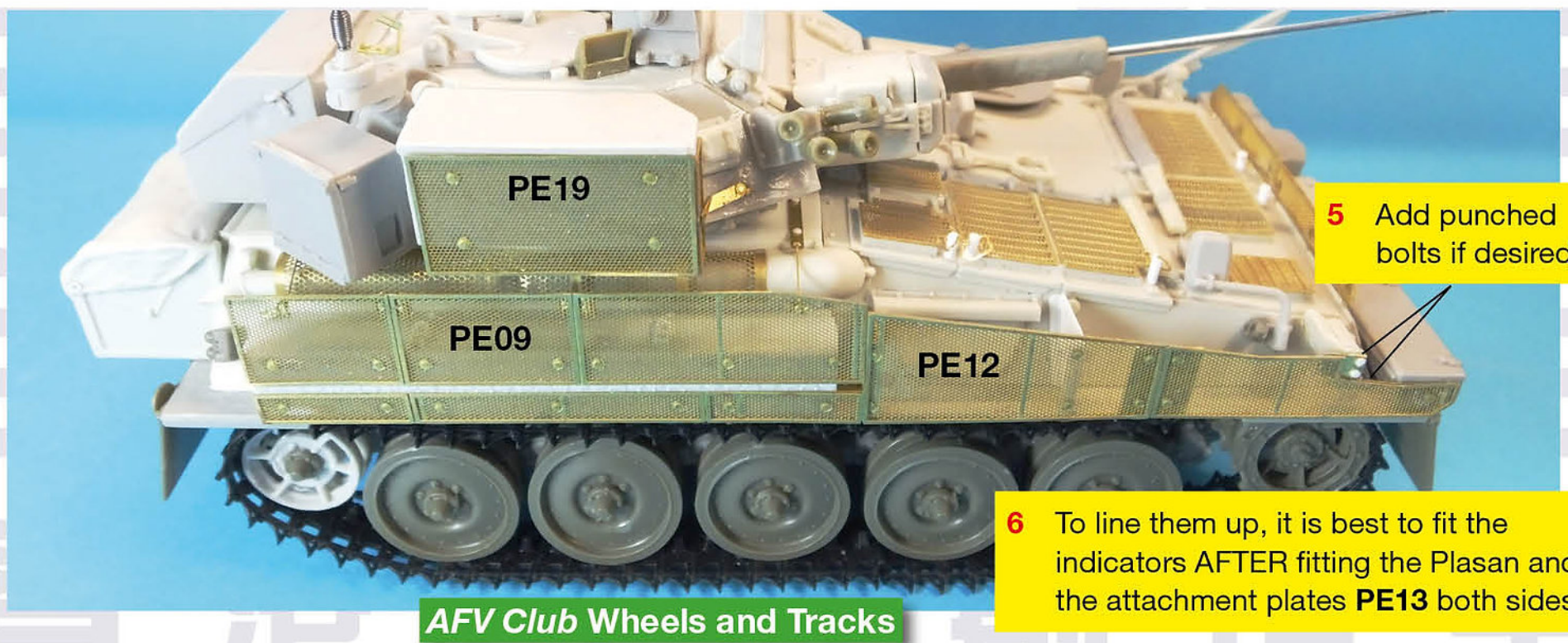
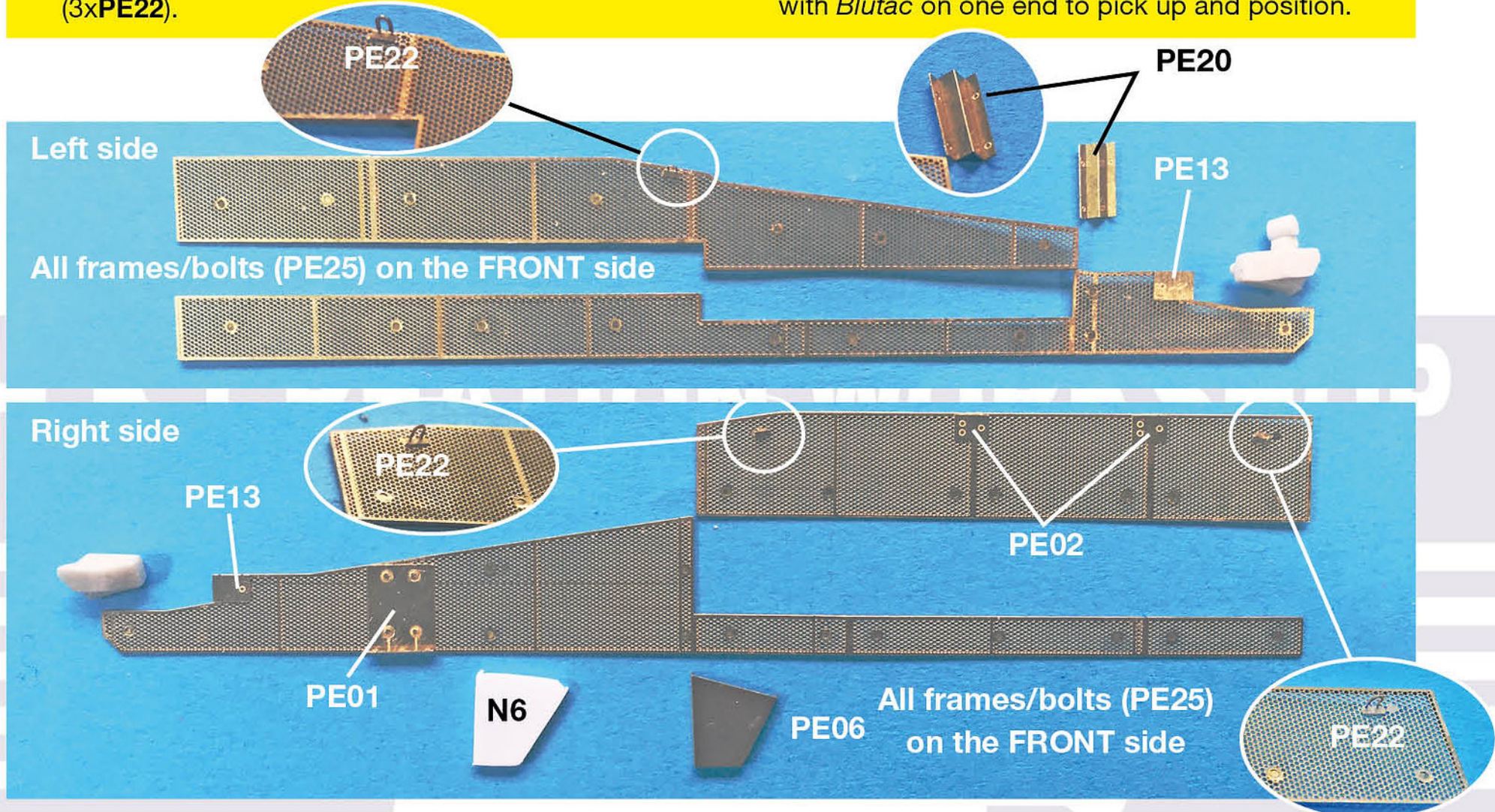

**5** Add punched bolts if desired.

**6** To line them up, it is best to fit the indicators **AFTER** fitting the Plasan and the attachment plates **PE13** both sides.



**7** This hull plate (**N24** and **PE29/30**) is optional as it was rarely fitted. The Plasan panels also appeared in numerous different positions on the backing plate.



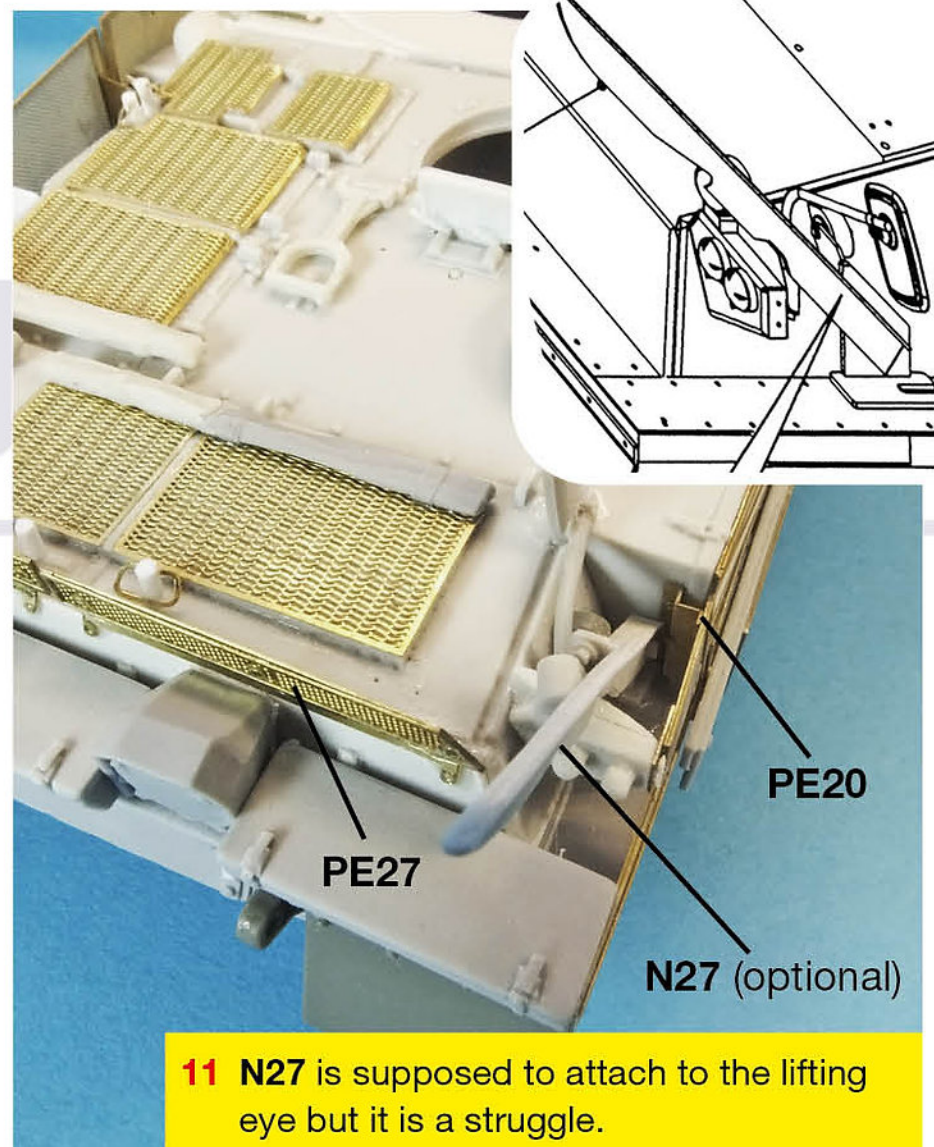
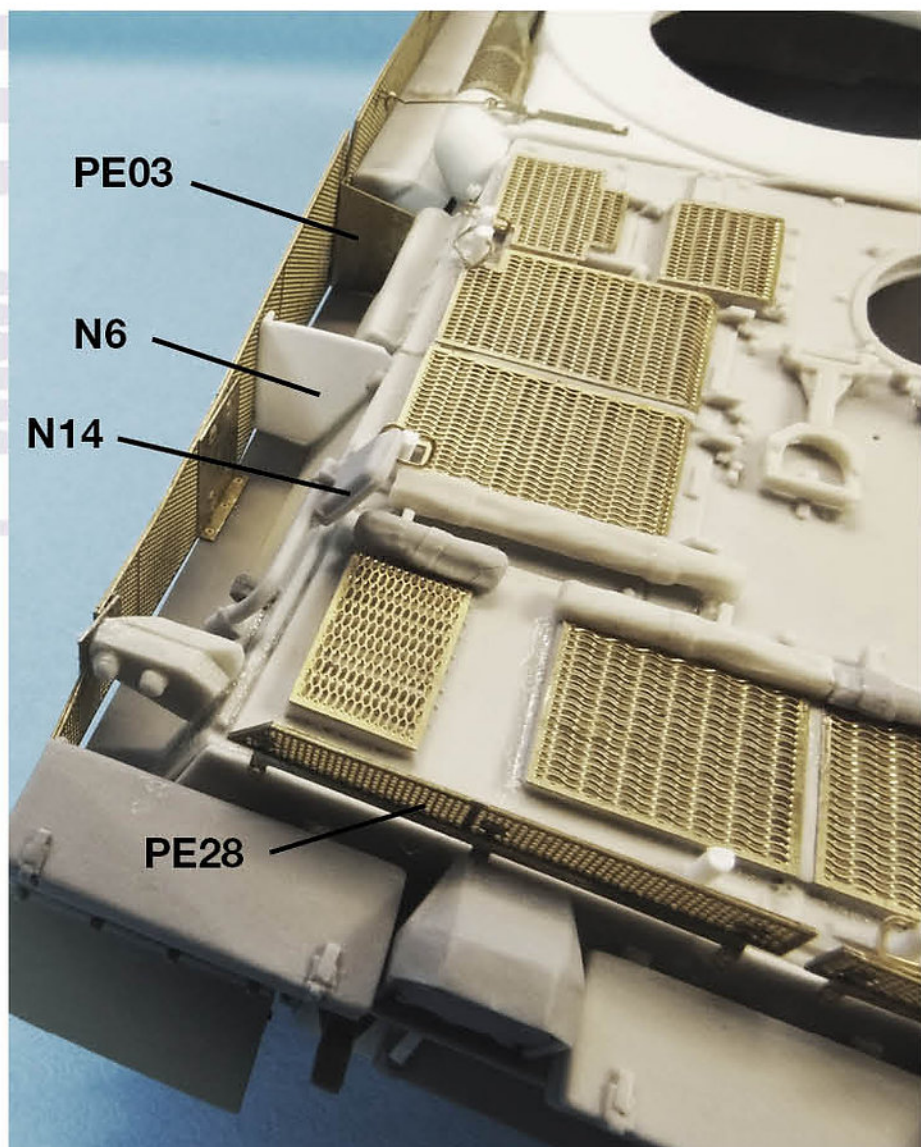
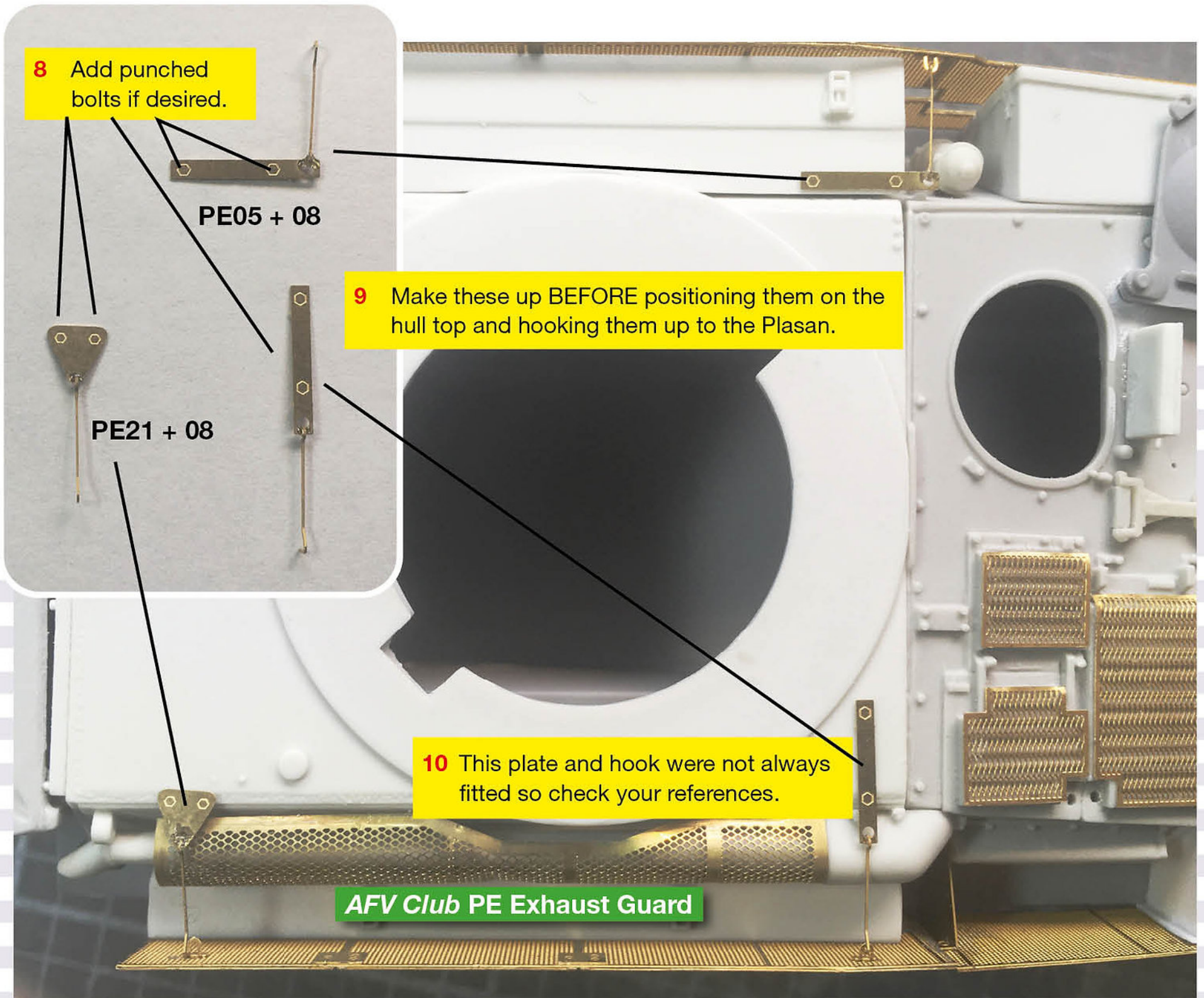

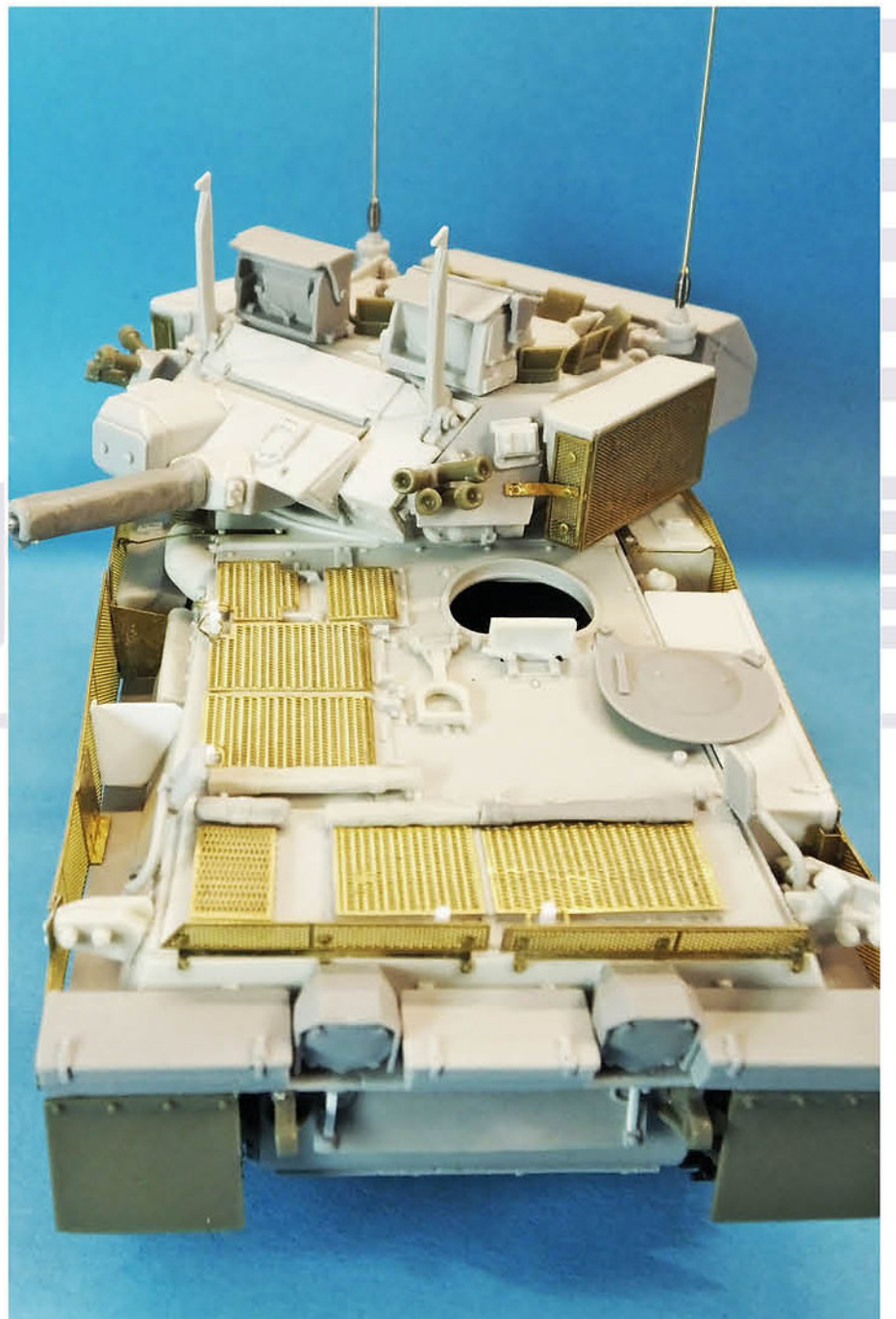
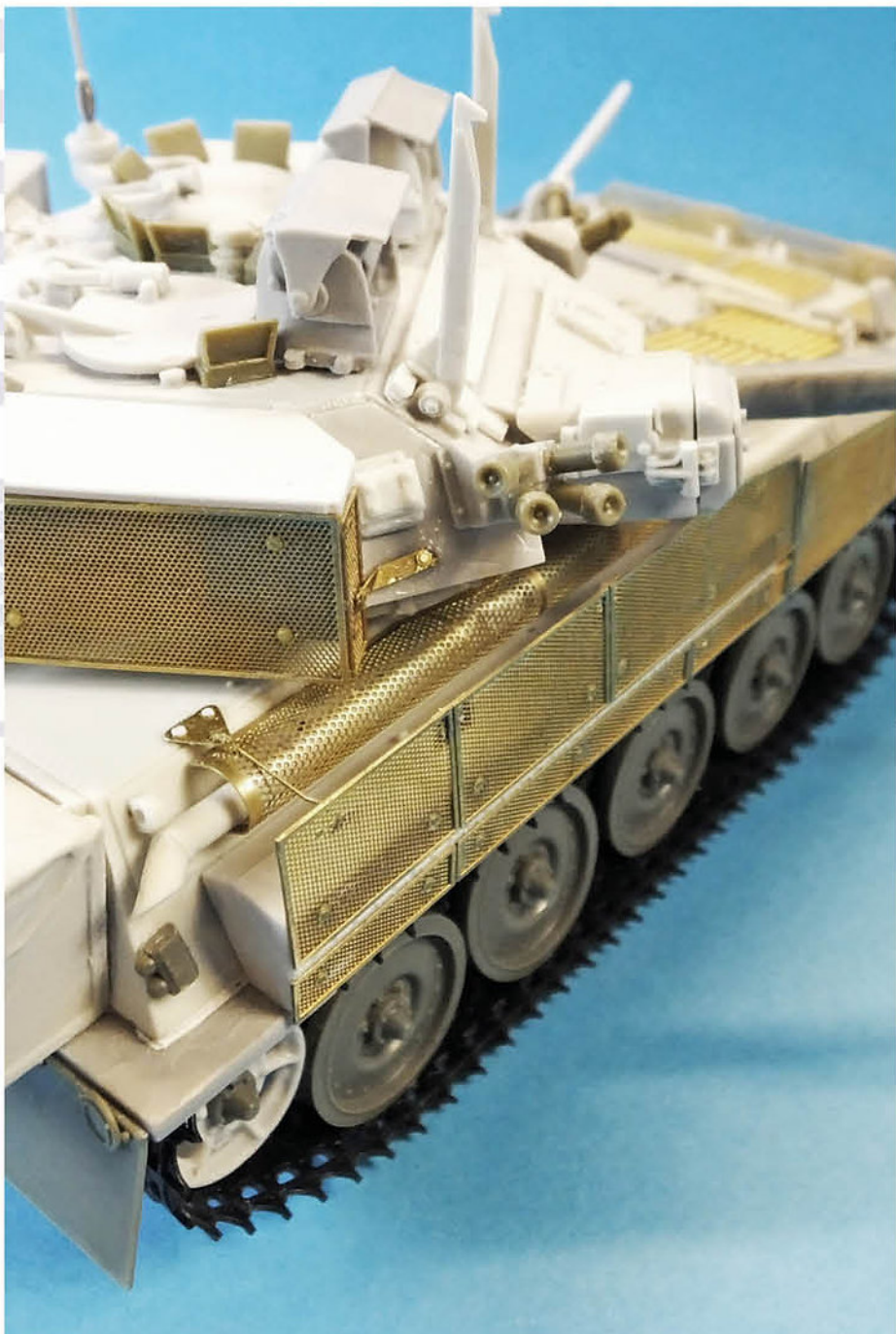
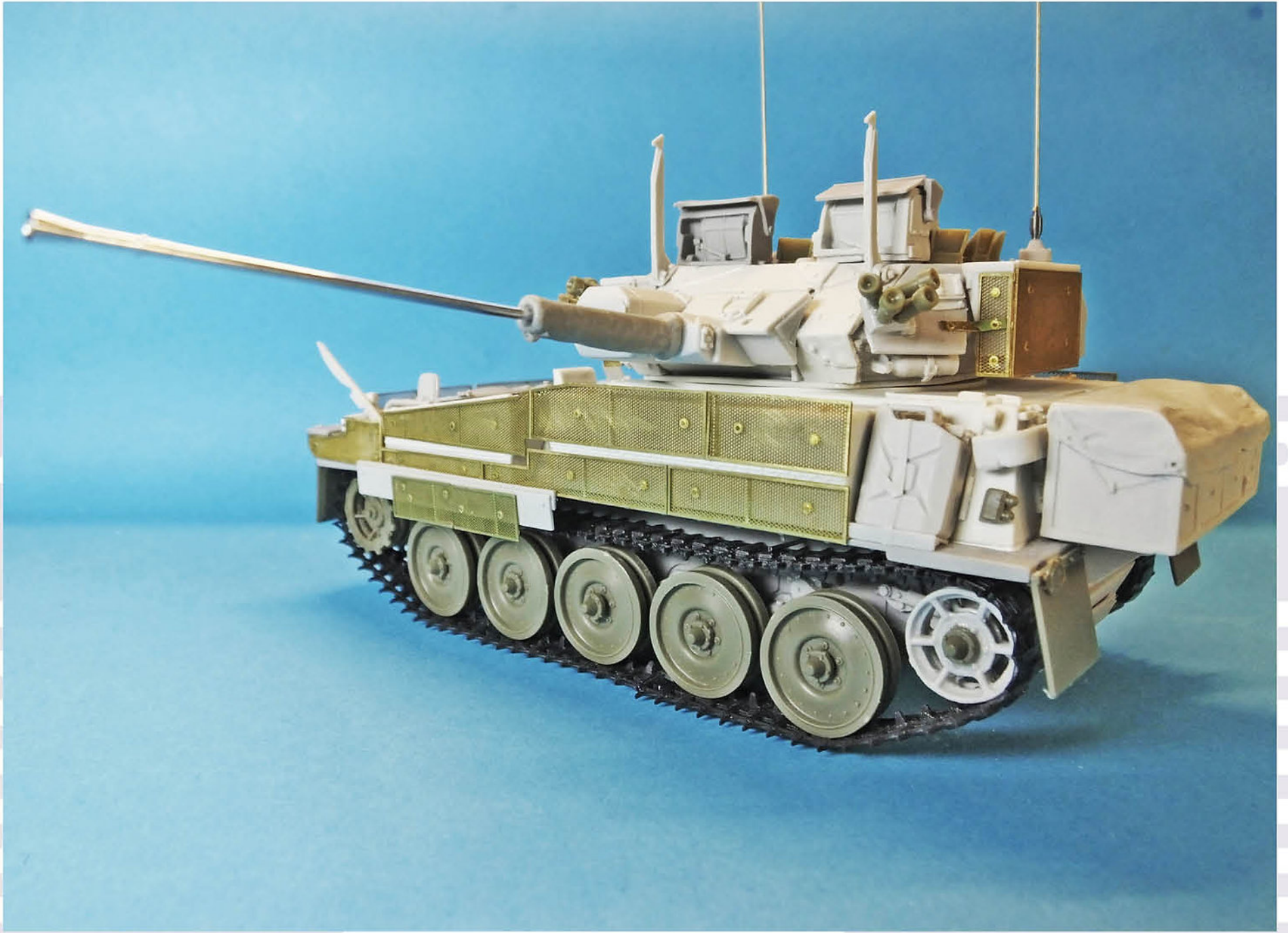





Photos courtesy of Andy Brend, Bob Wood and Martyn Smith.

<https://www.scorpion-miniature-models.co.uk/shop>

Please check your own references for all changes. Happy modelling and keep on building!



## Hong Kong Creation Workshop

Unit 608, Block 5, Nan Fung Industrial City,  
18 Tin Hau Road, Tuen Mun, HONG KONG  
+852 2433 0533

<http://www.anc-creation.com/en/index.php>

© HKCW 2020

**Master parts built by Andrew Crutchley**



*This product is not a toy and is for experienced modellers only.*

*For bonding parts use cyano-acrylate (super-glue). Follow the safety instructions on the bottle. Use only in a well-ventilated room. Keep tools, adhesives and solvents out of reach of children and pets.*