



NÁVOD / INSTRUCTION

SH72155 P-40F Warhawk "Short Tails over Africa" 1/72

CZ - Historie

P-40E/Kittyhawk Mk.IA nevykonal výkony ve větších výškách. Bylo to dáno vlastnostmi použitého motoru Allison V-1710-39. Firma Curtiss se tuto nechtost pokusila vyřešit montáží v USA licenčně vyráběného motoru Rolls-Royce Merlin 28 do trupu P-40. Kromě odlišné vedených vstupů vzduchu, jiné paneláže přidě a zvětšených nádrží v křídle se nová verze nijak neodlišovala od P-40E.

První prototyp nové verze P-40F Warhawk vzletěl 30. června 1941. Na základě úspěšných zkoušek byla objednána sériová výroba 689 kusů výrobního bloku P-40F-1. Protože se u P-40F objevily problémy se směrovou stabilitou a vybočováním při startu, další výrobní bloky od P-40F-5 měly ocasní část trupu prodlouženou o 48 cm. Tento prodloužený trup se pak používal u všech pozdějších verzí P-40. P-40F se dostaly do výzbroje jednotek US Army i dalších spojeneckých sil. US Army je nasadilo poprvé v operaci Torch, při vylodění v Africe. Dalším bojištěm byla oblast jihozápadního Pacifiku a P-40F sloužily také na území USA, jak u bojových, tak cvičných jednotek. RAF je zařadilo do výzbroje 3. (RAAF) a 450. sq. RAAF bojujících v Africe a posléze v Itálii. Britové označovali tyto stroje, jak s krátkými, tak dlouhými trupy, jako Kittyhawk Mk.II. Letectvo svobodné Francie získalo P-40F pro přezbrojení jednotky SPA 167, taktéž operující v severní Africe. Přibližně 100 ks mělo údajně dostat letectvo Rudé Armády.

Nejúspěšnější akcí P-40F byl palmě známý Palm Sunday Massacre, kdy 18. dubna 1943 zaútočilo 46 Warhawků od 57. a 324. sq. US Army s výškovým zajištěním 11 Spitfirů na přibližně 60 transportních letounů Luftwaffe se stíhacím doprovodem. Při ztrátě pouhých šesti Warhawků bylo ohlášeno sestřelení 59 transportních letadel a šestnácti doprovodných stíhaček.

Technická data:

rozpětí: 11,38 m, délka P-40F-1/P-40F-5: 9,50 m/10,16 m, max. rychlost: 586 km/h, dolet: 965 km, dostup: 10 458 m, stoupavost 16,5 m/s

EN - History

Due to its powerplant Allison V-1710-39 engine P-40E/Kittyhawk Mk.IA had low performances in higher altitudes. Curtiss Company tried to resolve this bad feature by installation of license built Rolse Royce Merlin 28 into P-40 fuselage. The new version featured different air ducts, nose panel covers and enlarged wing fuel tanks the rest of the aircraft was same as P-40E.

The first prototype of the new P-40F version took off on 30 June 1941. Based on the successful trials the series production of 689 P-40F-1 aircraft was ordered. Since this new P-40F-s had stability troubles from P-40F-5 block the aircraft was lengthened in tail section by 48 cm. This lengthened fuselage was a standard feature of all subsequent P-40 versions.

P-40F-s were used by US Army and other Allied air forces. The very first combat assignment by US Army was Operation Torch the Allied landing in North Africa. Other operational theatre was South West Pacific and continental USA land with both training and combat units. RAF assigned P-40F-s to 3rd and 450th RAAF squadrons deployed to North Africa and later to Italy. Official British designation of the type was Kittyhawk Mk.II.

Free French Air Force received P-40F-s to re-equip SPA 167 unit also fighting in North Africa. It is said that probably 100 aircraft were delivered to USSR.

The most successful P-40F-s combat action was Palm Sunday Massacre on 18 April 1943. Forty six US Army Warhawks from 57th and 324th Fighter Groups with cap cover of 11 Spitfires attacked around 60 Luftwaffe transport aircraft with escort fighters. With loosing only six own aircraft, pilots claimed 59 transport and 16 escort fighter aircraft shot down.

Technical Data:

Wingspan: 11.38 m, Length P-40F-1/P-40F-5: 9.50 m/10.16 m, Max. Speed: 586 km/h, Ceiling: 10458 m, Range: 965 km, Service climbing: 16.5 m/s.

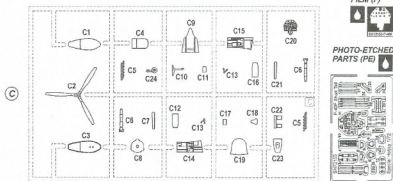
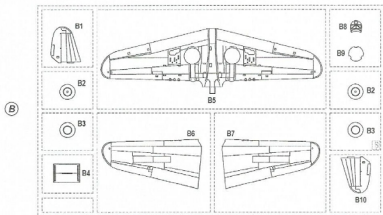
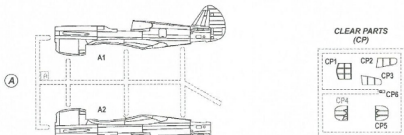

SYMBOLS

? МОЖНОСТЬ ВОЛКЯ
OPTIONAL
NACH BELEBEN
OPTION

☉ ПОЛІТИ ЛІПІДО НА КОВ
POLYMER GLEIE FOR METAL
METALL LÖTLÖSEN
COLLE A METAL

|| РЕЗАТЬ/RIJKAT
CUT OFF/ENTWELLEN
ENTWELLEN
DETACHER

✋ ЗНОСИТИ НОВЕ
SCHRAFFEN (BLU.D.)
FERTIGSTELLEN
ACHEVER

🌀 ОДНОКІТ
BEGEN
COLURBERE

🎨 COLOURS CODE
LUTRIT
COLOUR
FARBEN
PENSJEL



Barvy GUNZE/ GUNZE Color No.

A	Měkká/ ALUMINIUM	H8C8
B	Zlatozelená/ ZINC CHROMATE	C352
C	Bílá/ White	H9C1
D	Černá/ BLACK	H12/C33
E	Interier zelená/ INTERIOR GREEN	C361
F	Příloha/ LINEN	H85C46
G	Černá Průsvl/ TIRE BLACK	H77C137
H	Opalovaný Kovač/ BURNY METAL	MC214
I	Kůže/ LEATHER	H17C29

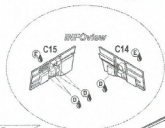
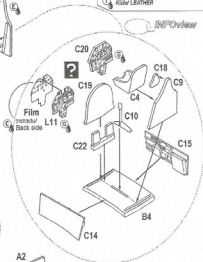
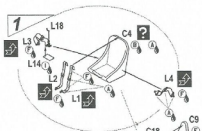

2

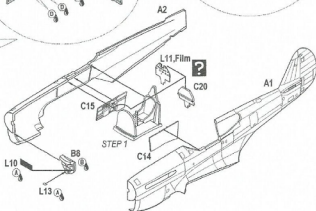

3

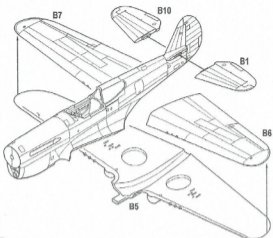

4

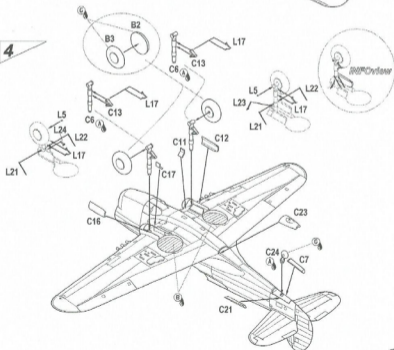

5

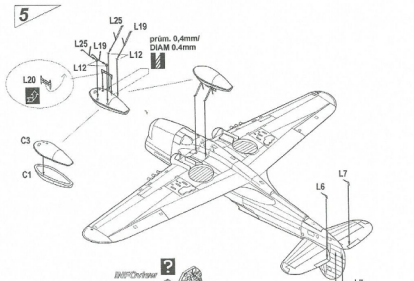

6

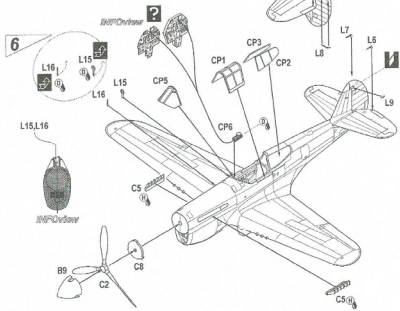

P-40F-1 Warhawk, "7-8", 66.FS "Exterminators", 57. FG, polovina roku 1942. Pod směrovkou jsou vidět zbytky původní olivové barvy. Letoun byl velmi očouzen výtokovými zplodinami.

CAM. A

P-40F-1 Warhawk, "7-8", 66th FS "Exterminators", 57th FG, mid 1942. The traces of original Olive Drab color are present on the lower part of the rudder. The aircraft had heavy exhaust stains.

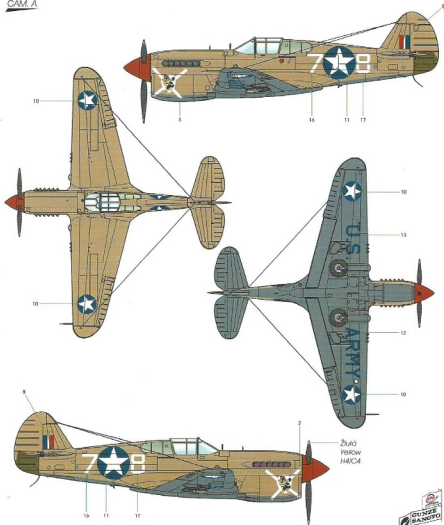

- | | | | | |
|---|---|---|---|---|
|  |  |  |  |  |
| Písková 26
Sand 26
H27/C44 | Olivová 41
Olive Drab 41
H52/C12 | Světle šedá 43
Neutral Grey 43
H53/C13 | Matná černá
Flat Black
H12/C33 | Červená
Red
H3/C3 |



P-40F-1 Warhawk, "Jo", 64. FS, 57. FG, USS Ranger, červen 1942. Pod výškovkou a směrovkou jsou vidět zbytky původní olivové barvy.

CAM. 8

P-40F-1 Warhawk, "Jo", 64th FS, 57th FG, USS Ranger, June 1942. The traces of original Olive Drab color are present on the lower part of the rudder and below the vertical stabilizer.

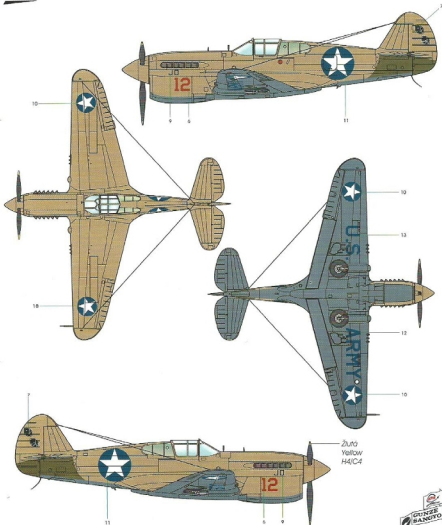

Písková 26
Sand 26
H27/C44

Olivová 41
Olive Drab 41
H52/C12

Světle šedá 43
Neutral Grey 43
H53/C13

Matná černá
Flat Black
H12/C33

Červená
Red
H3/C3

Žlutá
Yellow
H4/C4



SH72155 P-40F "Short Tail"

P-40F-1 Warhawk, ser. 4114216, X6-D, 86. FS, 79. FG, Severní Afrika, 1942. Tento letoun nesl novou pouštní kamufláž sestávající ze světlé pískové a zemitě hnědé barvy na horních plochách a světlé modré na spodních.

CAM. C

P-40F-1 Warhawk, s/n 4114216, X6-D, 86th FS, 79th FG, North Africa, 1942. This aircraft sported new desert camouflage consisting of Light Desert Sand and Earth Brown on upper surfaces and Light Blue on lower ones.

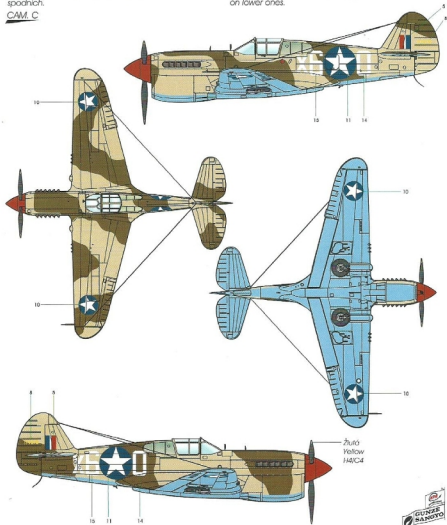

	Světlá písková Light Desert Sand H313/C313		Zemitě hnědá Earth Brown H72/C22		Světlá modrá Light Blue C370		Matná černá Flat Black H12/C33		Červená Red H3/C3
---	---	---	--	---	------------------------------------	---	--------------------------------------	---	-------------------------

SH72155 P-40F "Short Tail"

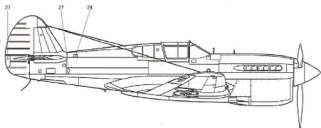
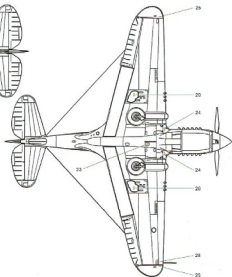
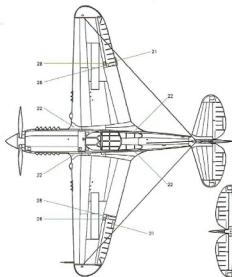
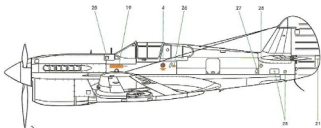

SH72120

Plastic molding
with Photo - etched parts*F-86H Sabre Hog*

SH72144

Plastic molding with PUR
and Photo - etched parts*F-86L Sabre Dog*

SH72106

Plastic molding with PUR
and Photo - etched parts*F3F-2 Flying Barrel*

SH72058

Plastic molding
with PUR parts*P-59A/B Airacomet*

SH72064

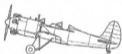
Plastic molding
with PUR parts*RYAN PT-22*

SH72132

Plastic molding with PUR
and Photo - etched parts*Northrop XP-56 II*

SH72133

Plastic molding
with PUR parts*F2A-2 Buffalo
"Yellow Wing"*

SH72071

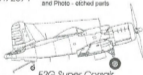
Plastic molding with PUR
and Photo - etched parts*F2G Super Corsair*

SH 72093

Plastic molding
with PUR parts*PV-2 HARPOON U.S. NAVY*