

# PANZER I Ausf A early version



	切除阴影部分 Cut away		安装箭头 Install arrow		另一侧相同制作 Repeat opposite side
	锉平阴影部分 Rasp away		弯折箭头 Fold arrow		使用圆棒制作 Use ABS rod
	填补 Use filler		蚀刻片零件标号 Number of PE parts		注解一 Note 1
	弧度弯折 Bend		原套件零件标号 Number of original parts		根据喜好选择安装 Optional
	钻孔 Make a hole		被替换的零件标号 Number of replaced parts		制作所示若干组 Make some pcs

1/35 MILITARY MINIATURE VEHICLE PE UPGRADE SERIES NO. 201

PE UPDATE For DML6289

**RECOMMENDED TOOLS**  
推荐使用工具



美工刀  
Modeling knife

笔钻  
Pin vise

镊子  
Tweezers

尖嘴钳  
Needle-nose pliers

快干胶  
super glue

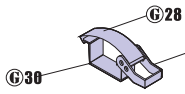

**A**

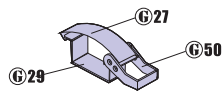

**B**

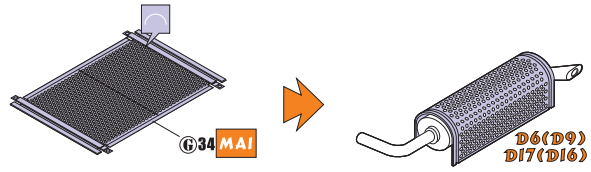

**C**

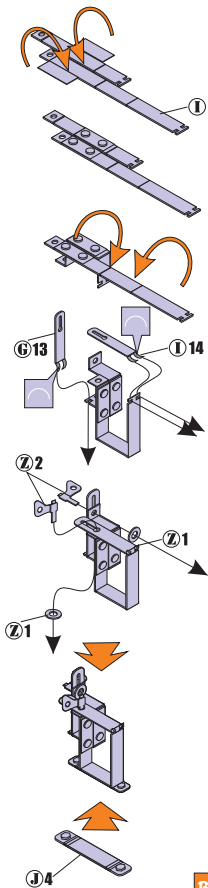

**D**

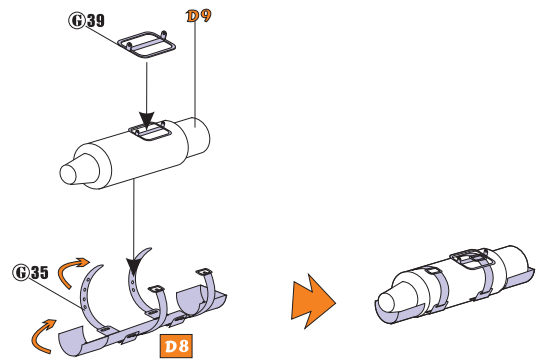
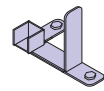
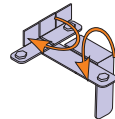
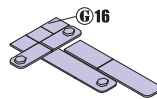
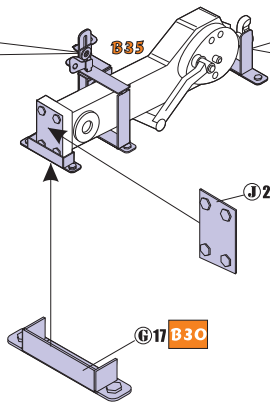

**E**

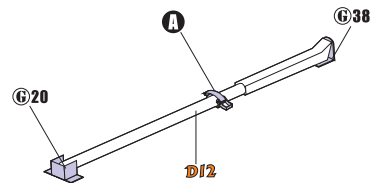

**F**

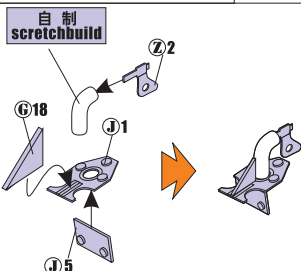

**H**

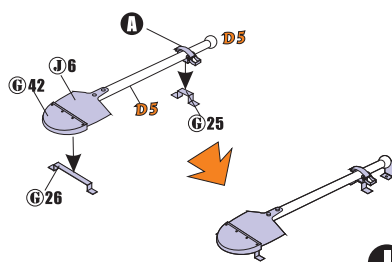

**I**

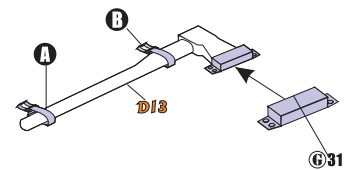

**J**



**U**

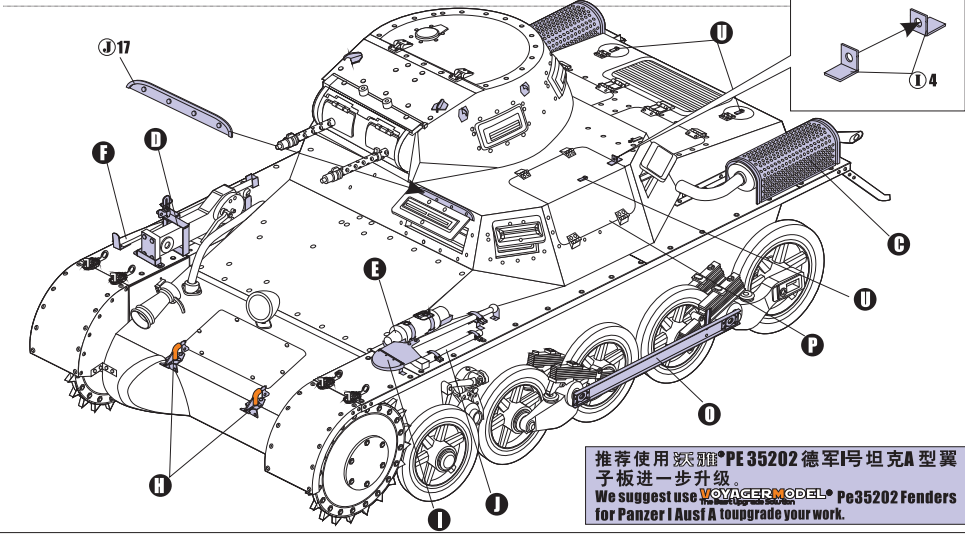
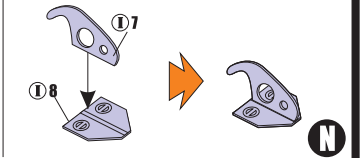
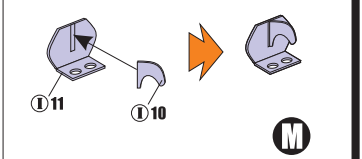
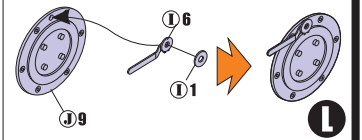
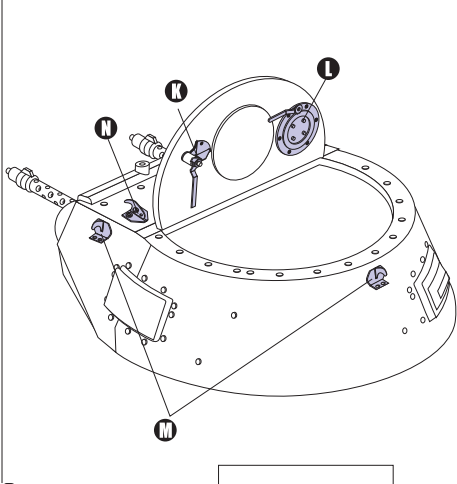
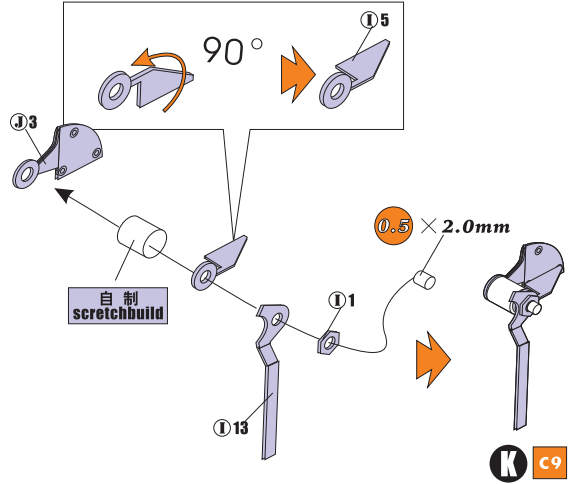

推荐使用 翼子板 PE 35202 德军 I 号坦克 A 型翼子板进一步升级  
We suggest use **VOYAGERMODEL®** Pe35202 Fenders for Panzer I Ausf A tougrade your work.

