

**eduard**  
**Express Mask**

**XL 035**

# F-4E Phantom II

The die-cut mask for accurate canopy frame painting of the  
*Tamiya 1/32 KIT ITEM 60310*

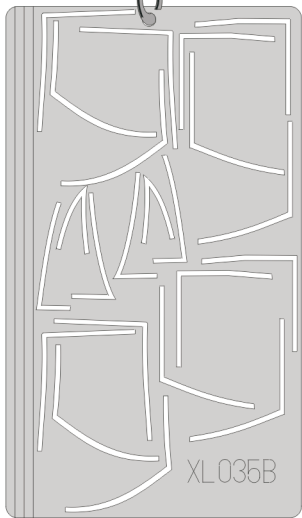
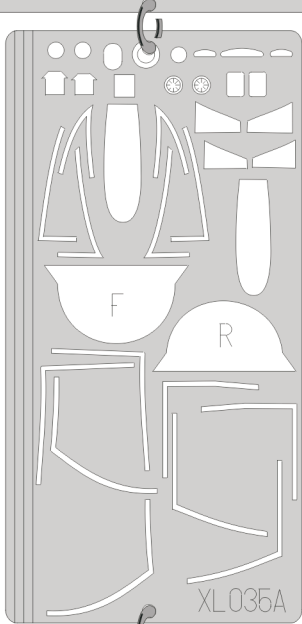

**2pcs**  
**D17**



**D18**

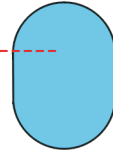

**2pcs**

**D2**

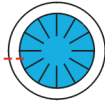

**L28**

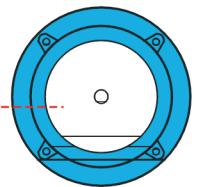

**L46**

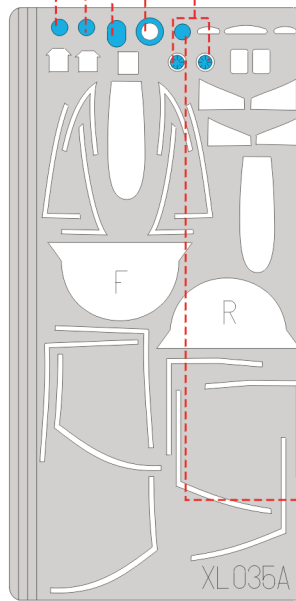
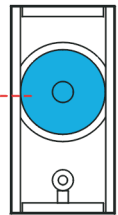

**D6**

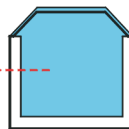

**D6**

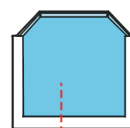

**D1**

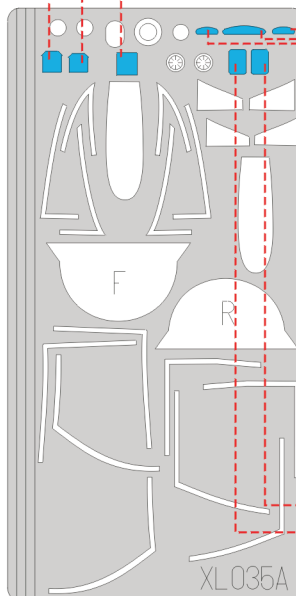
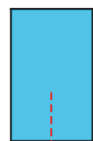

**F27**

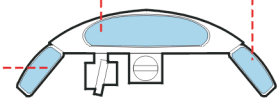

**D13**

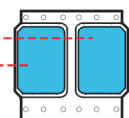

**REFERENCES:**

IN DETAIL & SCALE VOL.7 - F-4 PHANTOM II

REPLIC #53 / 1996

REPLIC #57 / 1996

REPLIC #125 / 2002

**LIQUID MASK**



1.)

D5

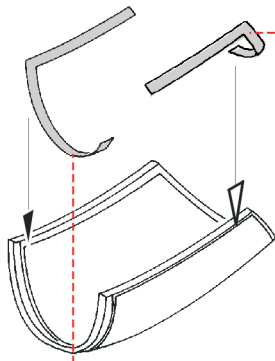

1.)

D6

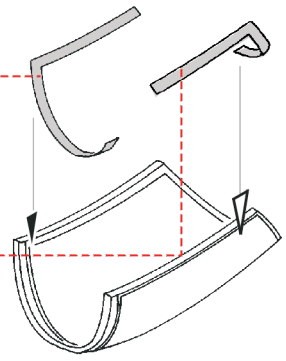

2.)

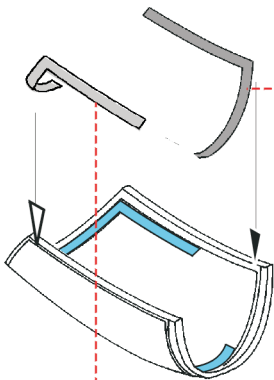

2.)

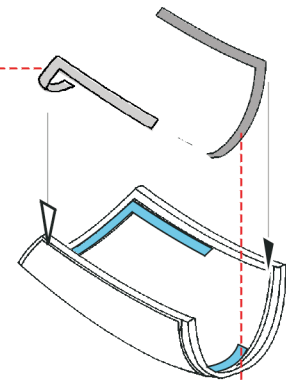

3.)

INTERIOR COLOR

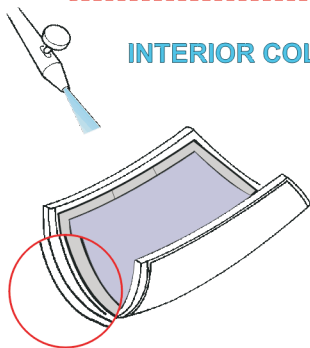

D5

3.)

INTERIOR COLOR

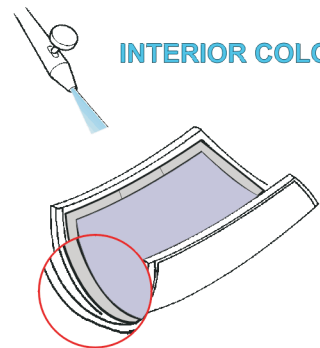

D6

1.)

INTERIOR COLOR

D3

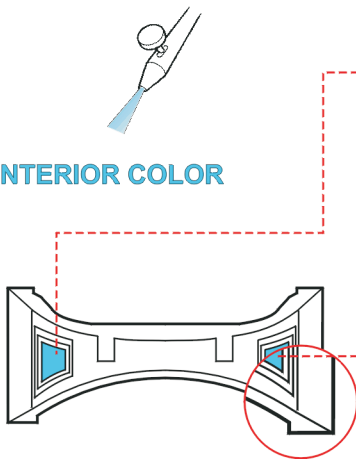

2.)

RUBBER COLOR

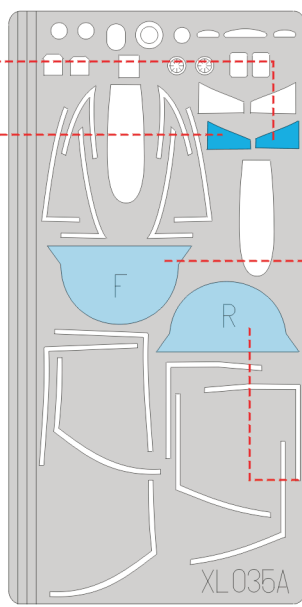
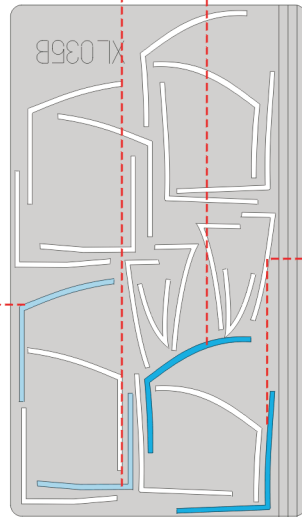
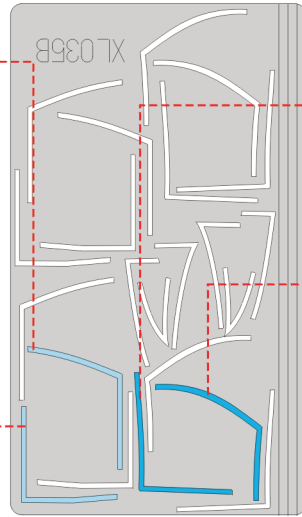
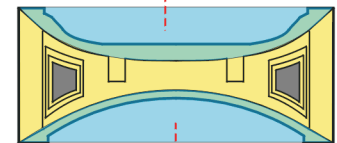

3.)

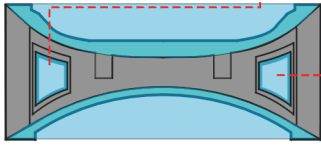

CAMOUFLAGE COLOR

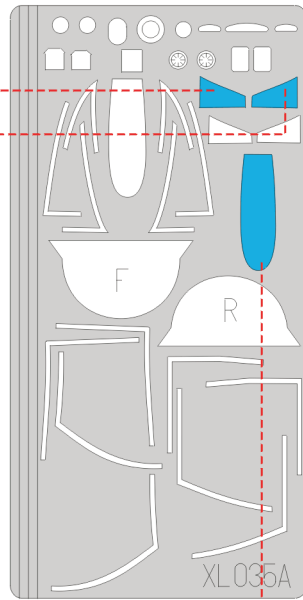

4.)

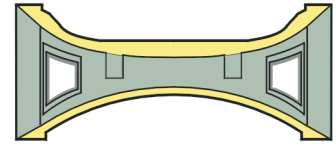

1.)

D4

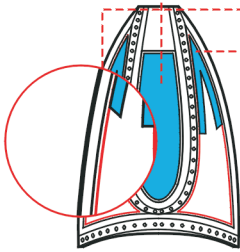

2.)

D4

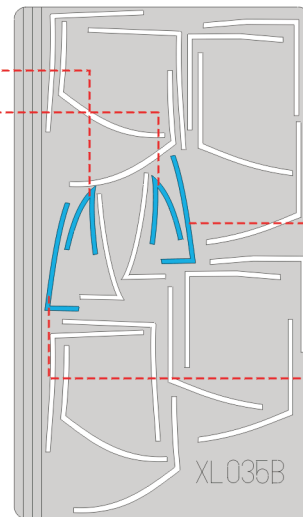
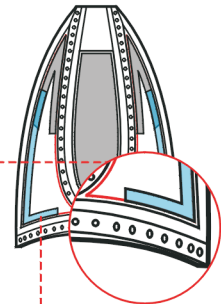

3.)

D4

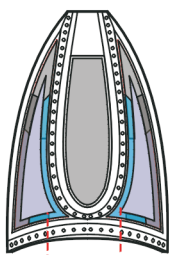

INTERIOR COLOR

4.)

D4

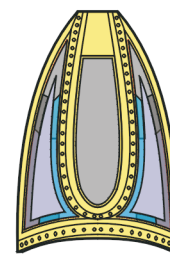

RUBBER COLOR

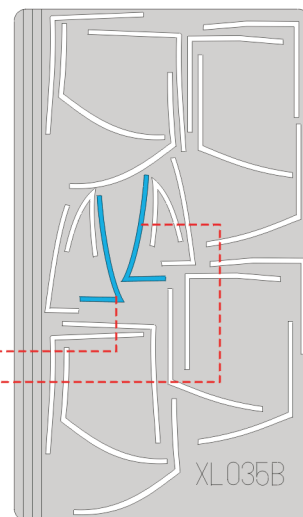

5.)

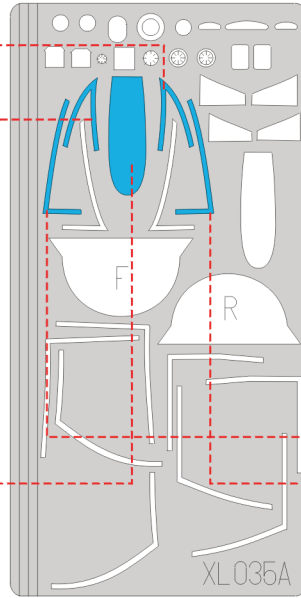
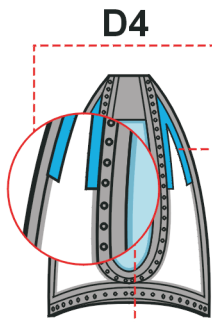

6.)

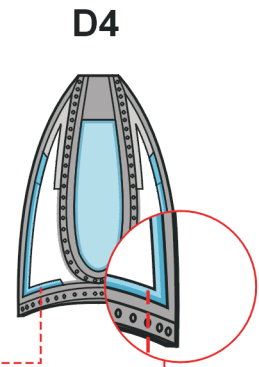

7.)

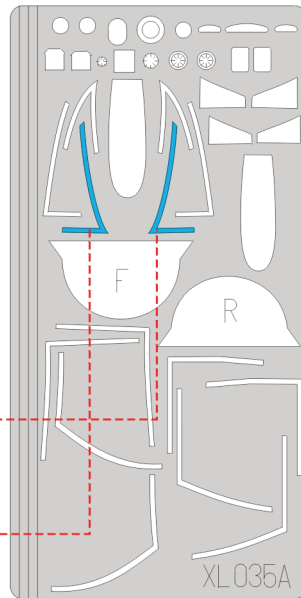
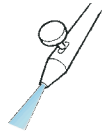
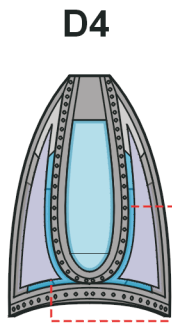

8.)

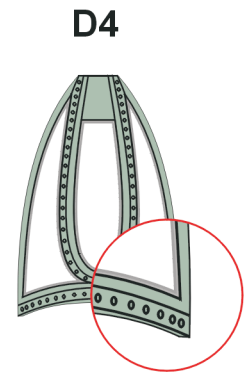

CAMOUFLAGE COLOR

1.)

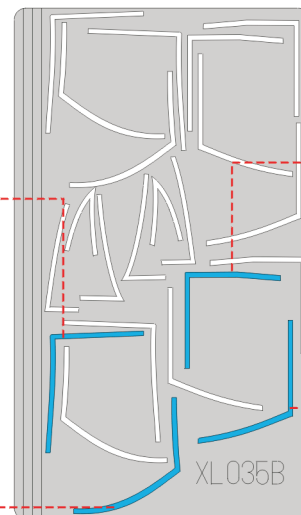
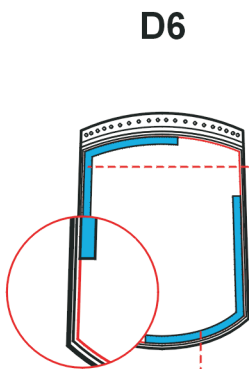

D5

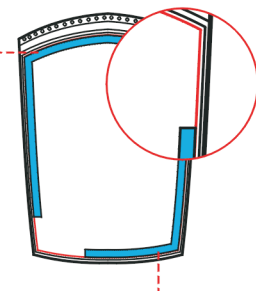

2.)

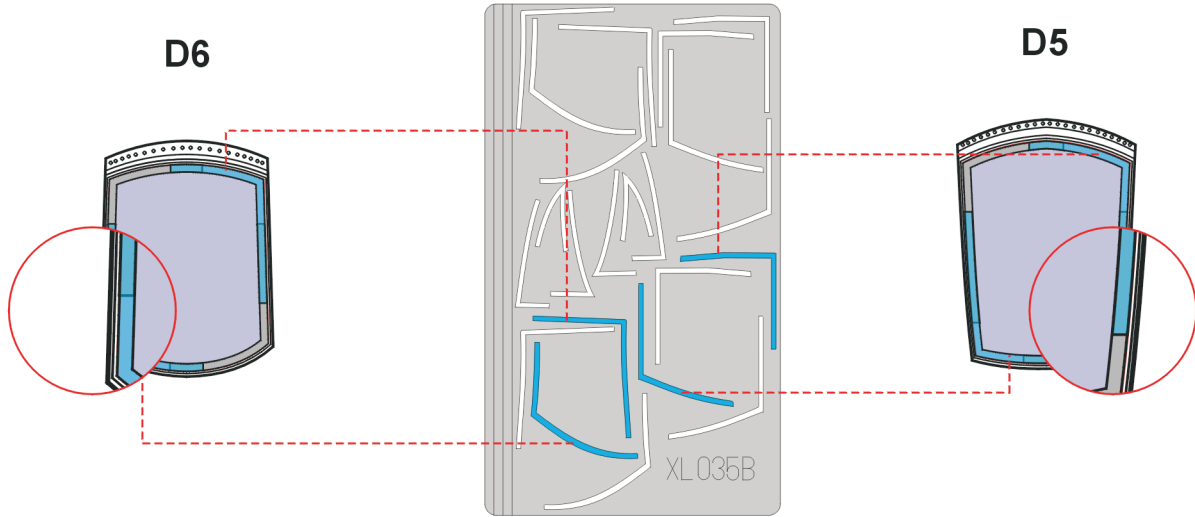

3.)

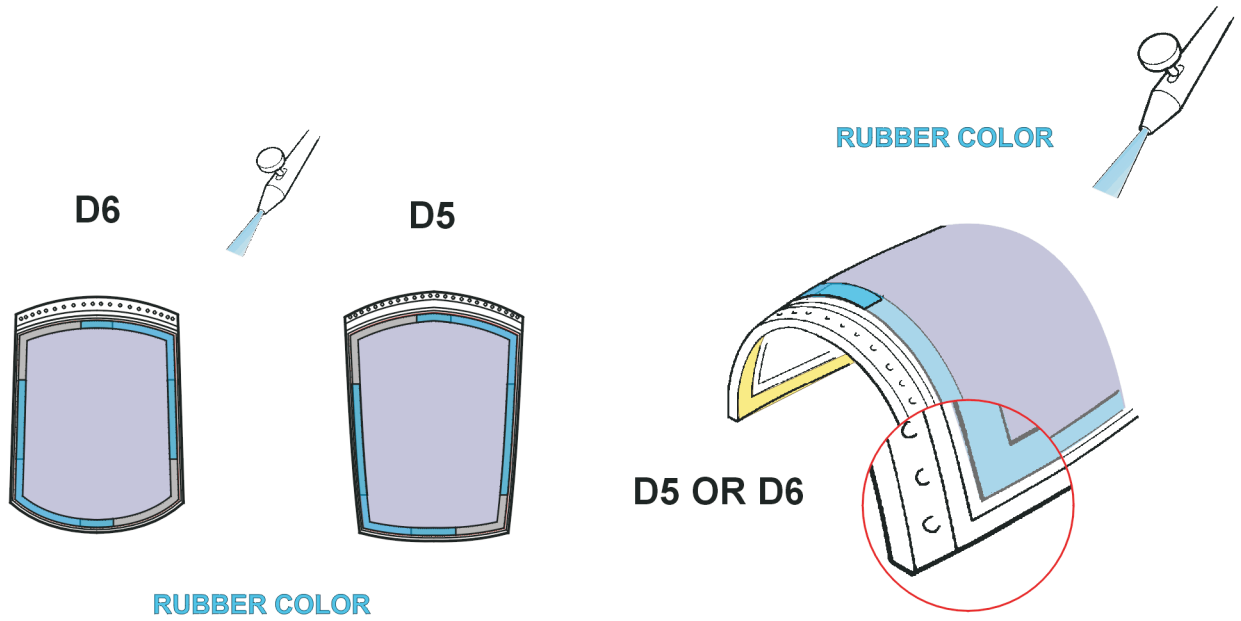

4.)

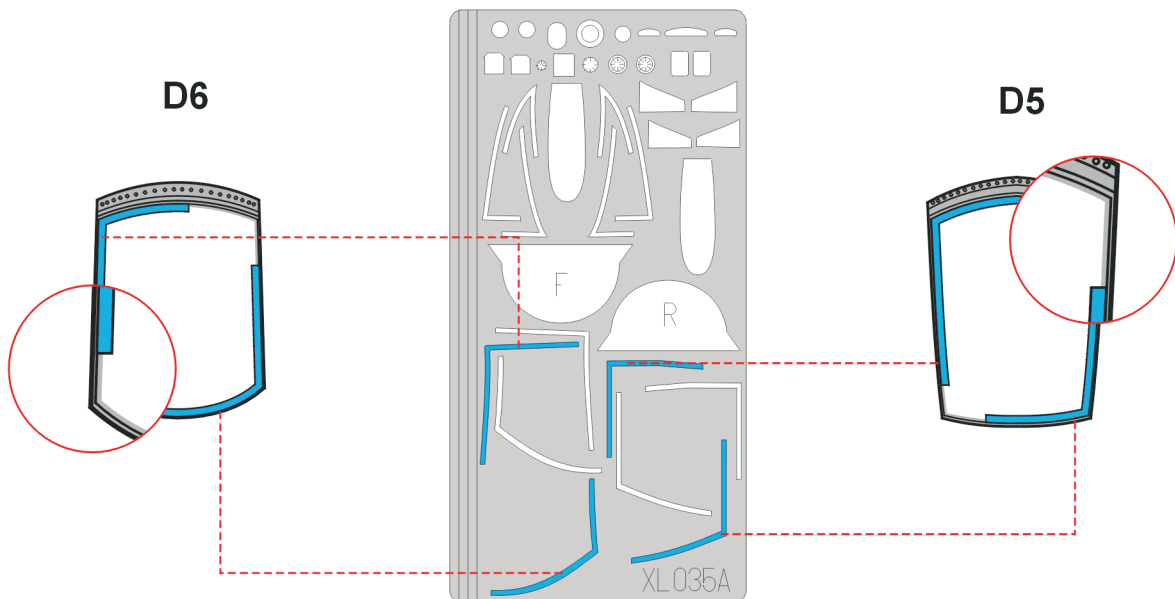

5.)

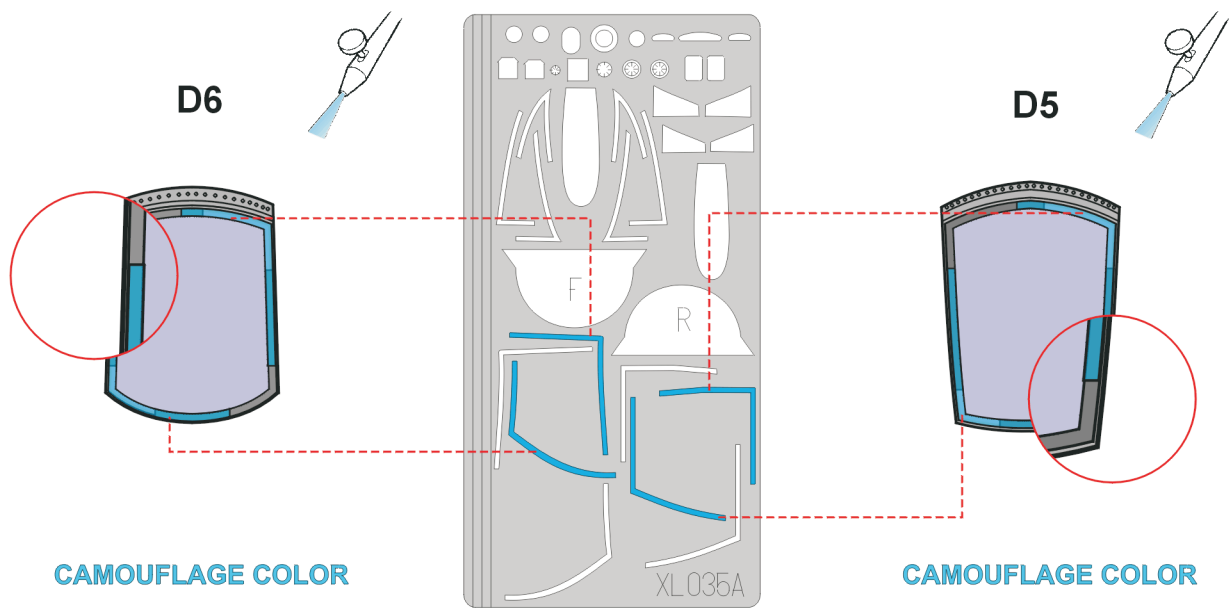

6.)

