

# F-22A

## PART 1

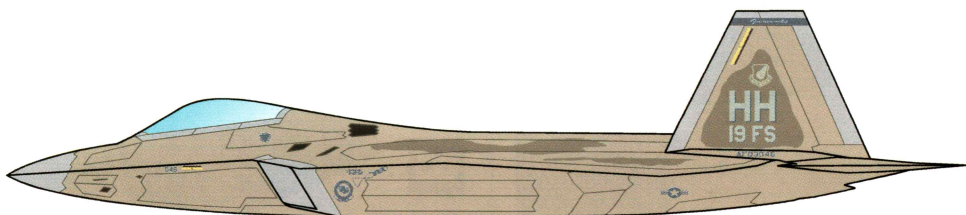
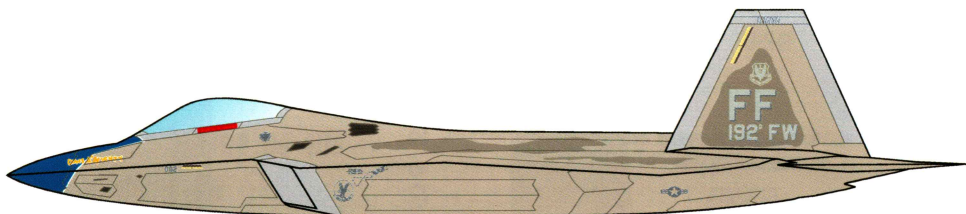
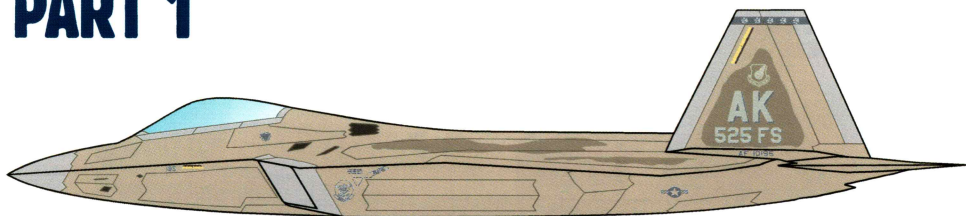

**14 MARKING OPTIONS  
FOR USAF F-22 AIR SUPERIORITY FIGHTERS**

**1/72 SCALE**

**DECALS PRINTED BY**



# COMMON MARKINGS & STENCILING

SOME MARKINGS SHOWN IN BLACK FOR CLARITY

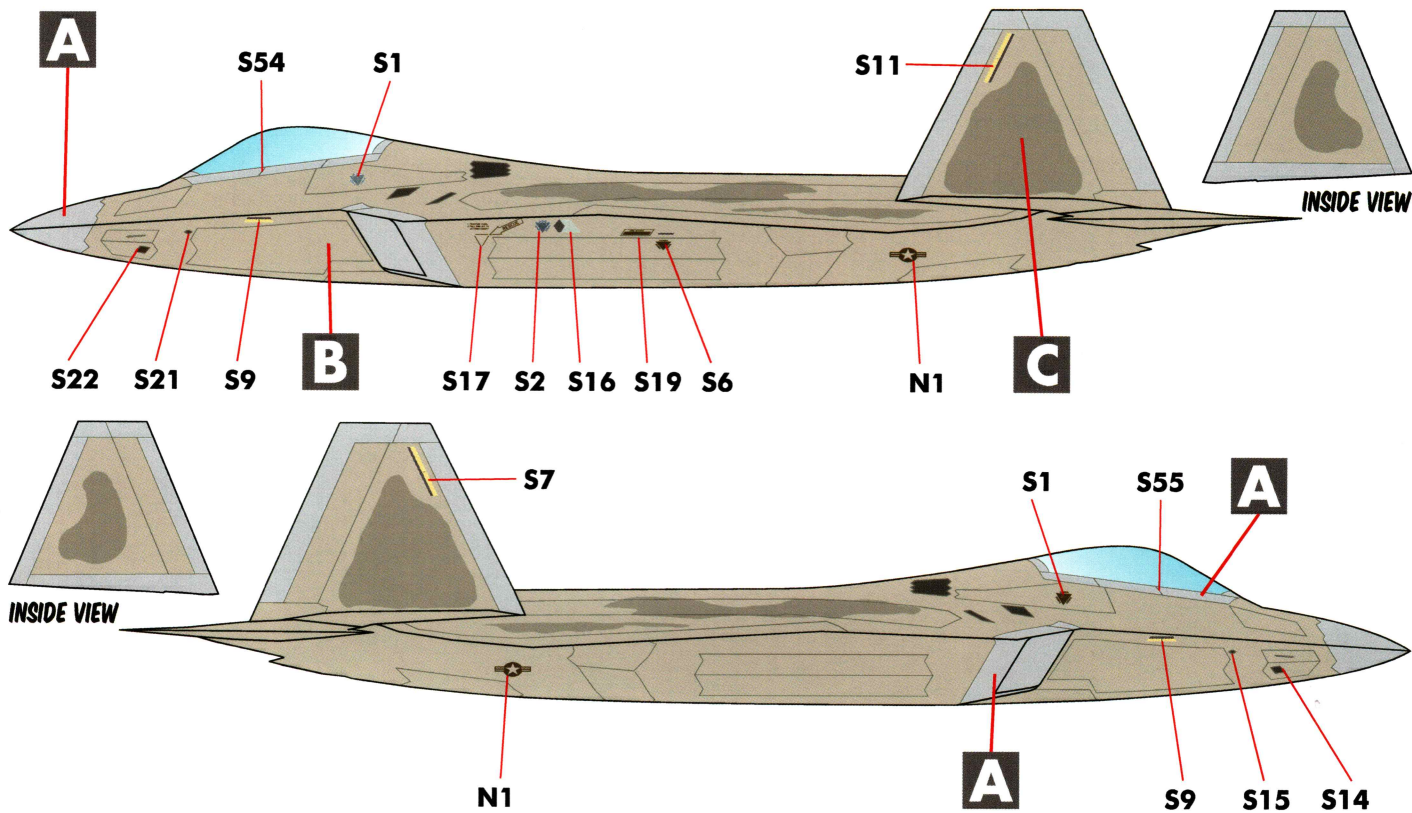

**OPTION 1: F-22A RAPTOR 10-4193**  
**3WG, ELMENDORF AFB**

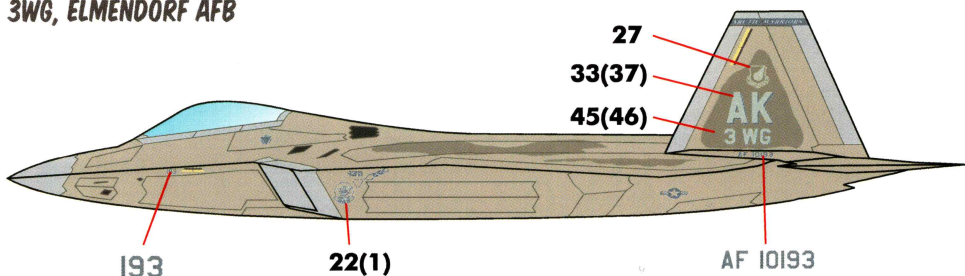

**OPTION 2: F-22A RAPTOR 10-4195**  
**525FS, ELMENDORF AFB**

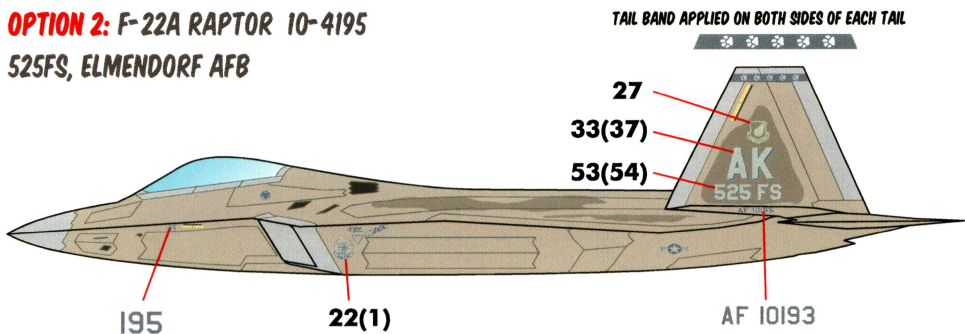

**OPTION 3: F-22A RAPTOR 06-4115**  
**525FS, ELMENDORF AFB**

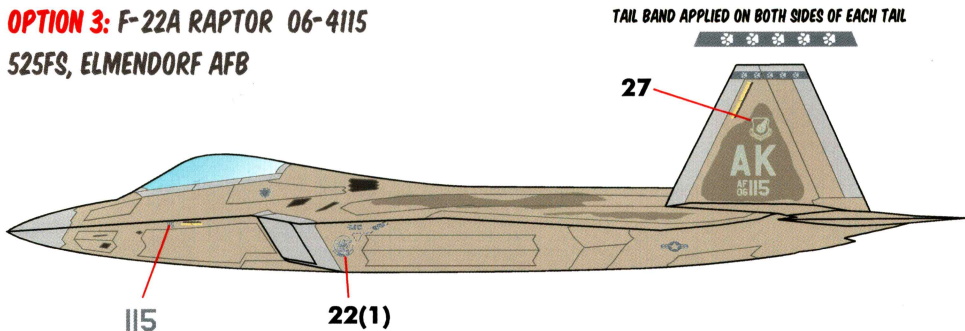

**OPTION 4: F-22A RAPTOR 06-4132**  
**411 FLTS, EDWARDS AFB**

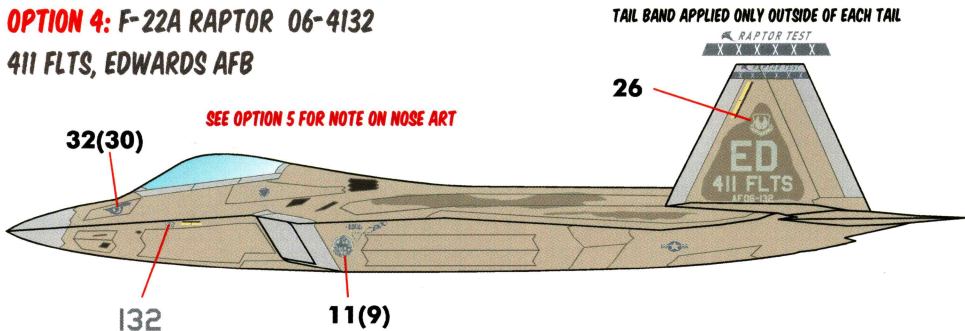

**OPTION 5: F-22A RAPTOR 91-4009**

411 FLTS, EDWARDS AFB

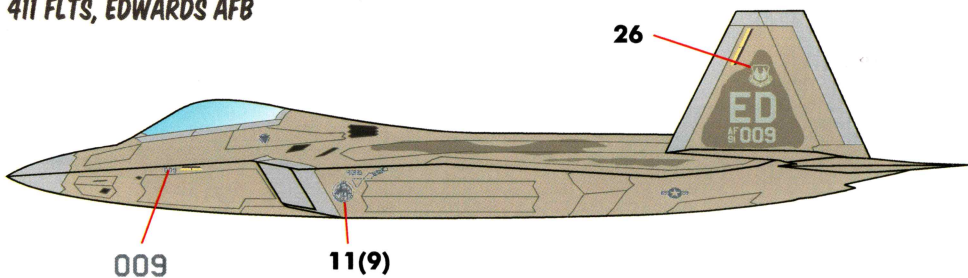

OPTIONS 4 AND 5 ARE AMONG THE F-22 COMBINED TEST FORCE (CTF) JETS THAT CARRY NOSE ART ON THE PORT SIDE.

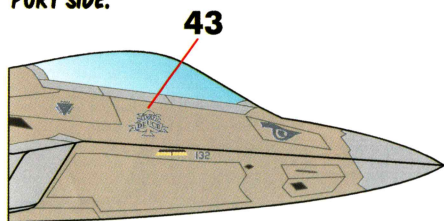

**OPTION 4 - "ACE TREY DEUCE" (132)**

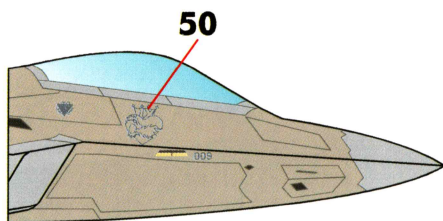

**OPTION 5 - "IX" (009)**

**OPTION 6: F-22A RAPTOR 04-4082 "CRIPES A'MIGHTY"**

192FW, LANGLEY AFB

TAIL BAND APPLIED ON BOTH SIDES OF EACH TAIL

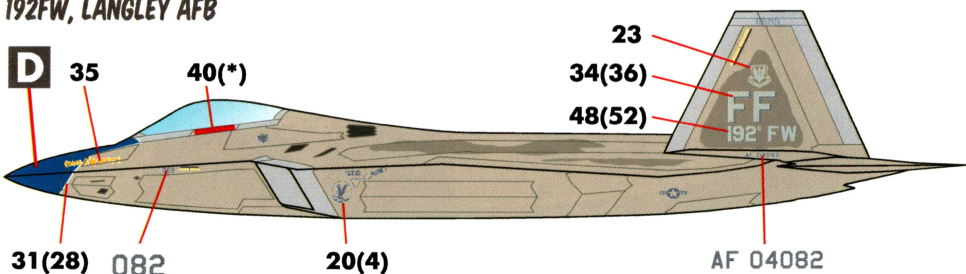

IT IS LIKELY THAT THIS JET WAS DECORATED ONLY FOR PHOTOGRAPHY PURPOSES AND NEVER FLEW IN THIS SCHEME. PLEASE E-MAIL US IF YOU HAVE MORE INFORMATION.

**OPTION 7: F-22A RAPTOR 05-4094**

94FS, LANGLEY AFB

TAIL BAND APPLIED ON BOTH SIDES OF EACH TAIL

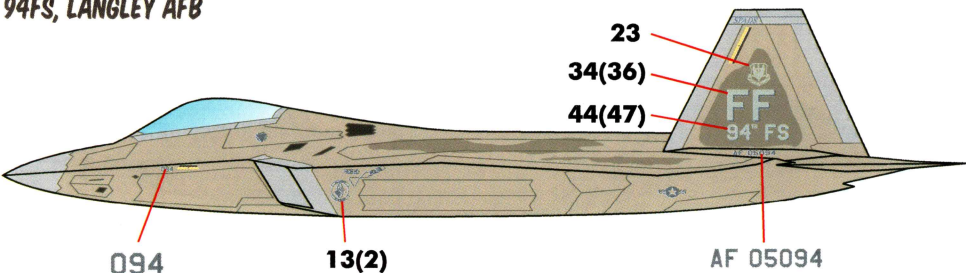

**OPTION 8: F-22A RAPTOR 05-4085**  
 94FS, LANGLEY AFB

TAIL BAND APPLIED ON BOTH SIDES OF EACH TAIL  
 SPADS

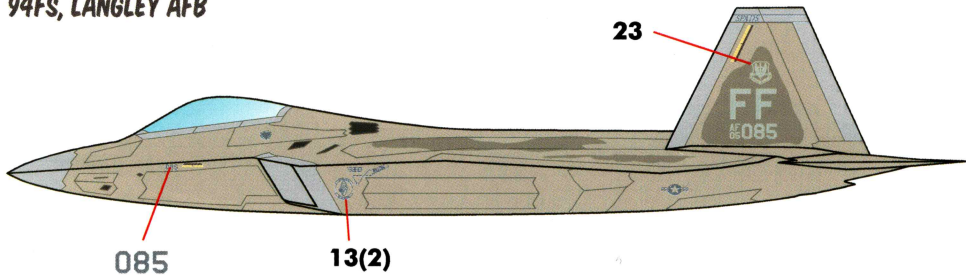

**OPTION 9: F-22A RAPTOR 03-4046**  
 19FS, HICKAM AFB

TAIL BAND APPLIED ONLY OUTSIDE OF EACH TAIL  
 Hammerheads

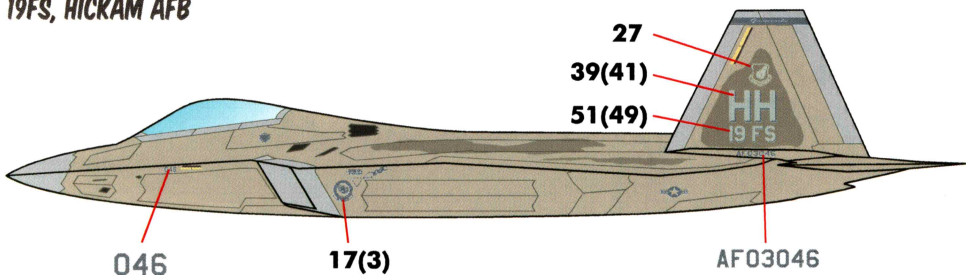

**OPTION 10: F-22A RAPTOR 03-4052**  
 19FS, HICKAM AFB

TAIL BAND APPLIED ONLY OUTSIDE OF EACH TAIL  
 Hammerheads

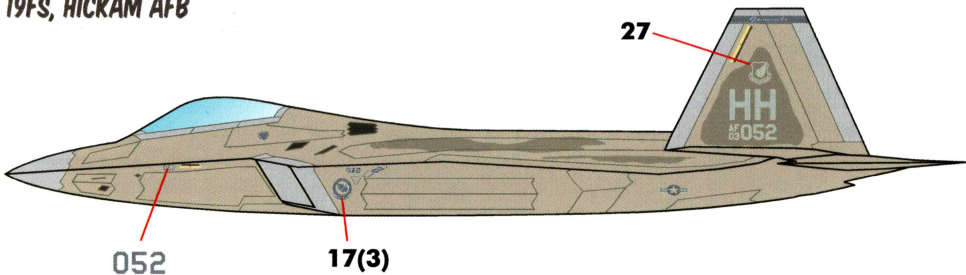

**OPTION 11: F-22A RAPTOR 04-4072**  
 8FS, HOLLOMAN AFB

TAIL BAND APPLIED ONLY OUTSIDE OF EACH TAIL  
 BLACK DRIP

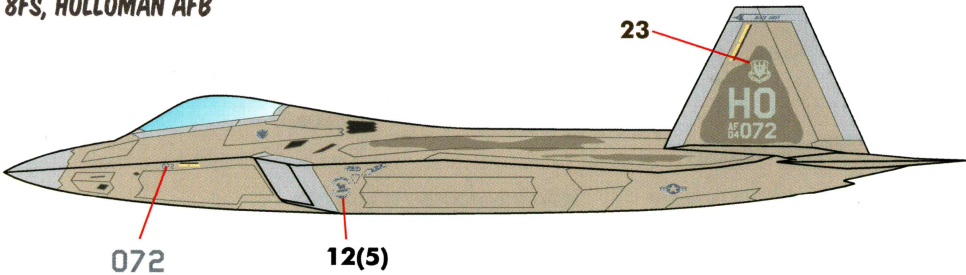

**OPTION 12: F-22A RAPTOR 01-4022**

43FS, TYNDALL AFB

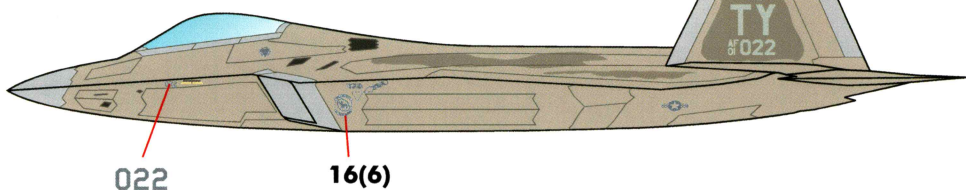

**OPTION 13: F-22A RAPTOR 06-4116**

433 WPS, NELLIS AFB

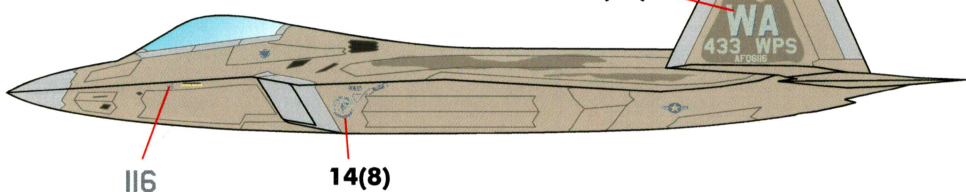

**OPTION 14: F-22A RAPTOR 06-4109**

433 WPS, NELLIS AFB

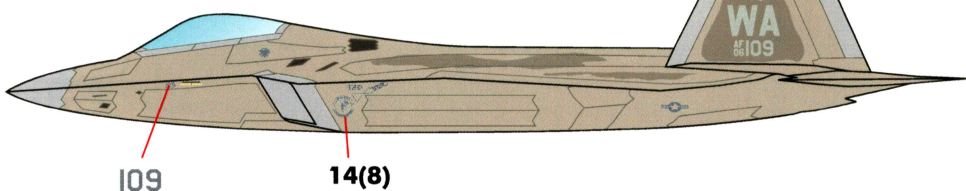

**CANOPY DETAILS**

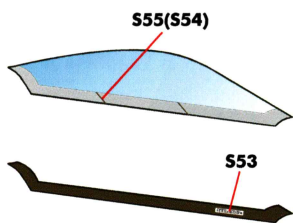

**INTAKE COVERS**

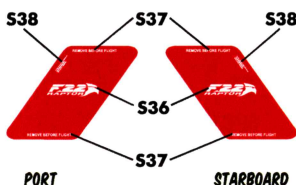

APPLY THIS PROMINENT MARKING ON THE CANOPY INNER FRAME ON THE PORT SIDE. SEE THE REFERENCE PAGE FOR PHOTOS THAT SHOW THE AREA.

MARKINGS FOR STANDARD F-22 INTAKE PLUGS ARE SHOWN. PLEASE VISIT THE REFERENCE PAGE FOR PHOTOS AND INFORMATION ON RESIN PARTS AVAILABLE FROM BAM MODELS.

# TOP VIEW

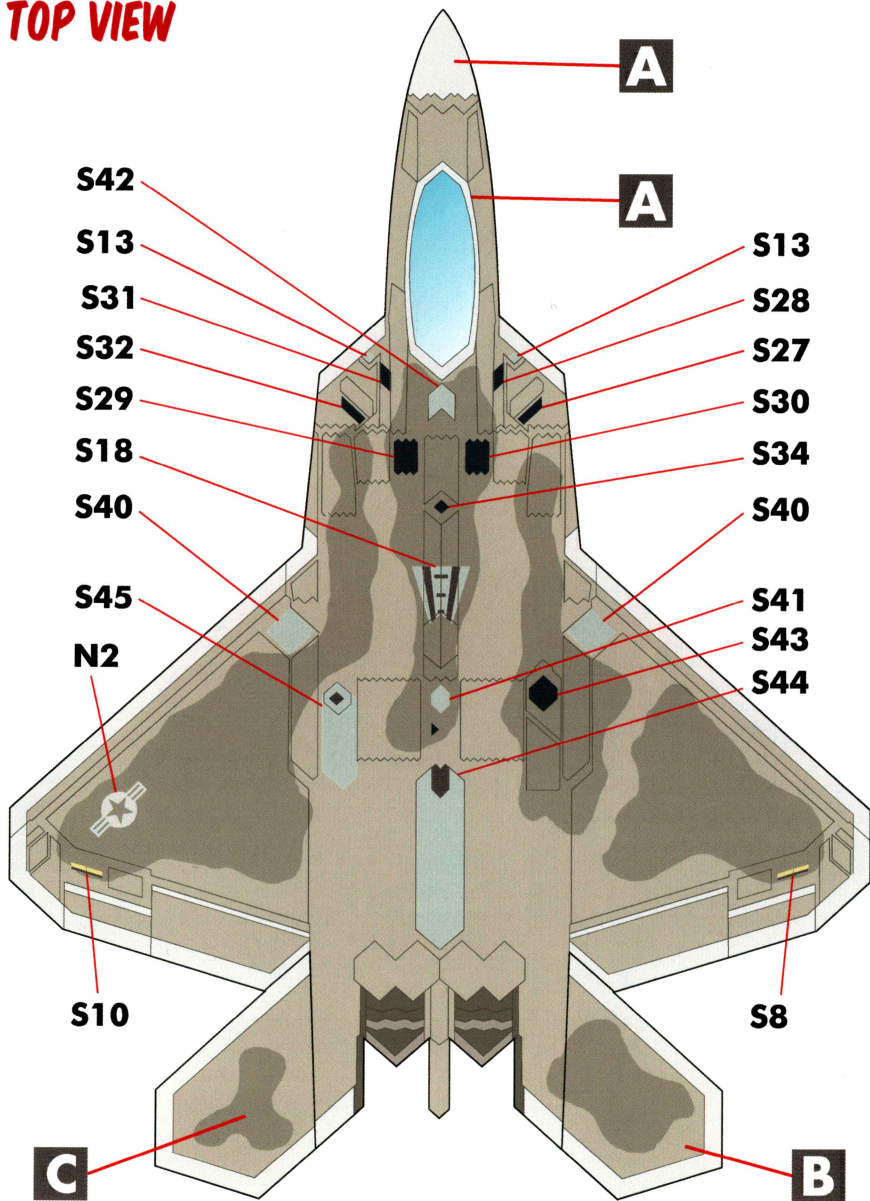

# BOTTOM VIEW

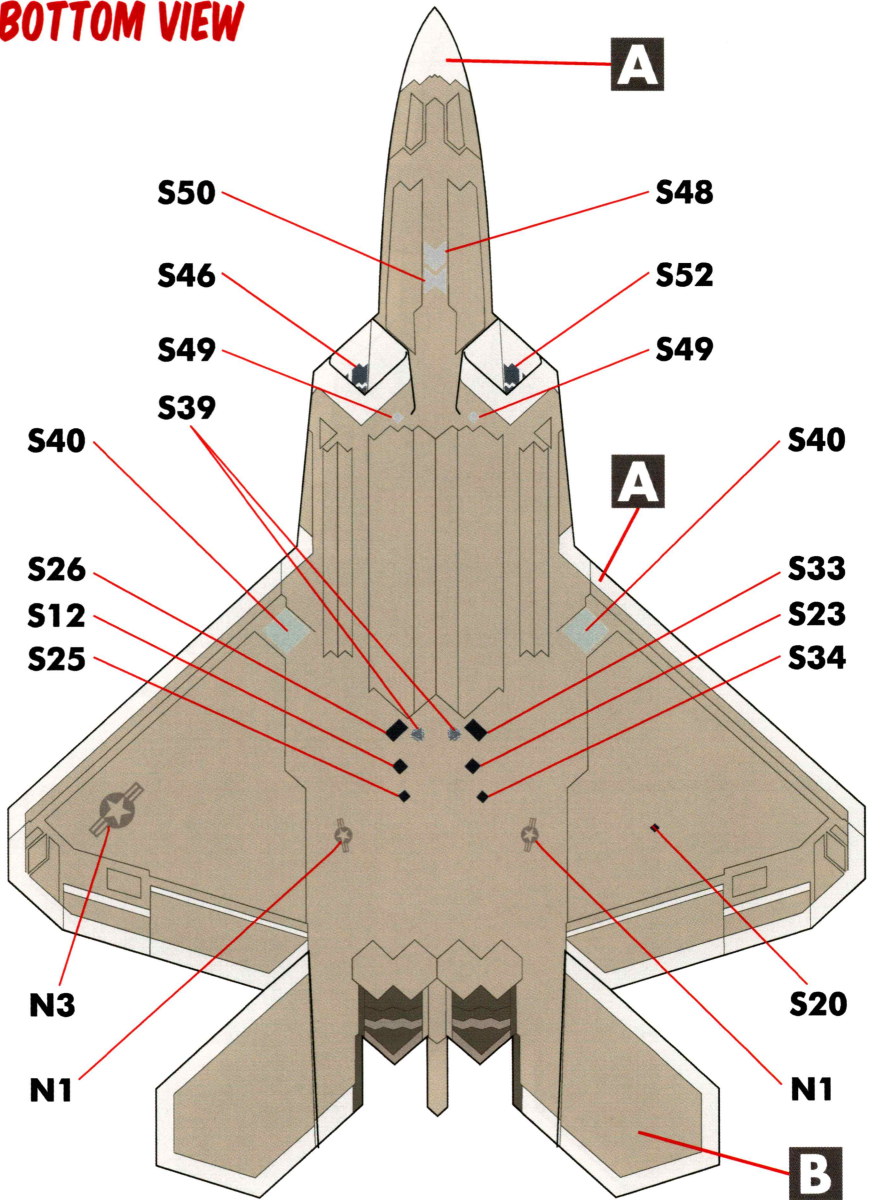

VISIT THE REFERENCE PAGE AT:

[HTTP://WWW.CARACALMODELS.COM/REFERENCES/F22](http://www.caracalmodels.com/references/f22)

- A** LIGHT GHOST GRAY (FS36375)
- B** MOD EAGLE LIGHT GRAY (FS36251)(\*)
- C** MOD EAGLE DARK GRAY (FS36176)(\*)
- D** FRENCH BLUE (FS15180)

(\*) WHILE THESE ARE THE OFFICIAL COLORS, THE F-22 PAINT HAS A METALLIC SHEEN DUE TO ITS RADAR ABSORBENT PROPERTIES.

Caracal Models  
 PO Box 92141  
 Austin, TX 78709  
[info@caracalmodels.com](mailto:info@caracalmodels.com)  
<http://www.caracalmodels.com>

Decals printed by Cartograf in Italy