

eduard
Express Mask

XS 100

Spitfire Mk.I

The die-cut mask for accurate canopy frame painting of the
Tamiya 1/72 KIT

LIQUID MASK

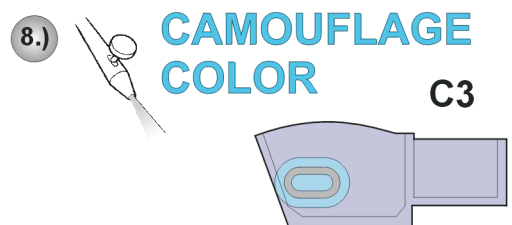
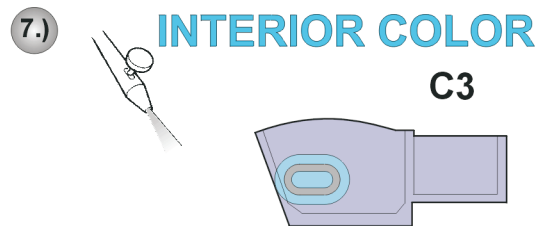
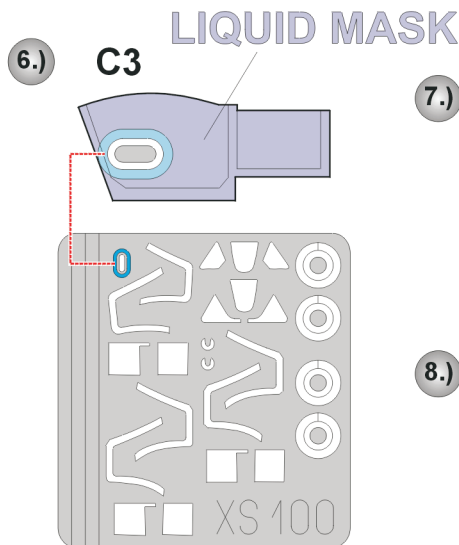
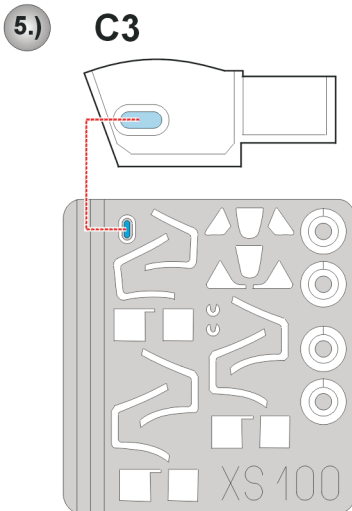
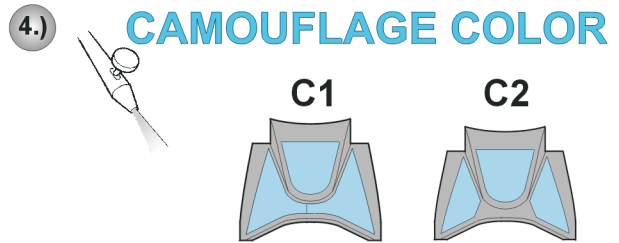
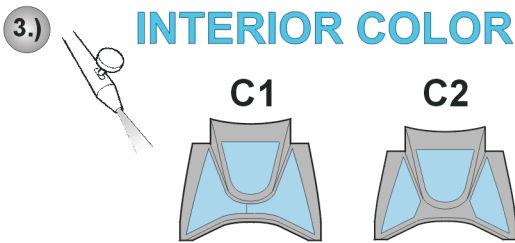
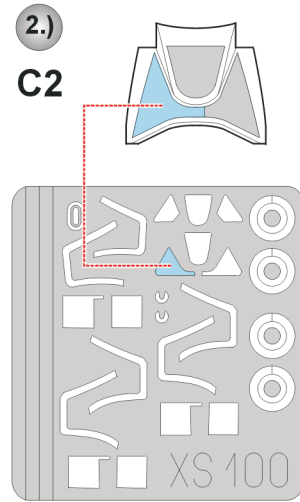
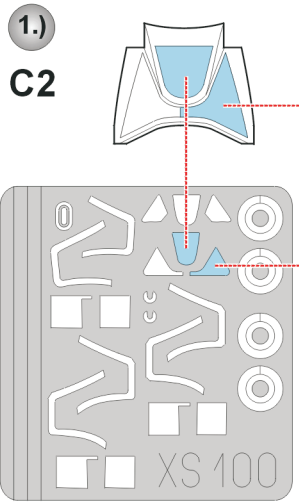
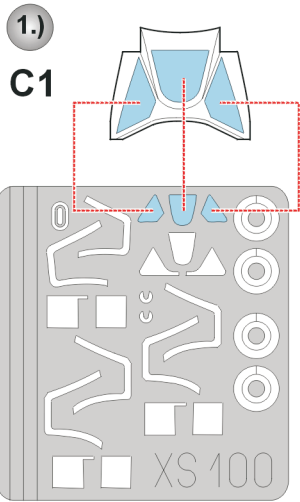
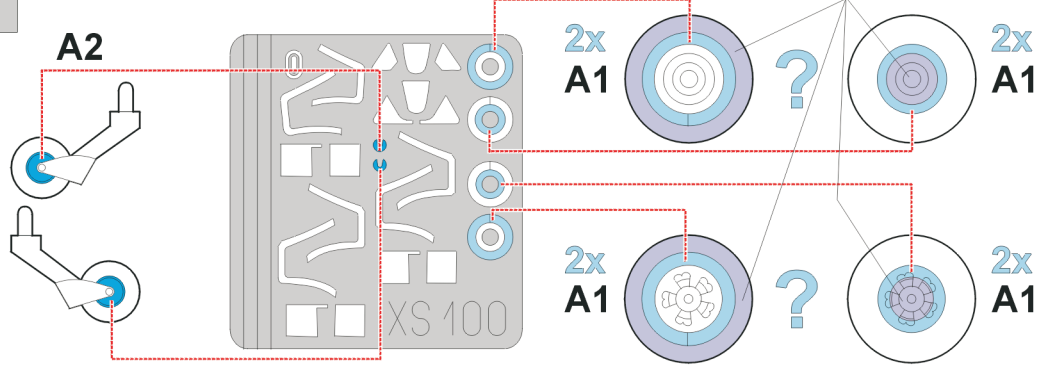

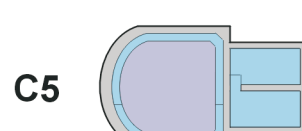
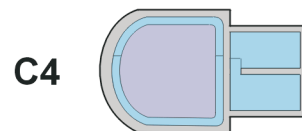
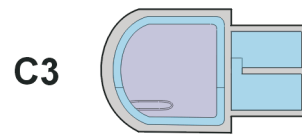
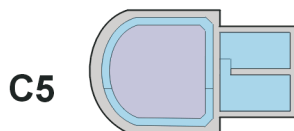
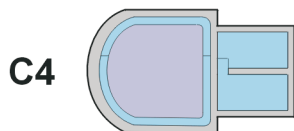
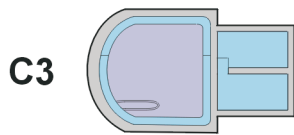
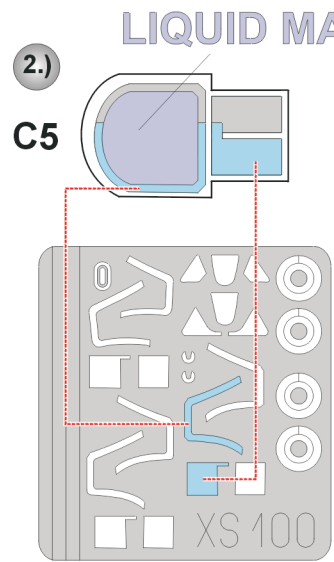
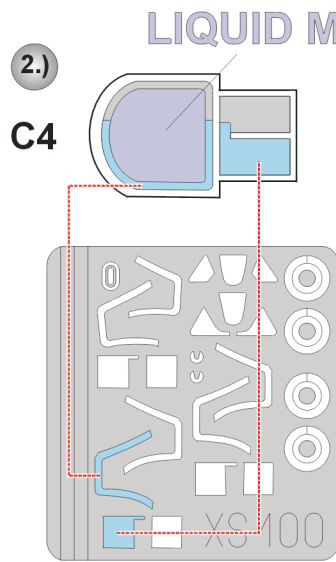
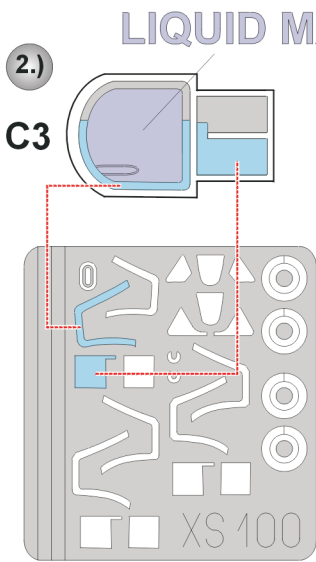
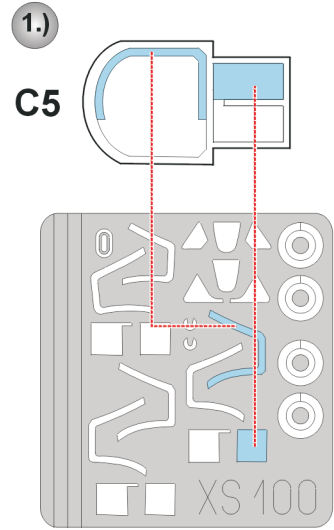
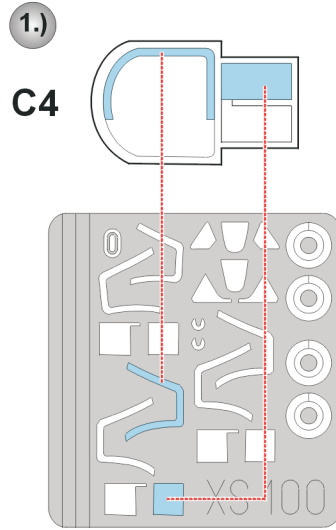
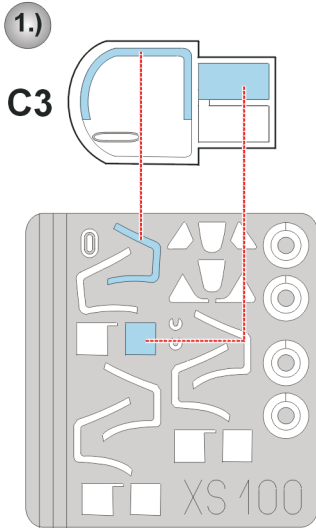

REFERENCES: Replic #67