

Fenders for Panzer I, Ausf.A & B

(Błotniki do Panzer I, Ausf.A i B)

1/35 scale update for Italeri & Zvezda models

ABER 35 A63

Use Cyanoacryl glue (kleić klejami cyjanoakrylowymi)

Made in Poland ©1999

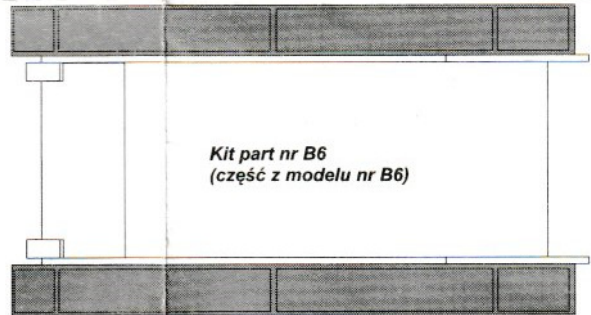
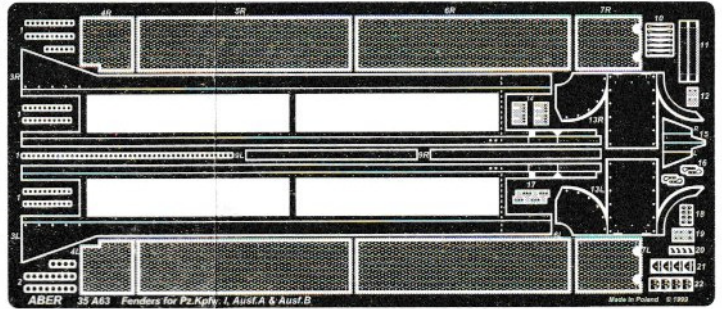
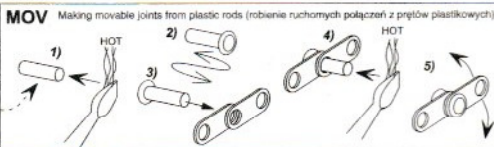
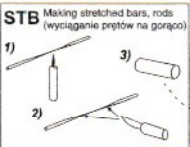
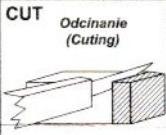

Kit part nr B6 (część z modelu nr B6)

Cut (odciąć)

PRS

F

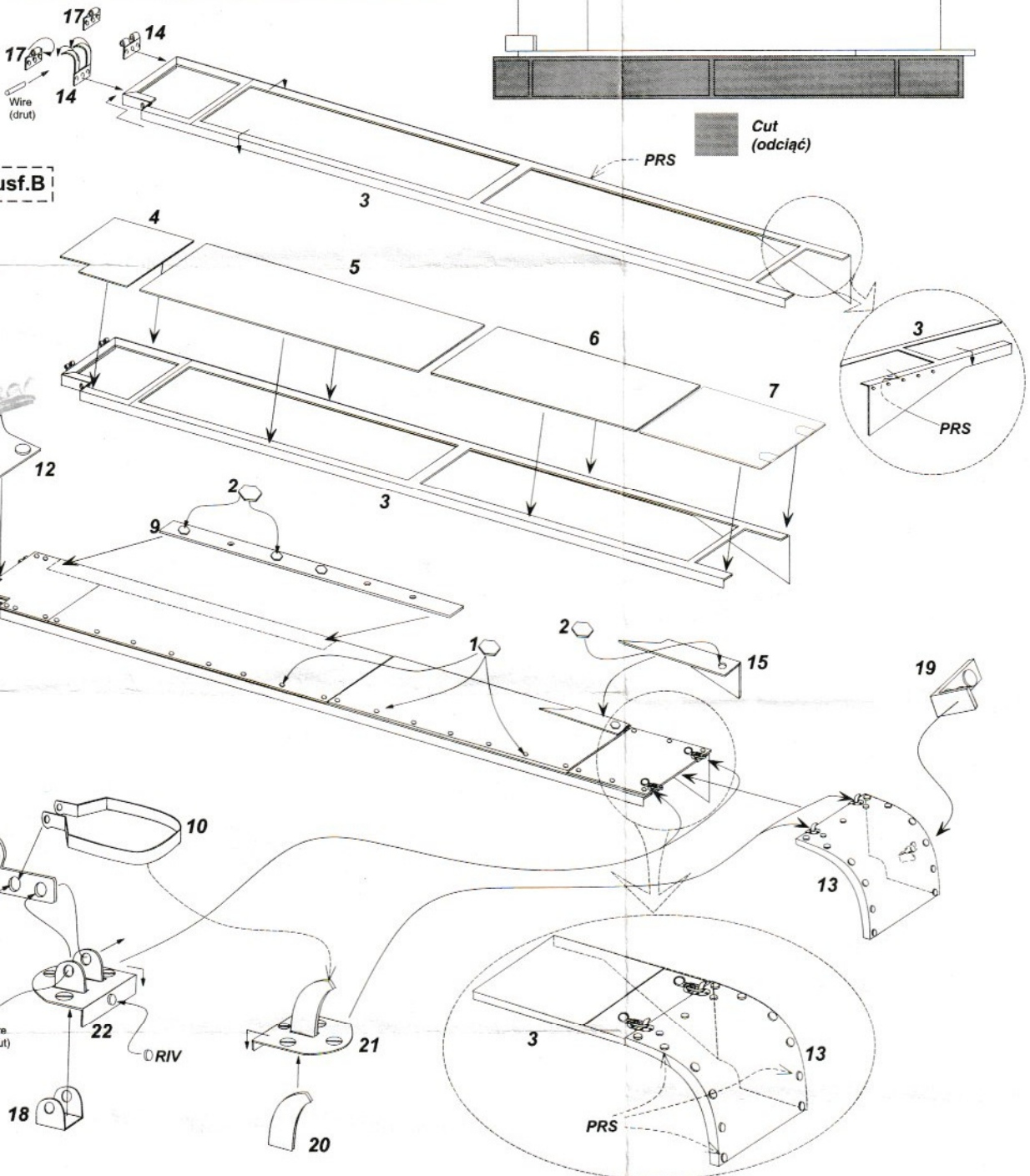

Fenders for Ausf.B

L, R as viewed from rear

Reworked kit part no B 6 (ITALERI-ZWEZDA)
 or Historic HaPM Ltd. part no A 8
 Przerobiona część z modelu nr 6 (ITALERI-ZWEZDA)
 lub Historic HaPM Ltd. część nr A8

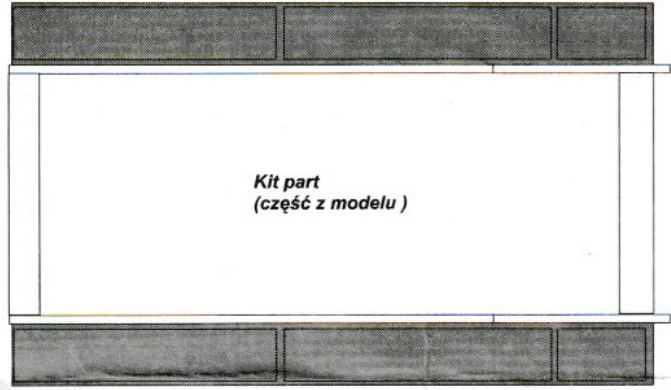

 Cut
 (odciąć)

Fenders for Ausf.A

