



Dodge data plates

1/35 scale detail set for **ITALERI, BÍLEK** • sada detailů pro model **ITALERI, BÍLEK** 1/35

eduard

TP 506

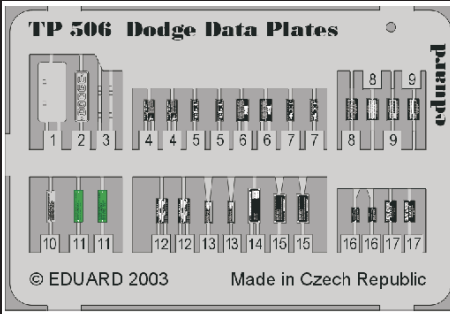

- APPLY EXPRESS MASK AND PAINT BEFORE GLUING
POUŤ IT EXPRESS MASK NABARVIT PŘED SLEPENÍM
- SYMMETRICAL ASSEMBLY
SYMETRICKÁ MONTÁŽ
- REMOVE
ODSTRANIT
- GRIND
OBROUSIT
- DRILL HOLE
VRTAT OTVOR
- BEND
OHNOUT
- OPTION
VOLBA
- REPLACE
NAHRADIT

- ORIGINAL KIT PARTS
PŮVODNÍ DÍLY STAVEBNICE
- PHOTO-ETCHED PARTS
LEPTANÉ DÍLY
- PARTS TO BE REMOVED
DÍLY K ODSTRANĚNÍ
- FILL
TMELIT

Dodge WC-54 Ambulance

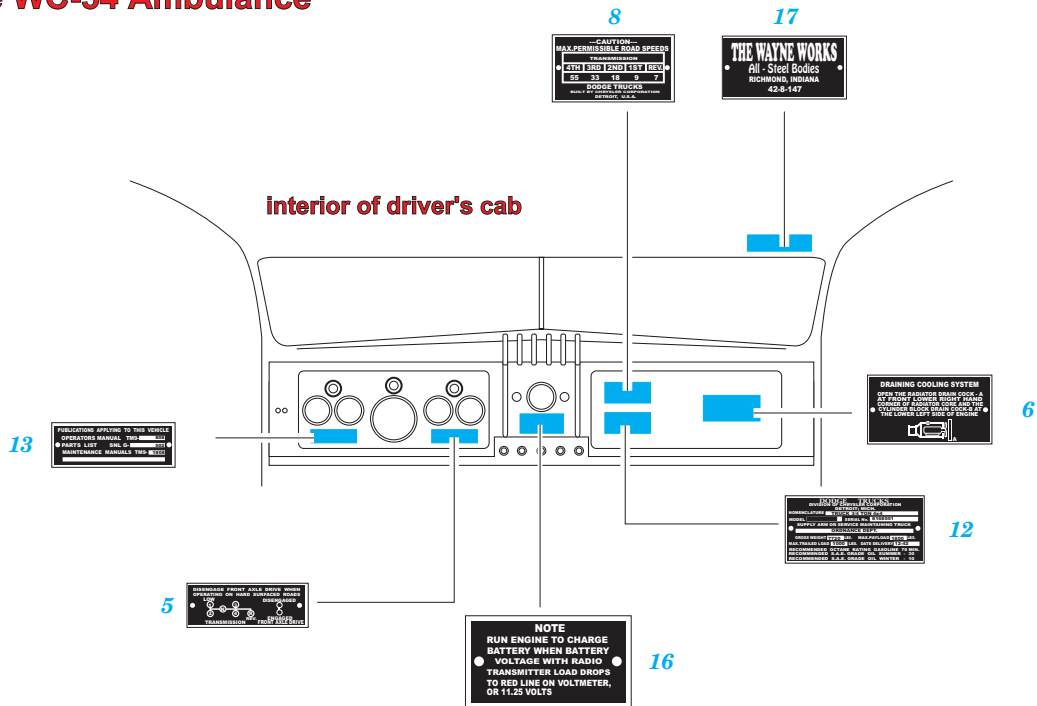

Dodge WC-51,52

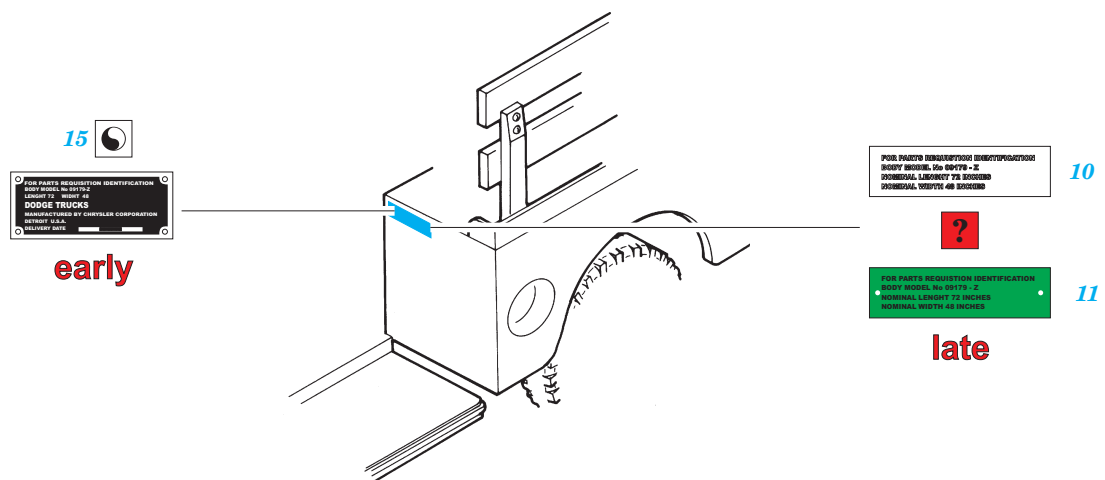

Dodge 4x4 WC-51 early, 52 early, 56, 57, 59, 60, 61

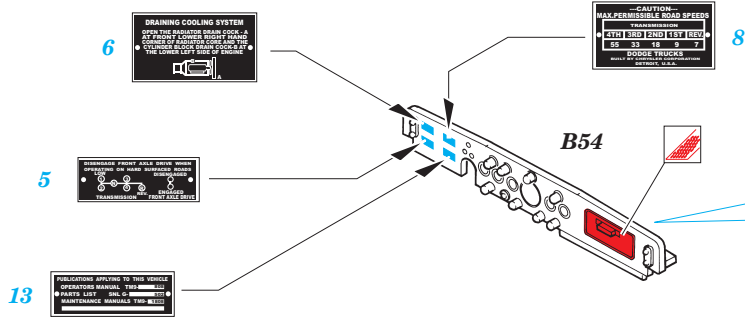

WC-52 early, 57 (with winch)

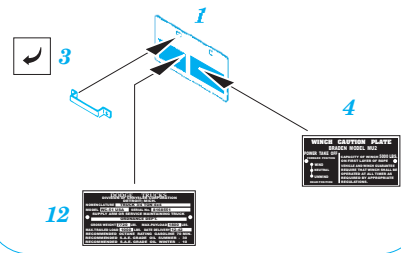

Dodge 4x4 WC-51, 52 late (1944-45)

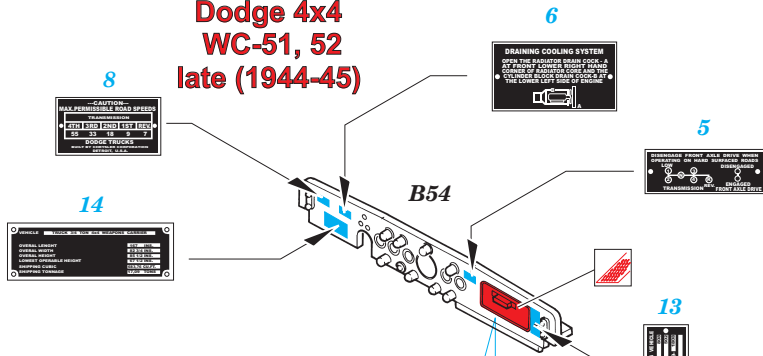

WC-51 early, 56, 59, 60, 61 (without winch)

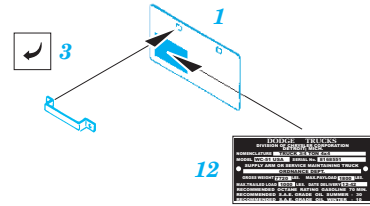

WC-52 (with winch)

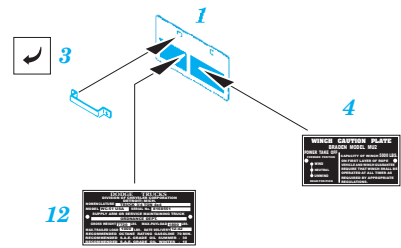

WC-51 (without winch)

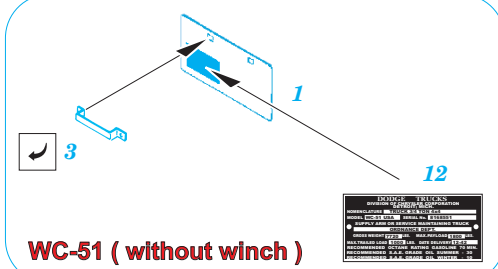

Dodge 6x6 WC-62 WC-63

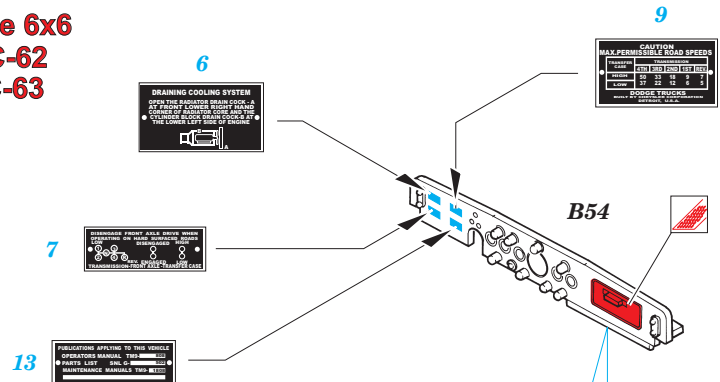
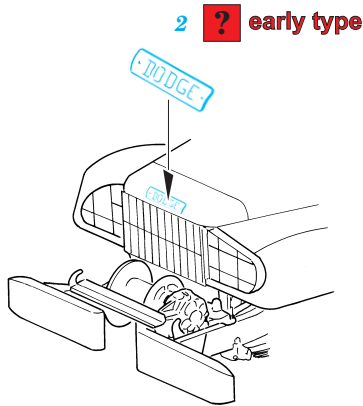

WC-62 (without winch)

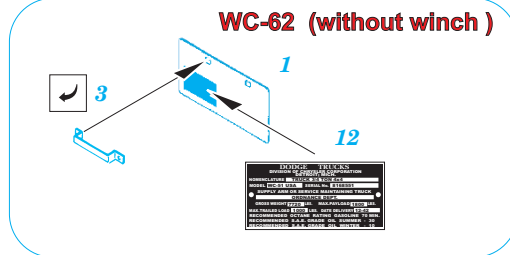

WC-63 (with winch)

