

**eduard**  
**MASK**

**EX 432**

# F-101A/C 1/48

The die-cut mask for accurate canopy frame painting of the *Kitty Hawk KH80115* scale 1/48 KIT

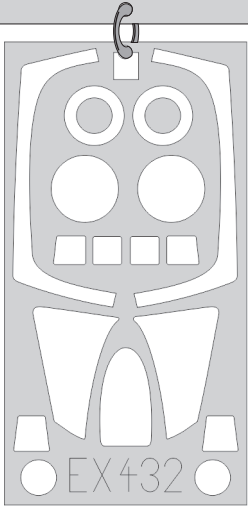

LIQUID MASK

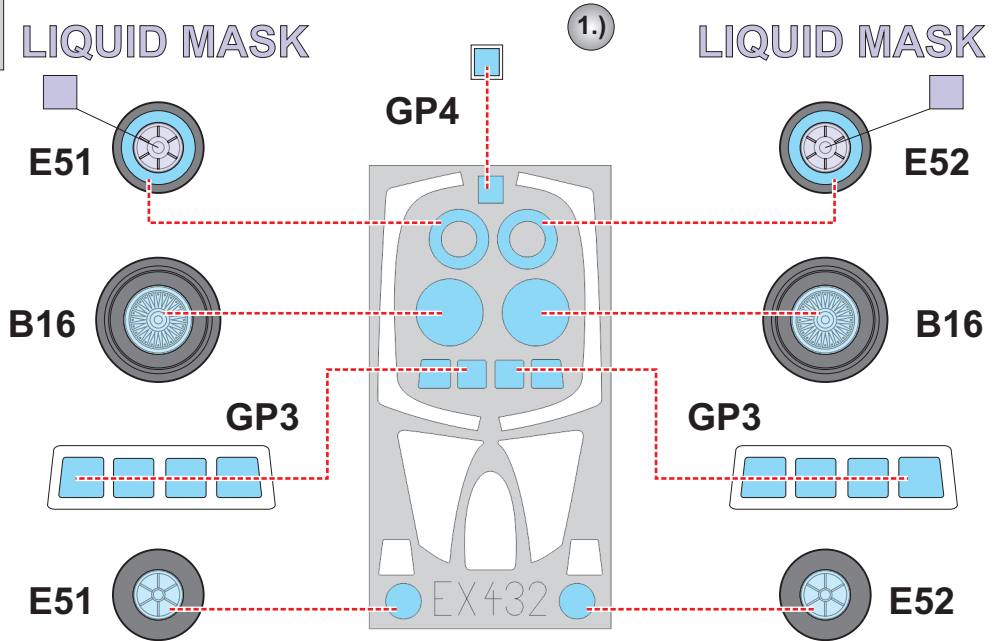

1.)

LIQUID MASK

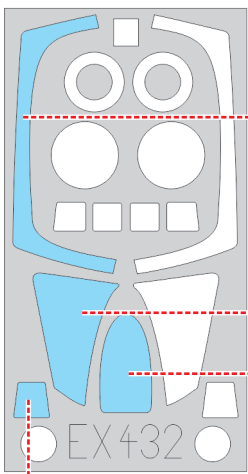

2.)

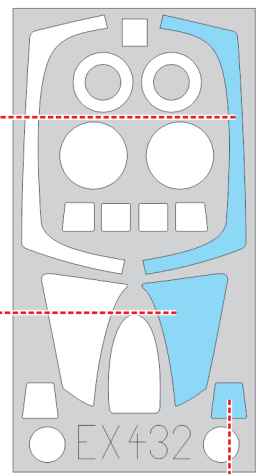
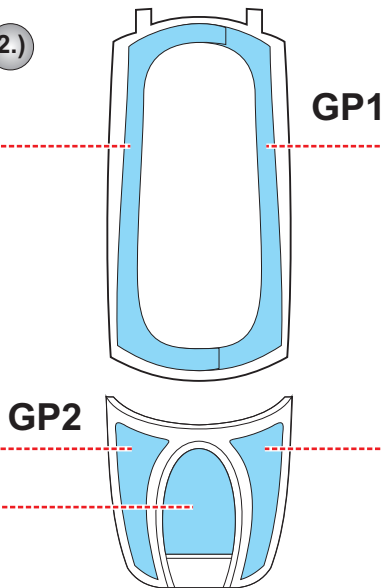

GP5

3.)

LIQUID MASK

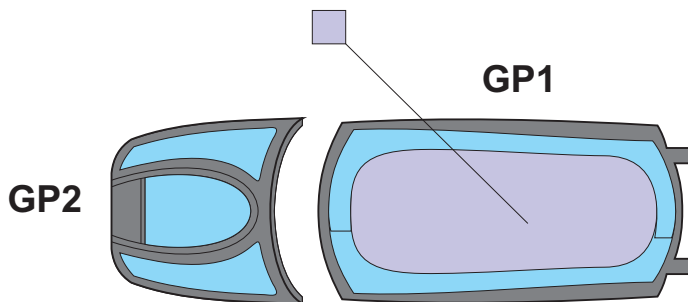

4.)

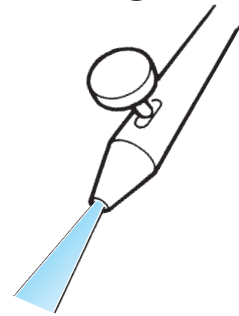

GP5