



Alley Cat is a brand of A2Zee Models

Supermarine Spitfire Prototype

Multi-Media Model Kit ACRK48-19

1. This kit has been designed with the modeler in mind and although not an ideal model for the novice, this model should be well suited to those modelers wanting to try a resin kit.
2. Please study the instructions carefully and prepare the parts with care. To remove the parts from casting blocks and or to remove casting flash from the resin parts (grey or clear) use a good razor saw or a sharp new scalpel.
3. This kit should pose no real problems for assembly once the parts have been prepared, consult the drawings included.
4. This particular Spitfire has caused many debates over the years especially the colours, what was fitted how and when. Hopefully we have covered as many bases as possible and would encourage all to do their own research and to finish the model how they wish in respect to colours used internally and externally. The canopies can be removed from casting stubs with careful use of a saw or sharp knife, and the edges can be filed carefully. The canopies will be enhanced if you dip them in 'FUTURE'.

General

Please wash all parts in warm soapy water. Any parts that would benefit from slight straightening or small adjustments to the shape can be placed in HOT running tap water and with care the modeler can reshape the part.

Resin parts only glue with super glues or epoxy glue. A mask should be worn when sanding resin parts.

To fill resin use "Super Glue" or "Milliput", as these are better fillers to use with resin products. Avoid using styrene fillers, such as "Green Stuff".

Should you have any problems with the product or instructions, please feel free to contact us at the address below.

Thank you for supporting us by purchasing this product. We reserve the right to improve the quality of our products. If you have any comments or suggestions we would appreciate hearing from you.

This kit is intended for modelers with some modeling experience and is not suitable for children. There are sufficient parts to complete one model.

**Contact : A2zee Models Tel : 01506 416 444 Email : sales @a2zeemodels.co.uk
Web : www.a2zeemodels.co.uk**

Supermarine Type 300 Spitfire Prototype

ACRK48-19

Construct cockpit sub-assembly, affix within fuselage then mate fuselage to wings

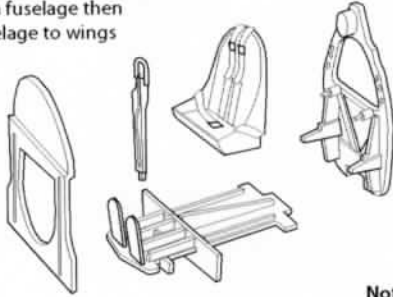

Note option for front cockpit screen

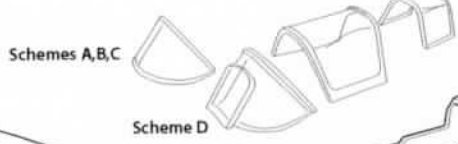

Rudder for Scheme A
 Cut fin to suit if using this rudder type

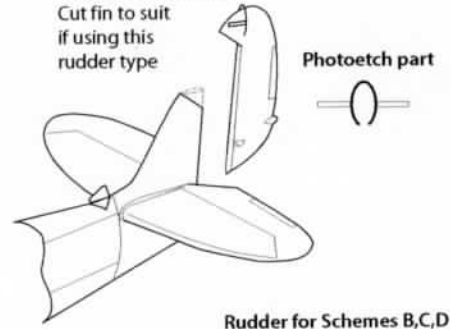

Rudder for Schemes B,C,D

Photoetch parts
 Fold square across points to create a saddle

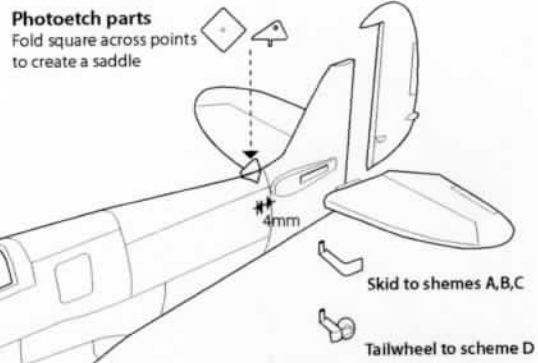

Gun ports.

Reference indicates that the gun ports appered both open and covered on all variants at different times. Modellers should use their own reference when depicting their chosen aircraft.

Scheme D

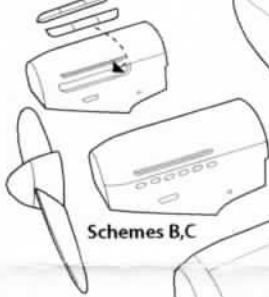

Schemes B,C



Scheme A

Engine cowling options

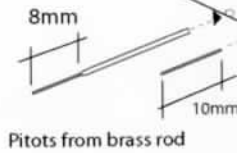

Pitots from brass rod

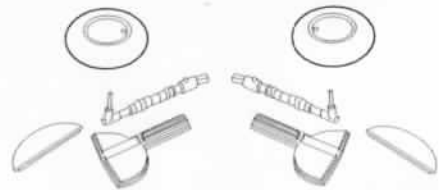
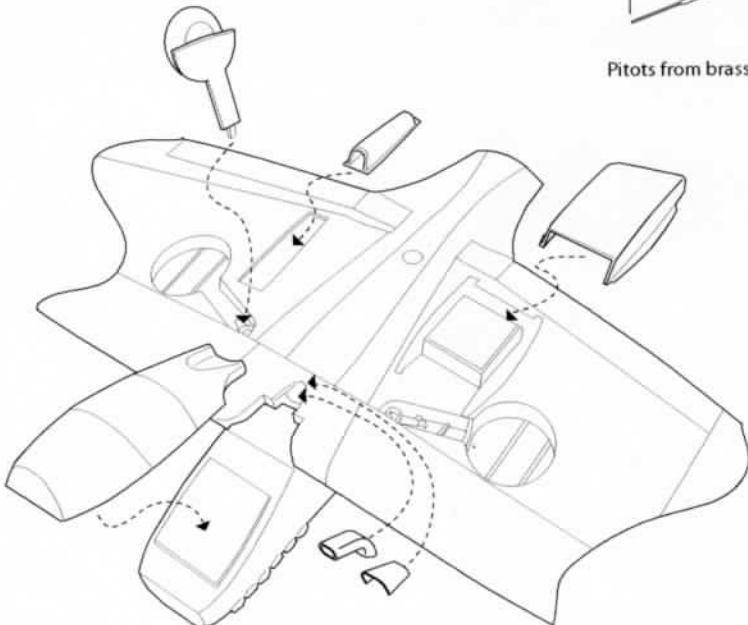

Undercarriage door options

Scheme A - no doors
 Scheme B & C both doors [half moon sits at 90° to main door]
 Scheme D - Main undercarriage door only

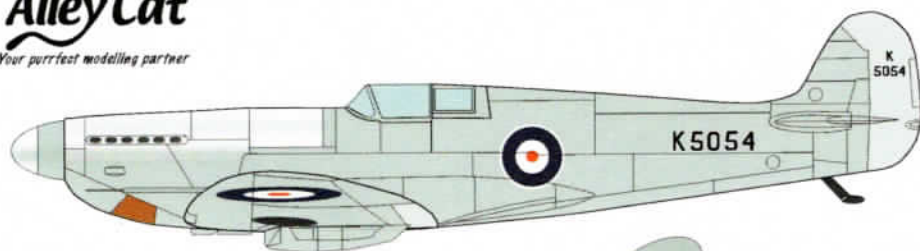

Scheme A
K5054, Eastleigh Airport, 05 March 1936

Overall Natural metal with Yellow/Green zinc chromate primer finish to all metal panels. Brightly polished cowling section. Aluminium Dope to fabric flying surfaces.

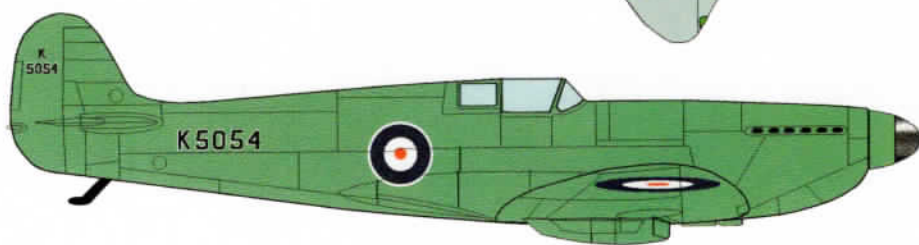
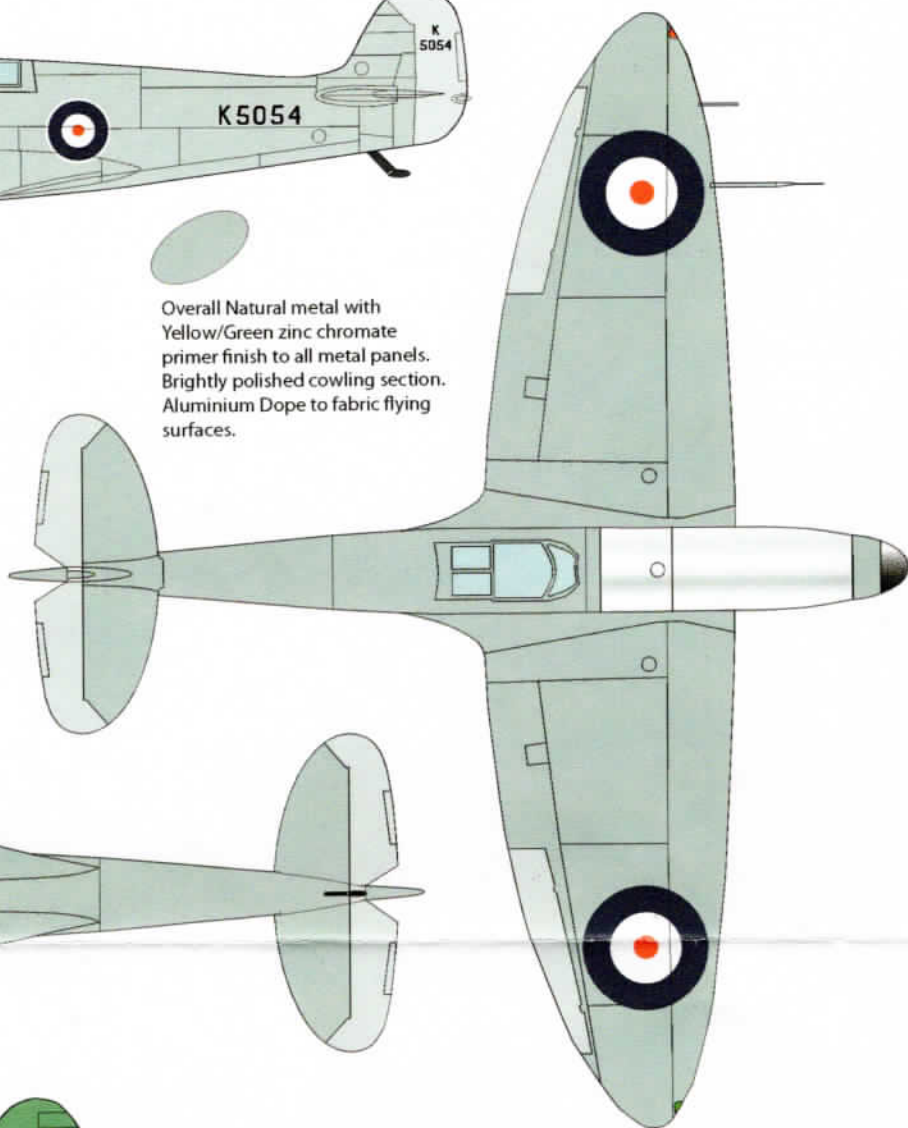
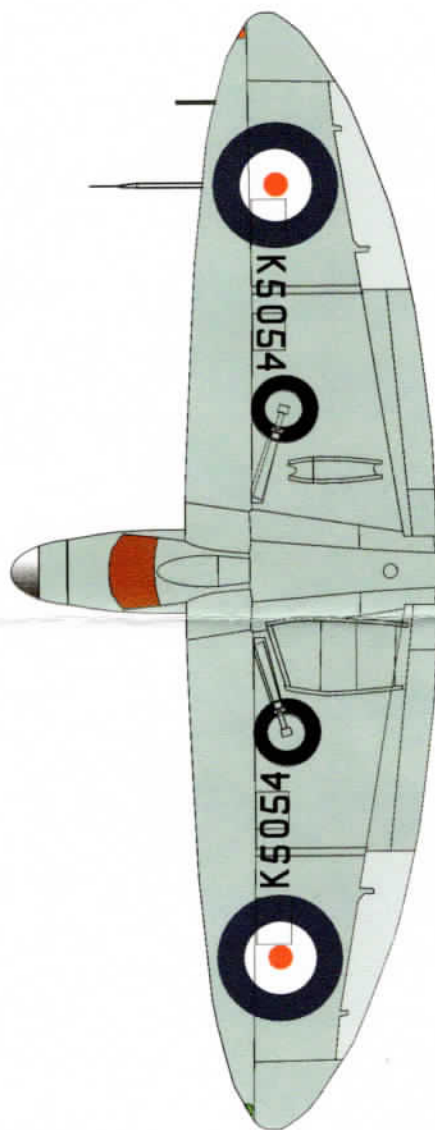

Scheme B K5054, Supermarine Works, Eastleigh, May 1936



Scheme C K5045, Hendon, RAF Pageant, June 1936

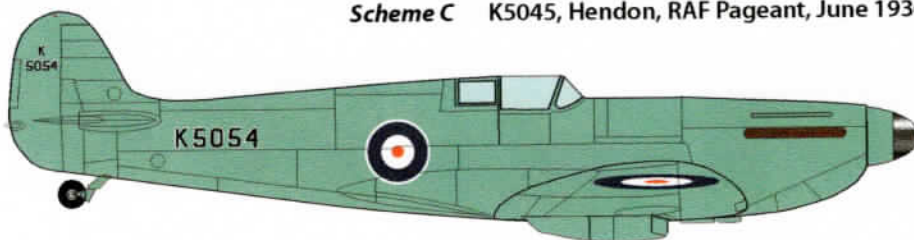

Scheme D K5045, Supermarine Works, Eastleigh, December 1936

 High Gloss Blue Green
Closest matches are-
BS381c Sky Blue
FS 34325

 High Gloss Light Blue-Grey
called "French Grey"
Closest mix - slightly lighter
than FS 35414 + more grey

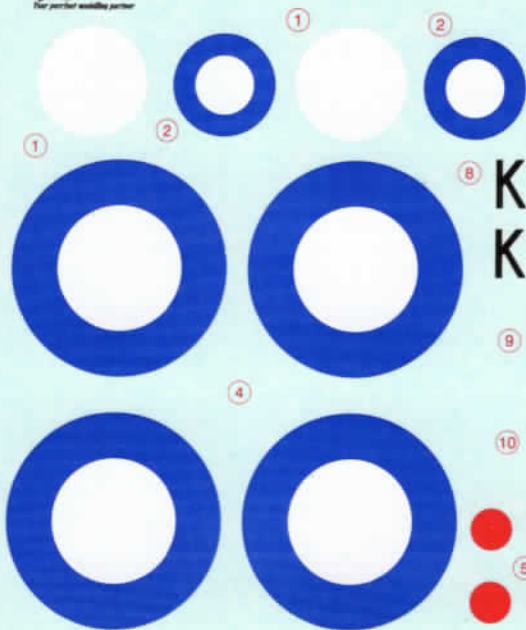

● K ●
5054 5054
● 3 ●
K K
5054 5054

8 K 5 0 5 4
K 5 0 5 4
K 5 0 5 4
9 K 5 0 5 4
K 5 0 5 4
K 5 0 5 4
10 K 5 0 5 4
K 5 0 5 4

● ● ● ●
5 ● ●
11 22

OUTSIDE



INSIDE

