



READ BEFORE ASSEMBLY:

- Study and understand these instructions thoroughly before beginning assembly
- When needed, remove photo-etch parts carefully using a modeling knife or photo etch sprue cutter, being careful not to damage or lose small parts.
- Take extra care in handling photo etch parts in order to avoid injury
- Apply instant cement sparingly to photo etch parts where instructed
- Tools recommended(not included in kit):Plastic and instant cements,sprue cutters,long nose pliers,,modeling knife, small files, tweezers, pin vise & scissors. Soft cloth and sandpaper will also assist in construction
- Glue and paint are not included in the kit. Use plastic cement and hobby paints only. Color guide for purchasing paint is included in the kit.

装配之前仔细阅读

- 小心用模型锉刀锉平所有零件表面的注射浇口。
- 小心用刀片切下蚀刻片零件，不要遗失小零件。
- 用强力快干胶水粘合蚀刻片零件和金属轴。过量的快干胶水使用可能导致可动零件会粘住，小心涂胶。
- 取蚀刻片时应特别注意安全，防止利边划伤手指。
- 某些零件表面需贴水上贴纸，请选择在装配的同时进行。
- 推荐模型工具(自备)：胶水，水口剪刀，长咀钳，刀片，锉刀，镊子，钳，钻，剪刀，瞬间快干胶。
- 软布同砂纸同时也是所需工具。
- 请使用塑料胶水和油漆，模型内不舍。



使用强力胶

Cyanoacrylate glue



配重

Weight



钻孔

Make hole



切除

Cut / Remove



贴纸

Decal



锉平

File / Sand



选择

Option



不涂胶水

No cement



弯曲

Bend



先装

Install it first



填补

Repair

水贴纸的使用:

1. 从水贴上剪下印花;
2. 将印花放入温水中浸10秒, 然后放在干净布上。
3. 拿着印花纸板将印花移到模型上;
4. 手指蘸水将印花移到适当的位置;
5. 用软布轻压印花直至水干, 气泡消失。

DECAL APPLICATION

1. Cut off decal from sheet.
2. Dip the decal in tepid water 40°C for about 10 sec. and place on a clean cloth.
3. Hold the backing sheet edge and slide decal onto the model.
4. Move decal into position by wetting decal with finger.
5. Press decal gently down with a soft cloth until excess water and air bubbles are gone.
6. Allow decal to dry completely before handling model.

* 说明书中含有重要信息, 应保留。 Please Keep instruction since it contains important information.

部品图 Parts

《车面》
Upper hull

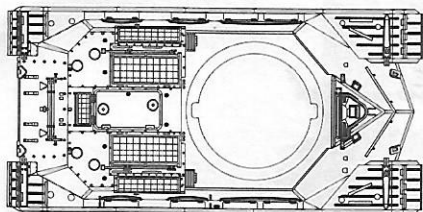

《车底》
Lower hull

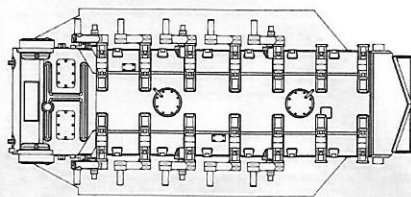

G

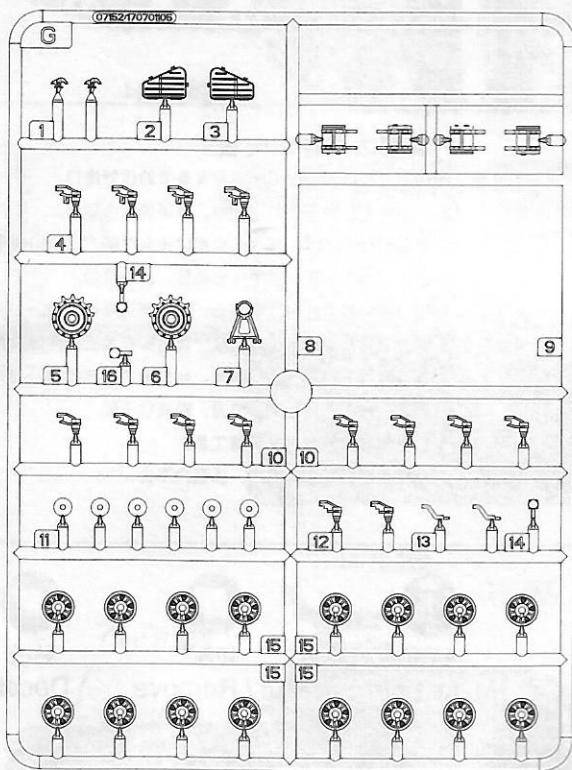

H

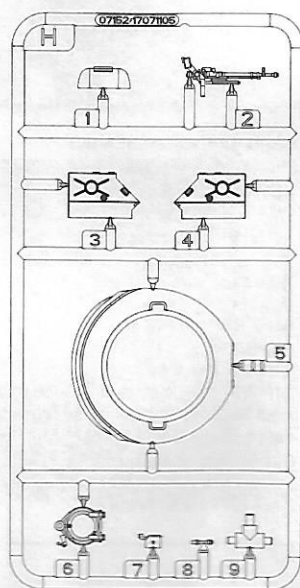

《水贴》
Decal



E

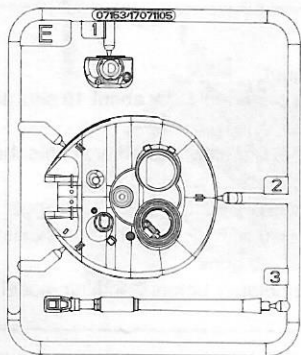

《左侧履带》
Left track



《右侧履带》
Right track



1

《车底》
Lower hull

G5

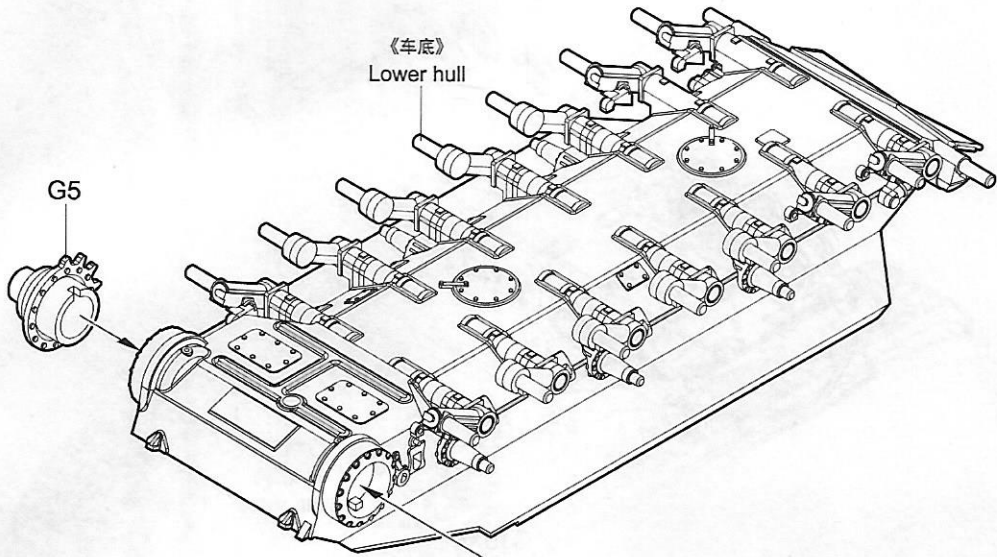

G6

对侧相同
Both sides
G13

G12
对侧相同
Both sides

G10
对侧相同
Both sides

G4
对侧相同
Both sides

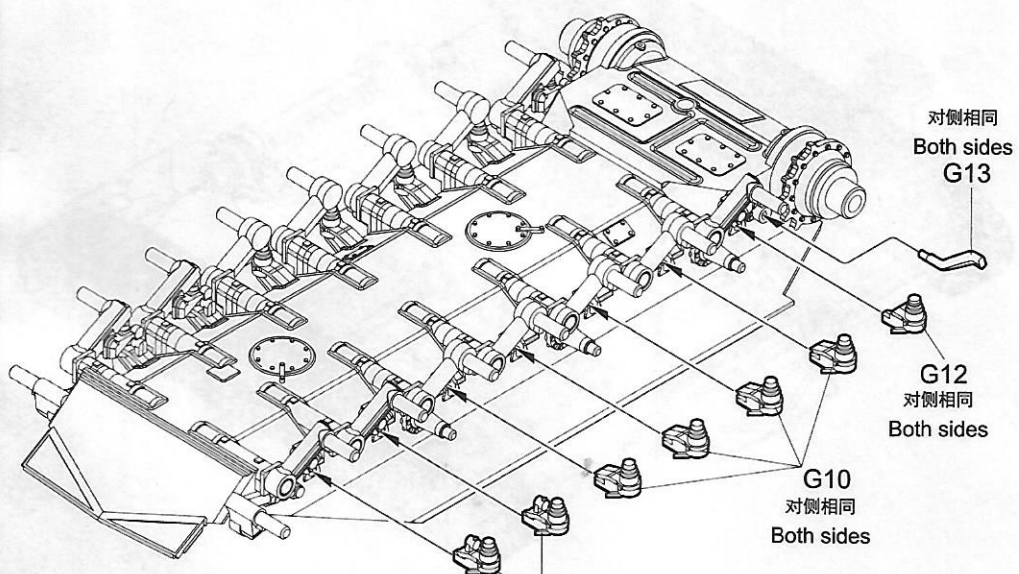

2

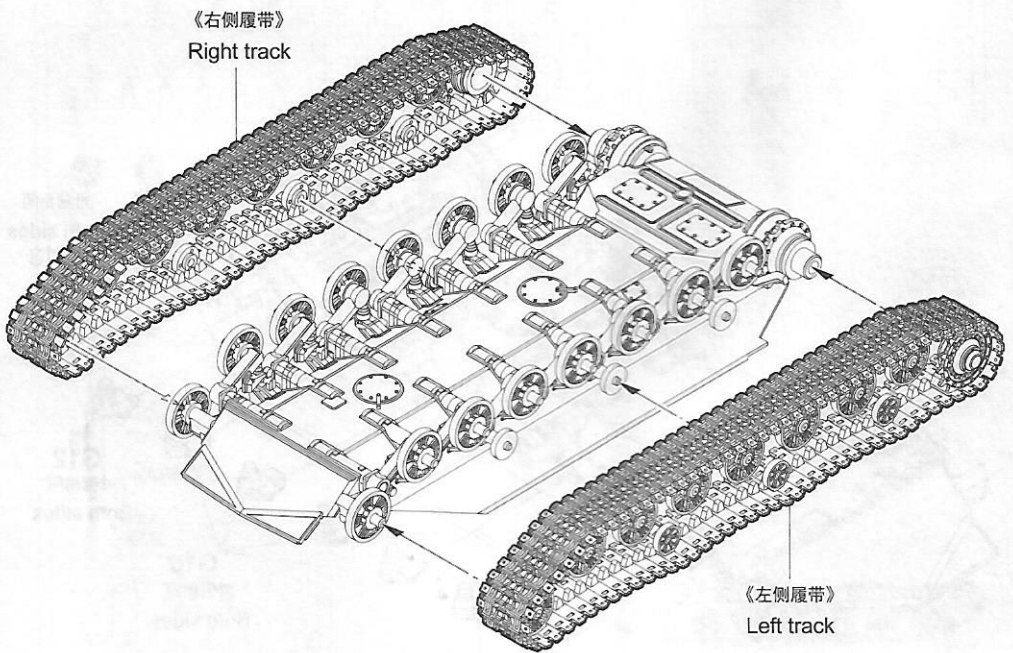
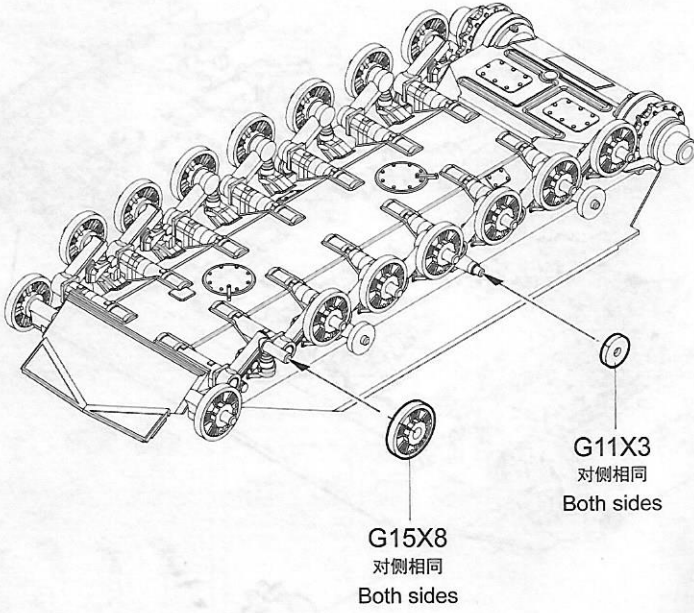

3

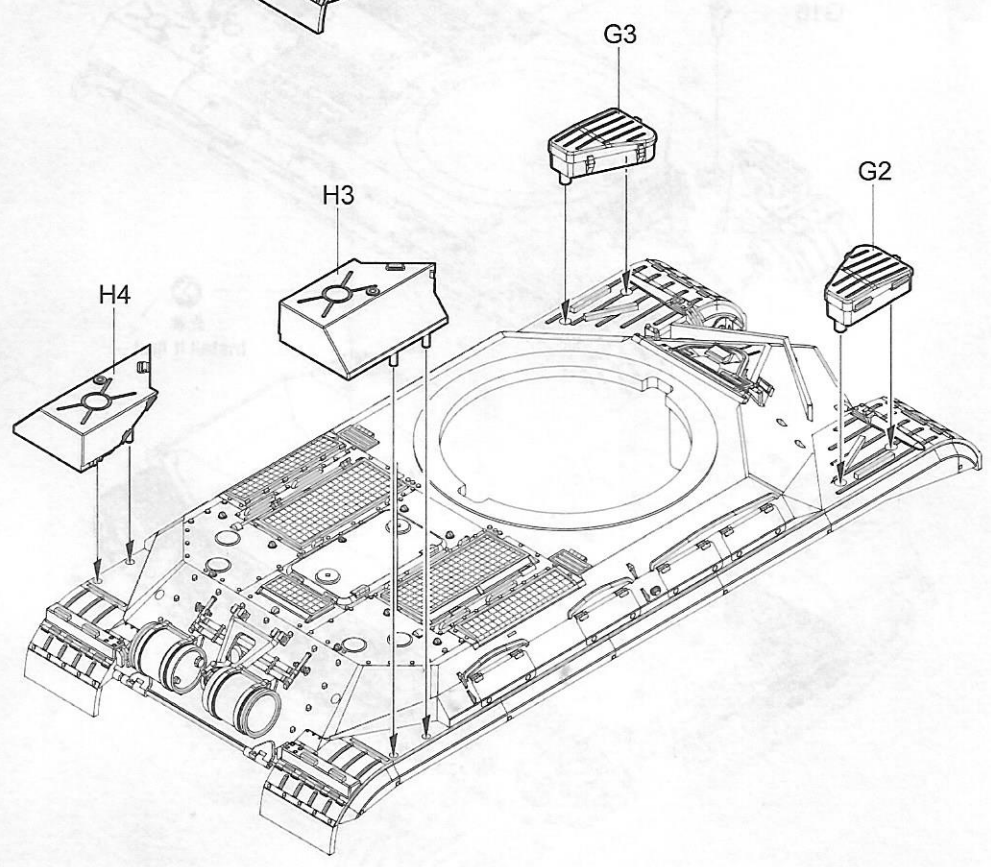
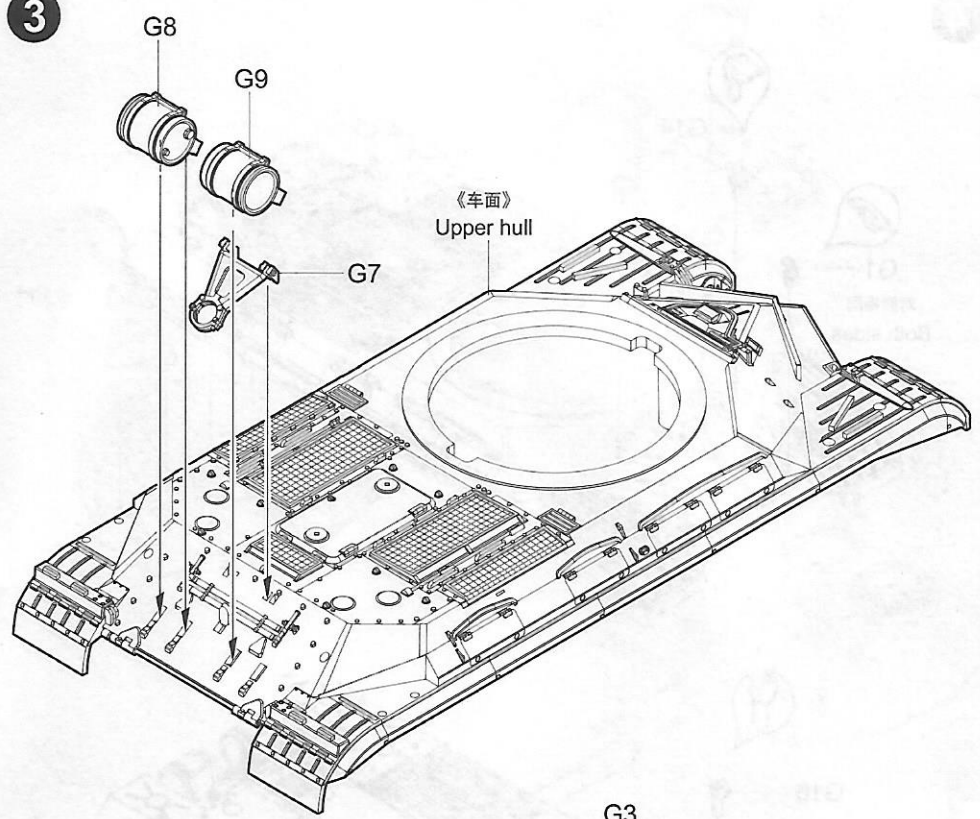

4

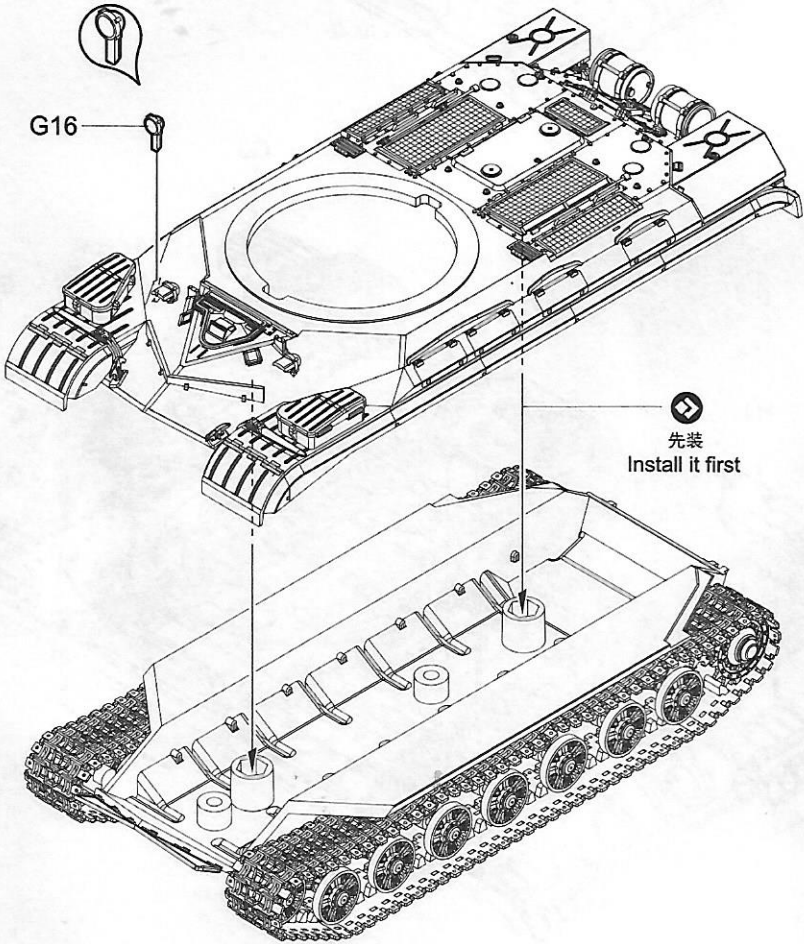
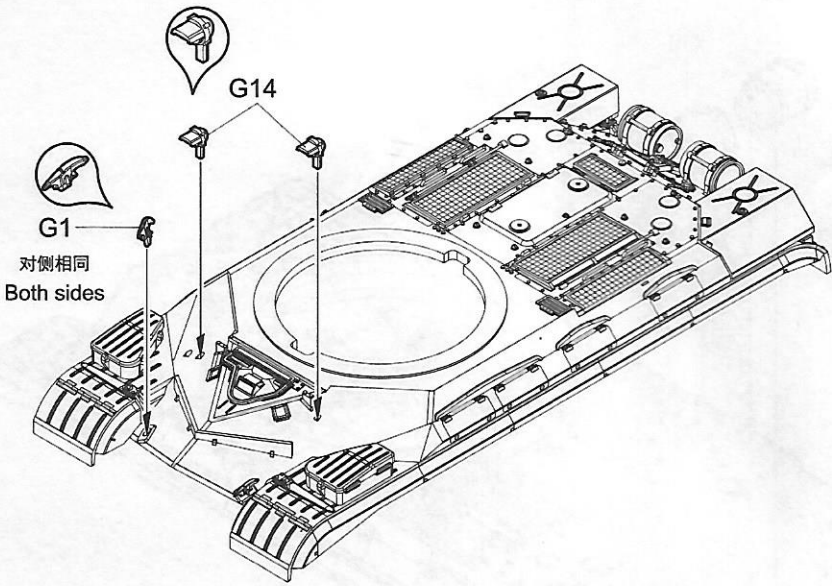

5

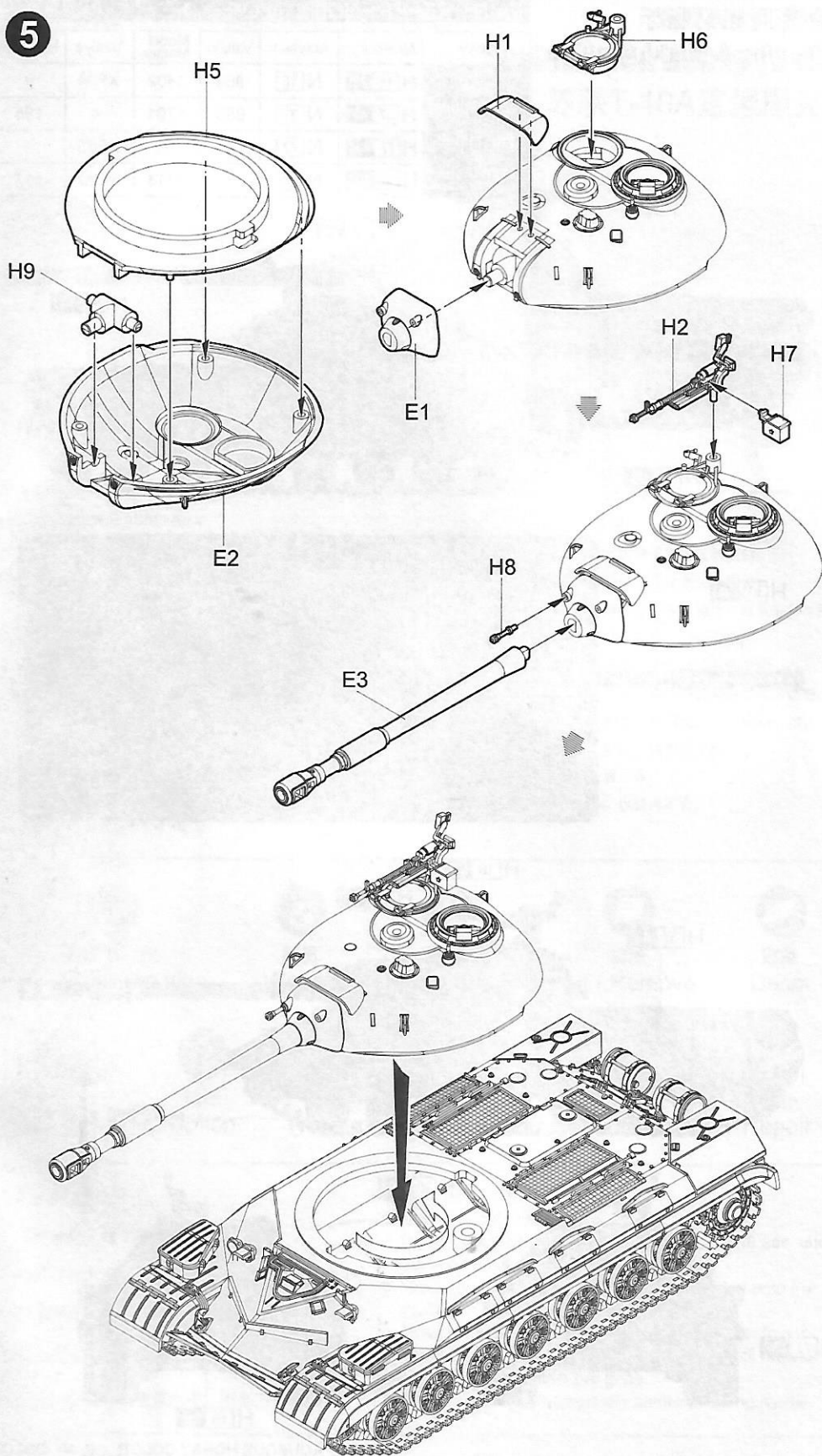

涂装同标贴指示

Painting & Marking guide

PAINT REFERENCE COLOR

Color	Mr.Hobby	Acrycion	Vallejo	Model Master	Tamiya	Humbrol
Steel 钢铁色	H 18 28	N 18	864	1402	XF84	-
Wood Brown 木棕色	H 37 43	N 37	983	1701	-	186
Tire Black 胎黑色	H 77 137	N 77	-	-	XF85	-
Light Green 浅绿色	H 303 303	N 303	-	1713	XF20	117

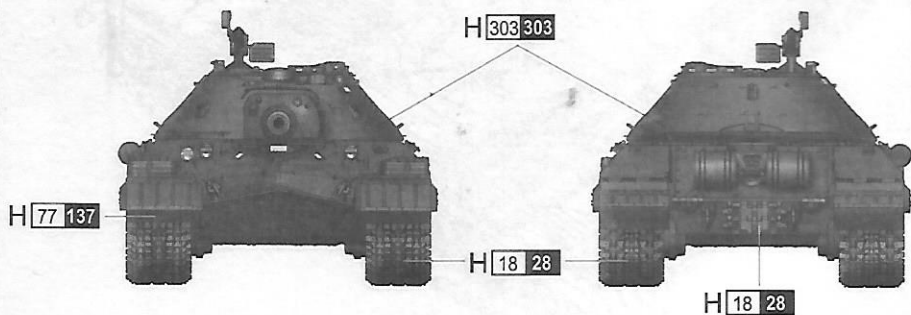
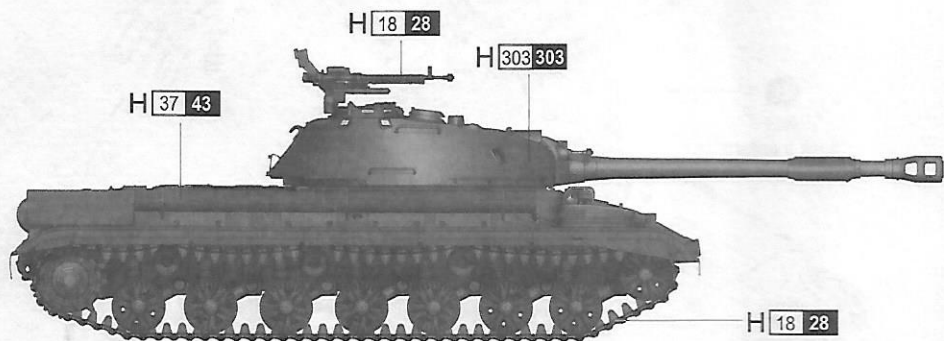

H AQUEOUS HOBBY COLOR Mr. COLOR
N ACRYSION COLOR