



YANNMIE

1/100 SCALE PLASTIC MODEL KIT.

组装说明书 |
ASSEMBLY
INSTRUCTIONS |

There is a certain gap between the packaging picture and the actual product, please refer to the physical model

DEPLOYABLE
MECHANISM

展开机构



■ THORAX



■ SHOULDER



■ ARM



■ CROTCH

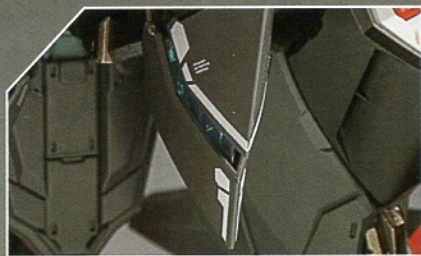

■ KNEE



- 湮灭全身具备丰富的精神力骨架，可通过拉伸展开爆甲形态，透过蓝色透明件使机体更具表现力。
- Annihilation has a rich spiritual force skeleton, which can be stretched to unfold the explosive armor form and make the body more expressive through blue transparent pieces.

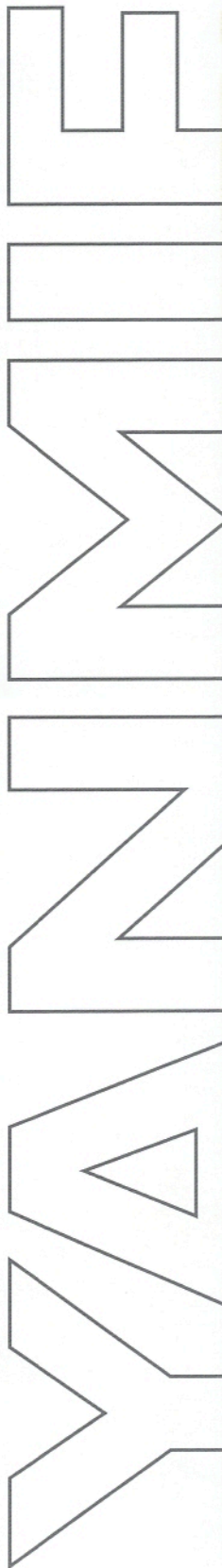

IRON MAN MARK LXXX V

警告 WARNING

- 本品含有小零件，请勿让三岁及以下儿童玩耍，建议使用年龄为15岁以上。
- Small parts are included in this product. The product is designed for children over 15 and is forbidden for those under 3

注意事项 MATTERS NEED ATTENTION

- 清洁请使用干布抹擦干净，对拆除后的包装物，请不要随地丢弃，以免污染环境；
- Cleaning it with a dry cloth. Don't litter away any wrapping materials after removing them to protect environment.

电池安全使用事项 NOTICE FOR USING BATTERIES

- 按正确的方法取出和放入电池；
- 非充电电池不能充电；
- 型号相同或推荐型号等等的电池才可以混用；
- 电池以正确的极性放入；
- 不同类型的电池或新旧电池不能混用；
- 用尽的电池应从玩具中取出；
- 产品LED灯组使用两颗型号为SR521SW 1.55V的纽扣电池；
- The batteries should be removed and installed in the correct way;
- Do not charge non-rechargeable batteries;
- Only the same type and recommended type of battery can be used;
- The batteries should be inserted with the right polarity;
- Do not use different types of batteries or mix old and new batteries;
- The exhausted batteries should be removed from the toy;
- Two button batteries of type SR521SW 1.55V are needed for LED lamp set of the product;

⚠ CAUTION / 注意事项

- 不适合15岁以下儿童使用；
- 组装前请详细阅读说明书；
- 请将零件按编号整齐组装，组装后把边角料丢弃；
- 零配件当中有带尖锐或刺手的，在组装时请小心；
- 请在成人指导下正确使用；
- 建议在涂装粘糊时使用安全的“水性涂料”。
- 含有细小零件，请勿吞食，以免造成窒息；
- 内有尖端物，小心使用请勿刺人，以免造成伤害；
- 为避免产生窒息或其他之危险，请将盒内胶袋销毁。

- Only for children over 15 years old.
- Please read the instructions carefully before assembling.
- Please assemble the parts according to serial number and discard the leftover materials after assembling.
- Please be careful for any sharp parts when assembling.
- Please use it properly under the guidance of an adult.
- It is recommended to use safe "water-based paint" when assembling and gluing parts.
- To avoid any potential risks of suffocation, please don't swallow any small parts contained in the product.
- To avoid causing injury, please be careful and don't use sharp parts to stab people.
- To avoid any potential risks like suffocation, please destroy the plastic bags in the box as soon as possible.

散件清单 PARTS LIST

A PARTS MATERIAL:ABS X2

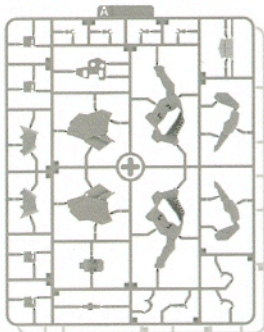

B PARTS MATERIAL:ABS

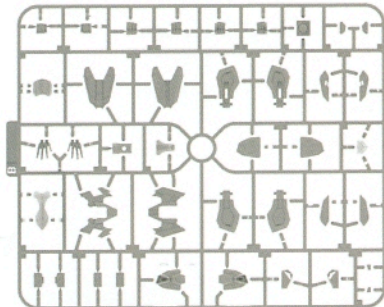

C2 PARTS MATERIAL:ABS X2

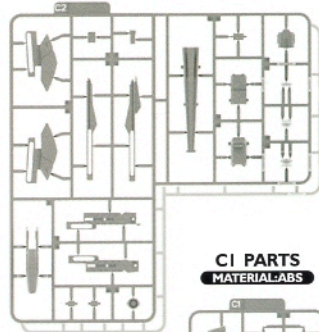

C1 PARTS MATERIAL:ABS

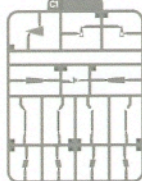

D PARTS MATERIAL:ABS

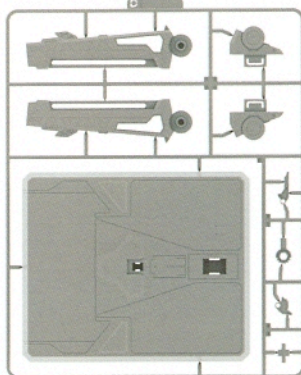

E1 PARTS MATERIAL:ABS X2

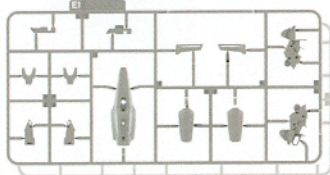

E2 PARTS MATERIAL:ABS

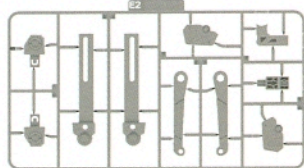

F PARTS MATERIAL:ABS

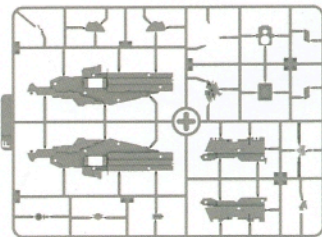

G PARTS MATERIAL:ABS X2

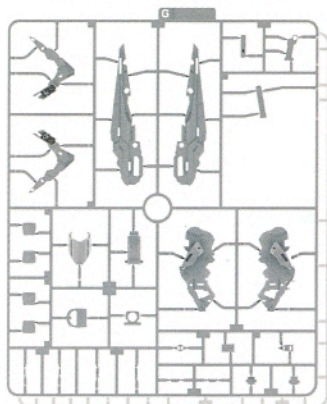

H PARTS MATERIAL:ABS

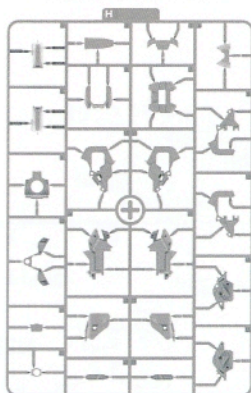

I PARTS MATERIAL:ABS

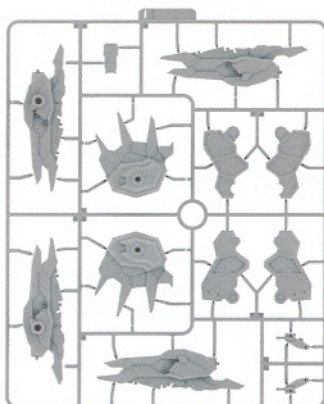

J1 PARTS MATERIAL:ABS

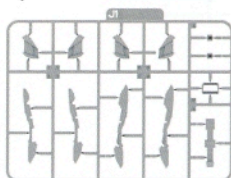

K PARTS MATERIAL:ABS X2

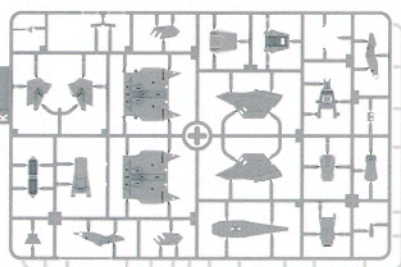

L PARTS MATERIAL:ABS

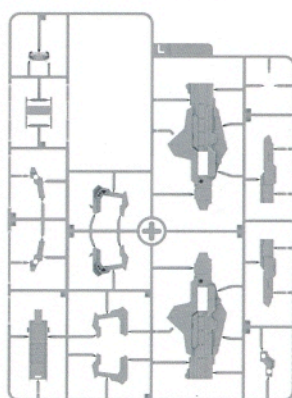

J2 PARTS MATERIAL:ABS X2

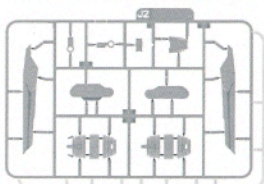

M2 PARTS MATERIAL:ABS X2

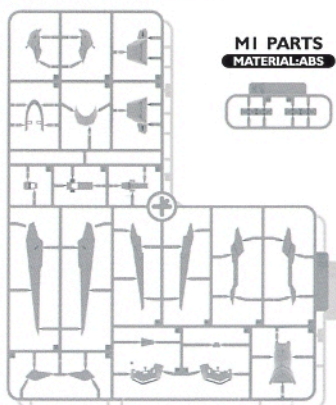

M1 PARTS MATERIAL:ABS



N1 PARTS MATERIAL:ABS

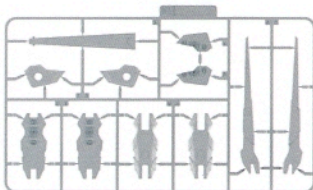

P1 PARTS MATERIAL:ABS

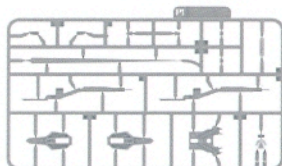

P2 PARTS MATERIAL:ABS



N2 PARTS MATERIAL:ABS X2

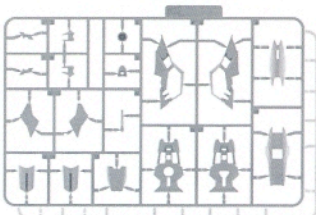

O1 PARTS MATERIAL:ABS X2

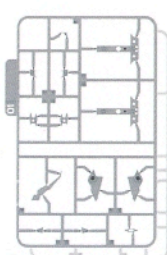

O2 PARTS MATERIAL:ABS X2

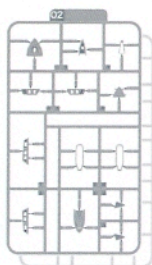

P3 PARTS MATERIAL:ABS X2

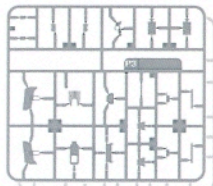

1 [头部组装]

HEAD UNIT

1 1

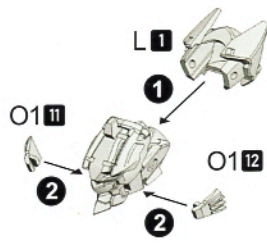
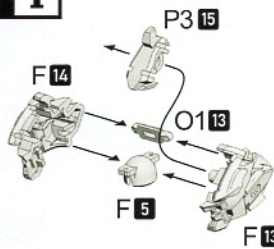

1 2

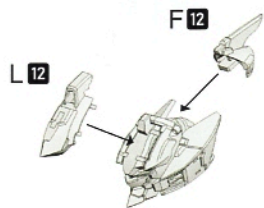
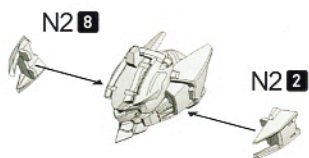
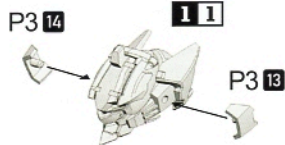

1 3

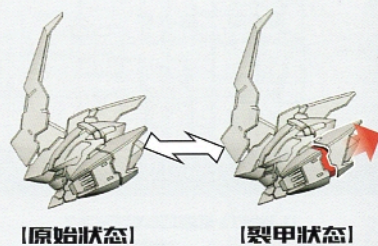
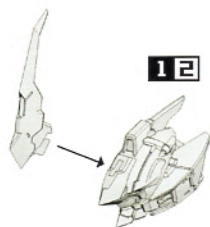
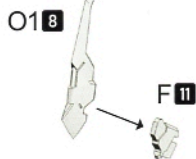

[四肢拆解]

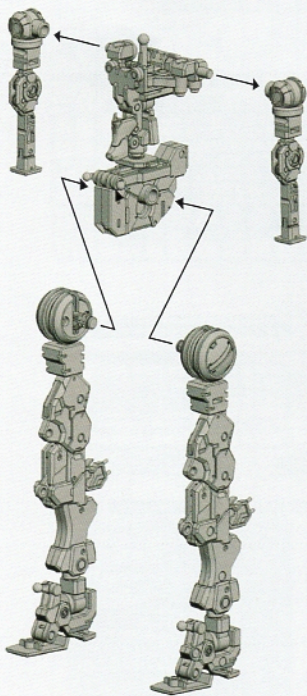

2 [躯干组装]

BODY UNIT

2 1

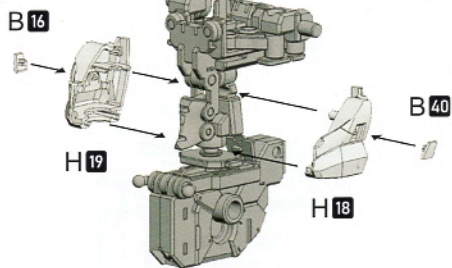

2 2

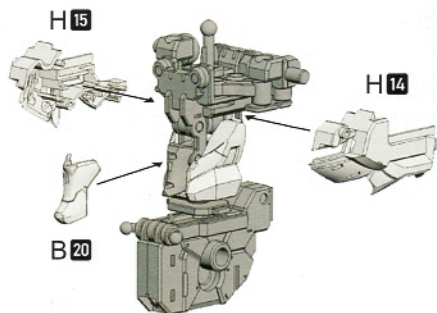
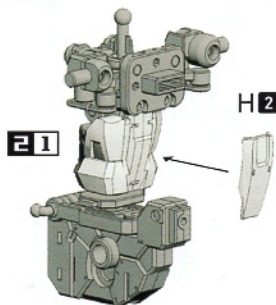

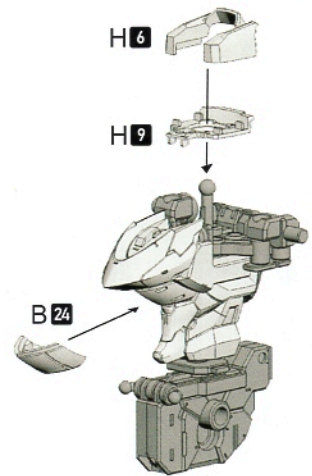
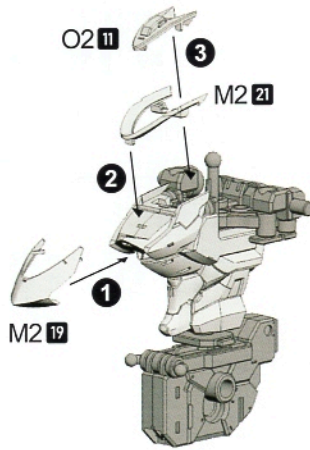
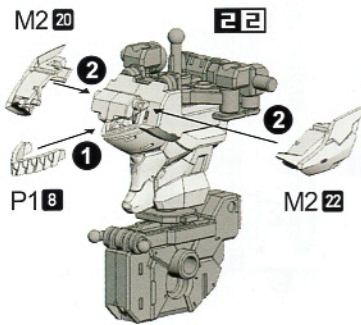
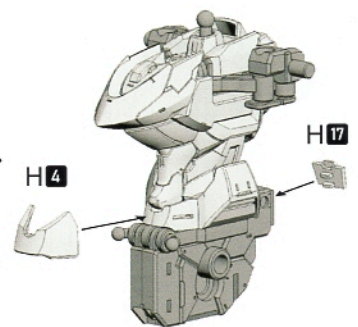
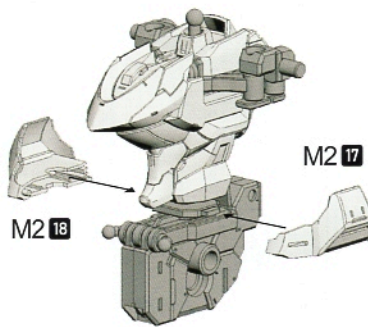
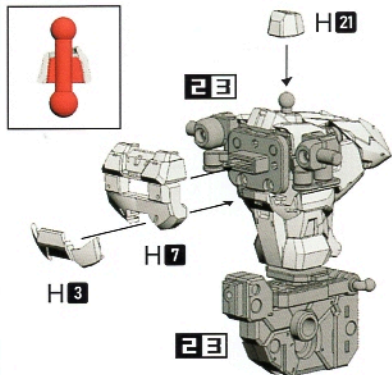
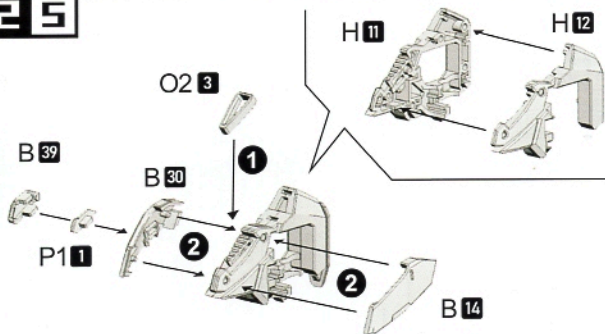
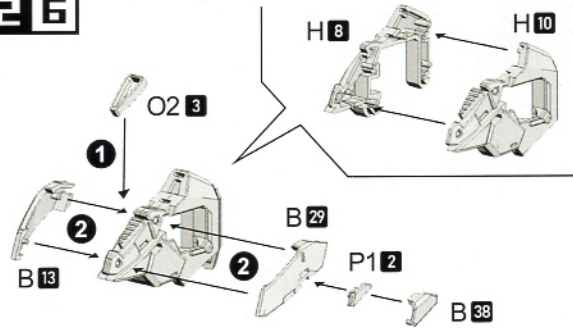
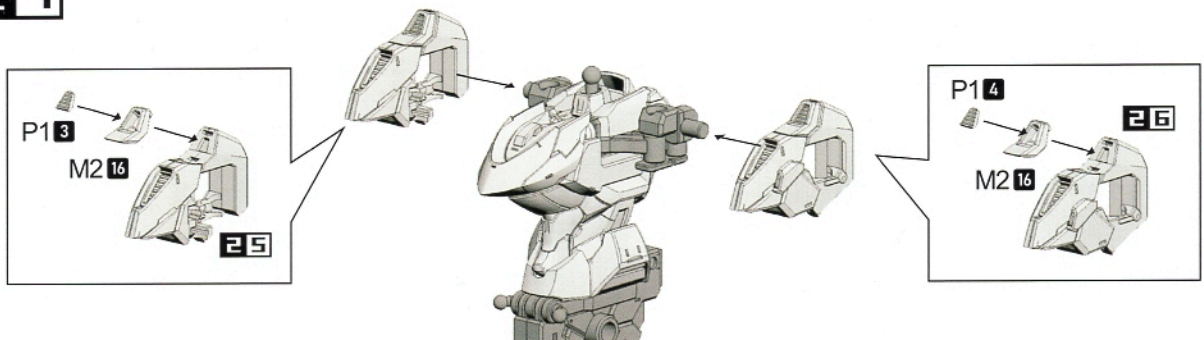
23**24****25****26****27**

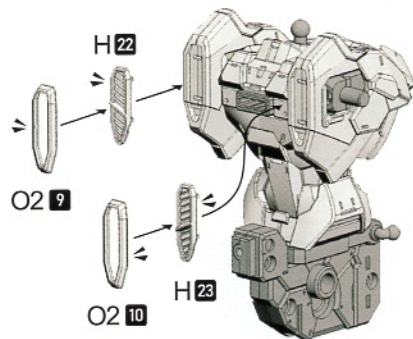
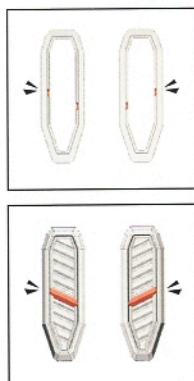
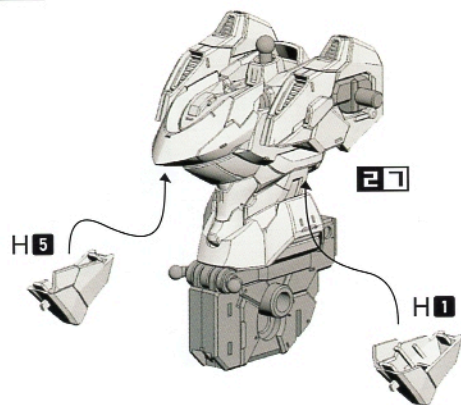
28

! 安装时注意方向
 • Pay attention to part orientation when assembling.

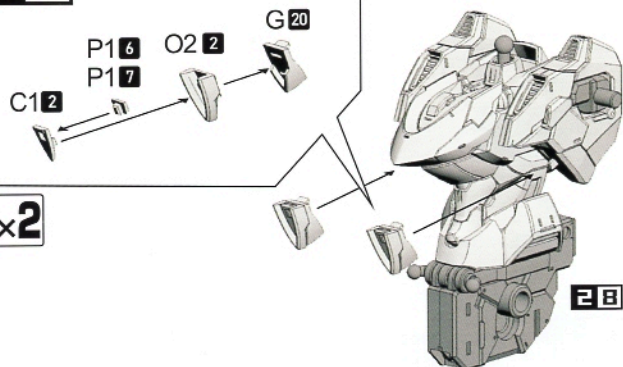
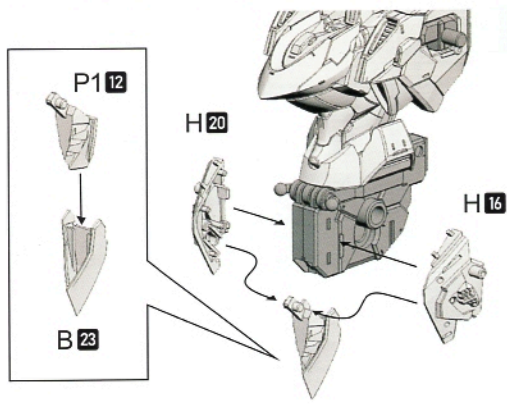
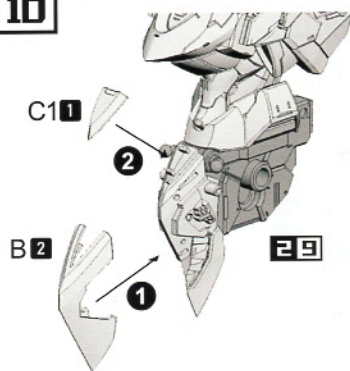
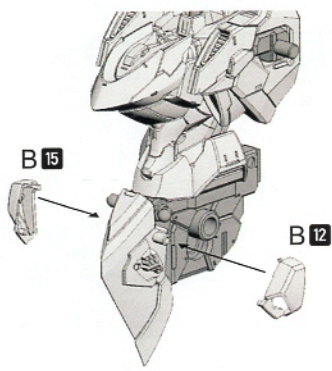
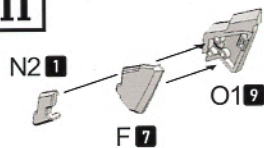
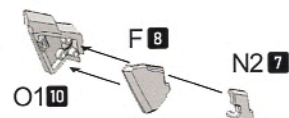
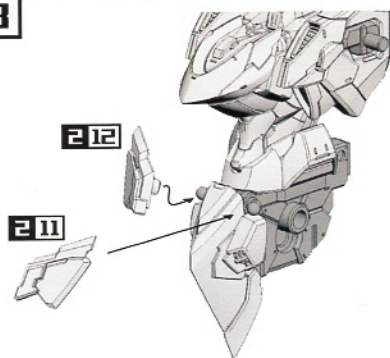
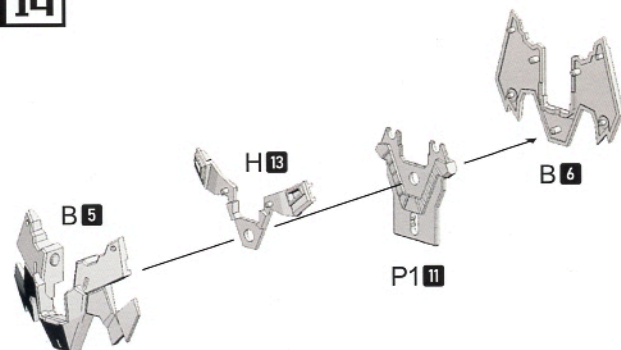
29**x2****28****210****29****211****212****213****214**

2 15

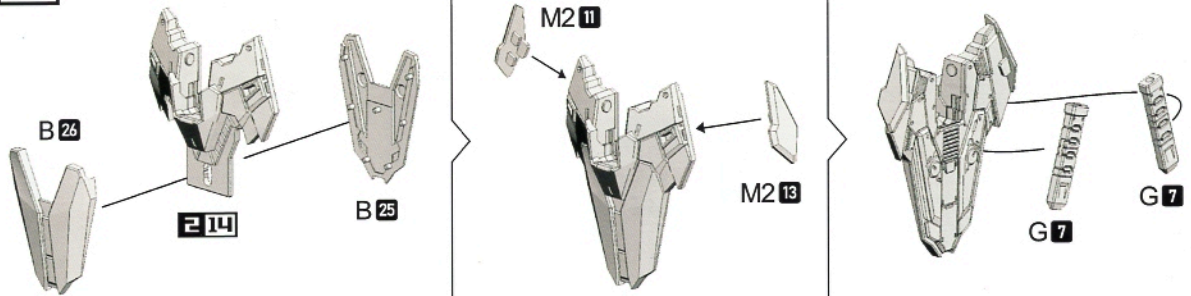

2 16

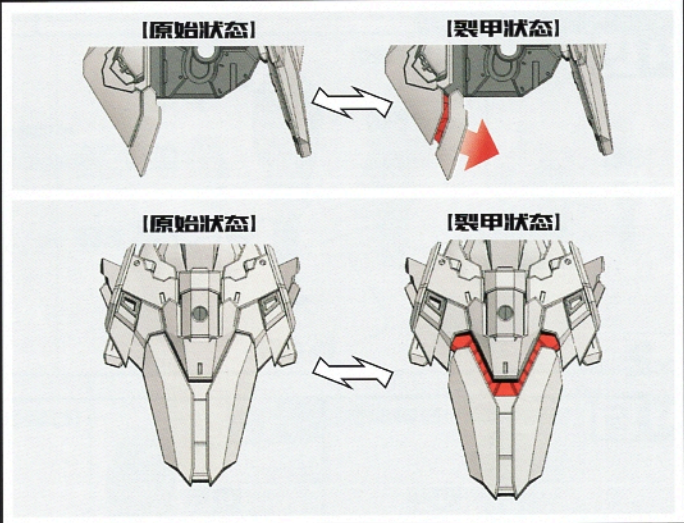
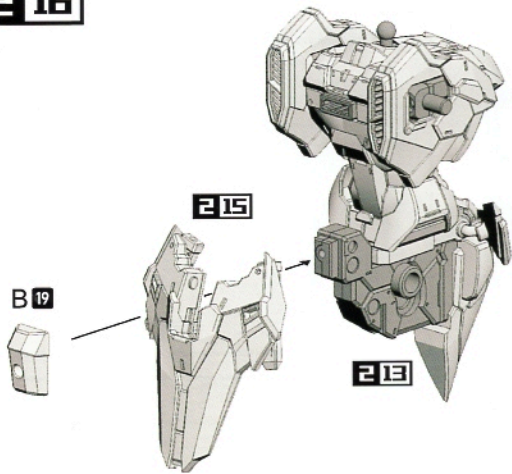

3 [肩膀组装] SHOULDER UNIT

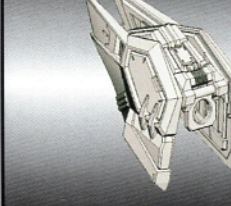

3 1

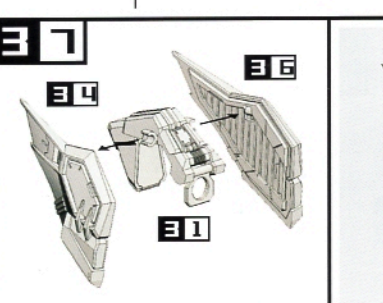
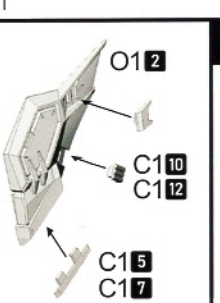
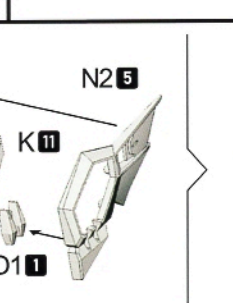
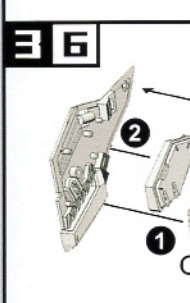
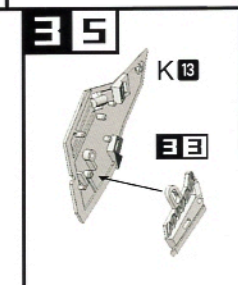
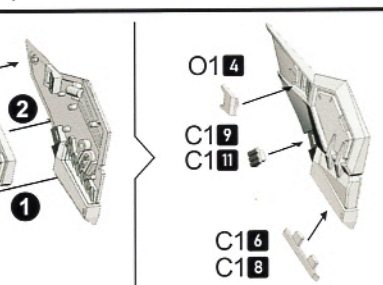
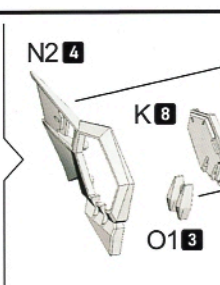
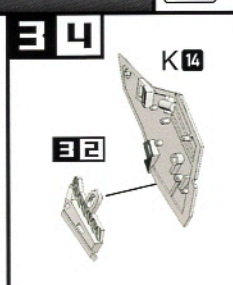
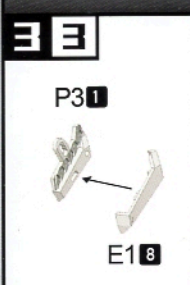
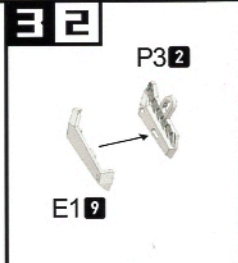
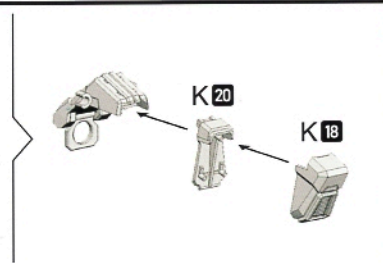
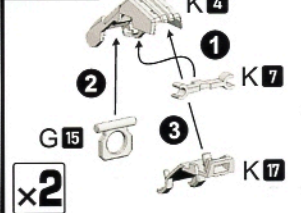

4 [手臂组装]

ARM UNIT



41

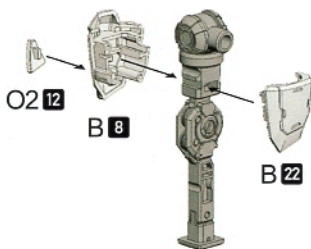

42

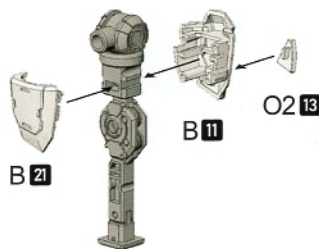

43

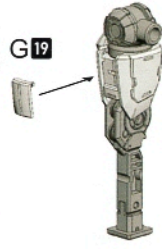

44

[左臂组装]

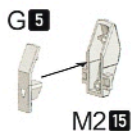

x2

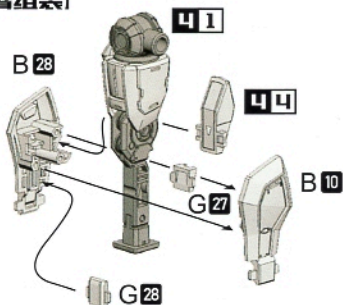

[右臂组装]

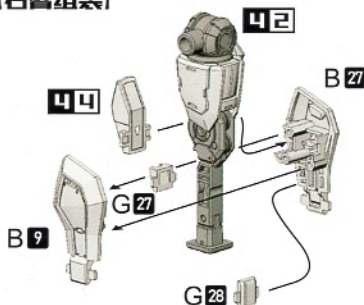
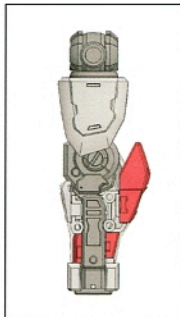

45

[左臂组装]

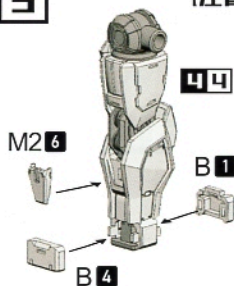

46

[右臂组装]

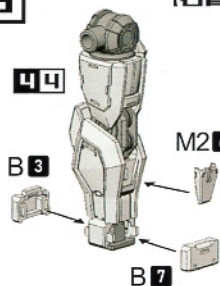

47

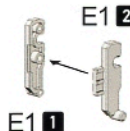

x2



47

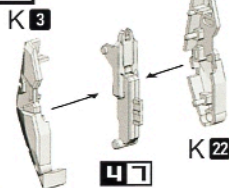

x2

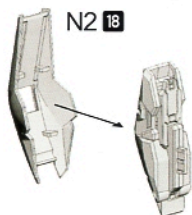

[左臂组装]

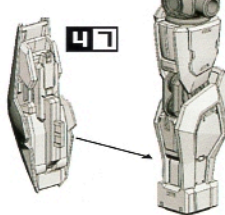

[右臂组装]

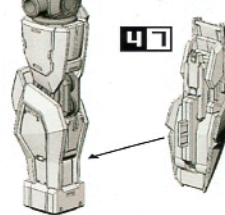

48

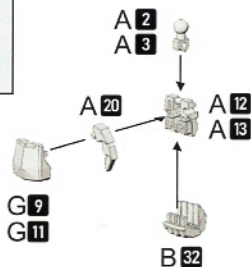
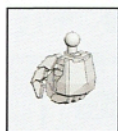
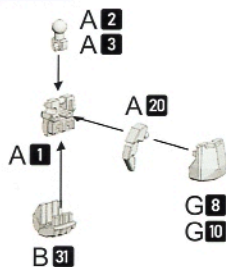

49

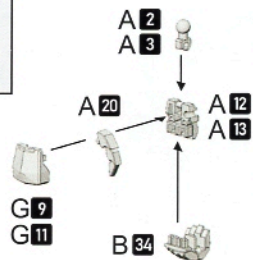
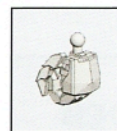
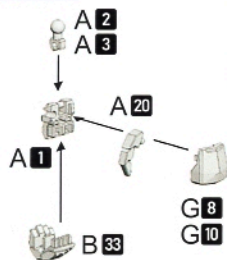

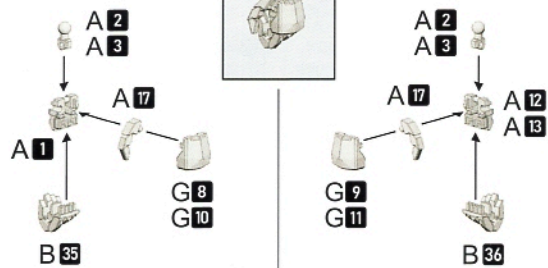
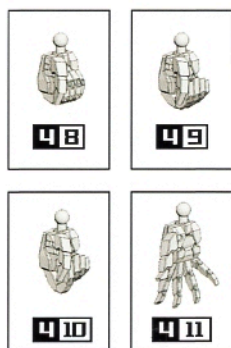
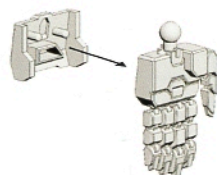
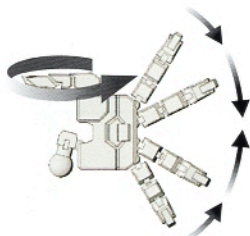
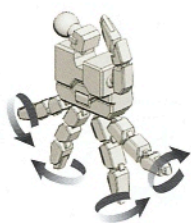
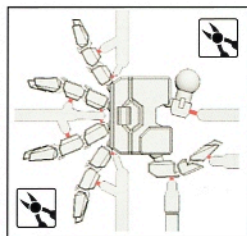
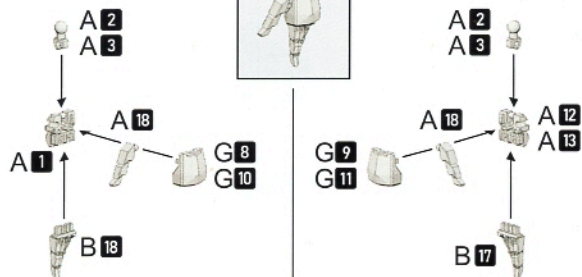
4 10**4 11**

[原始状态]

[裂甲状态]

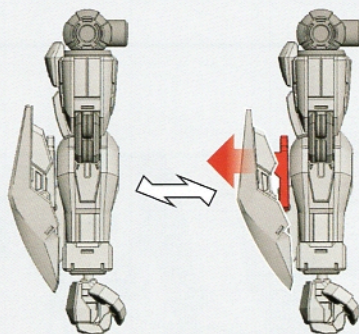
**5 [腿部组装]**

LEG UNIT

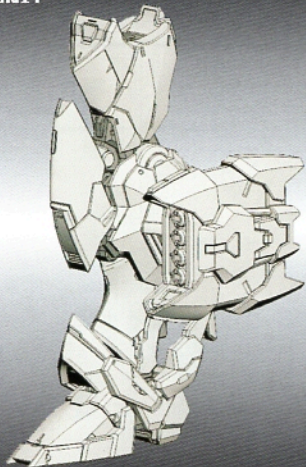
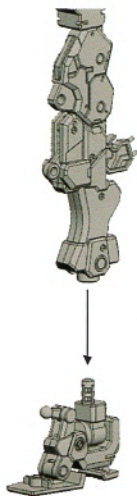
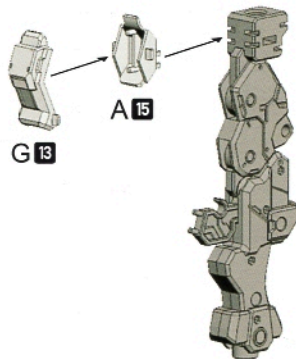
**5 1****06**

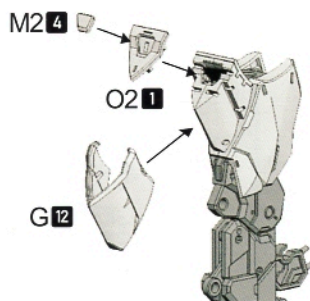
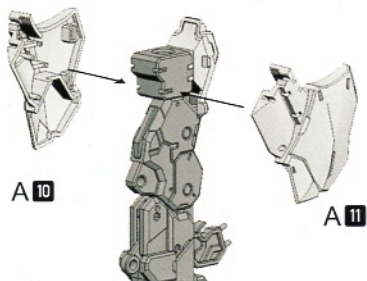
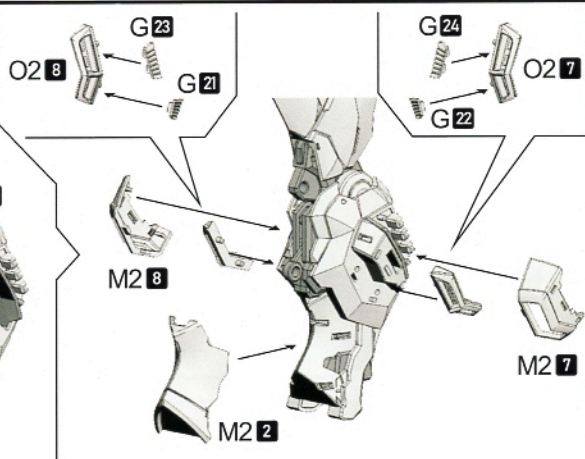
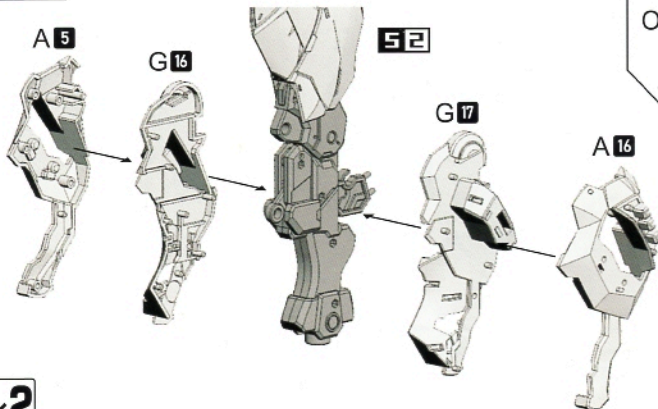
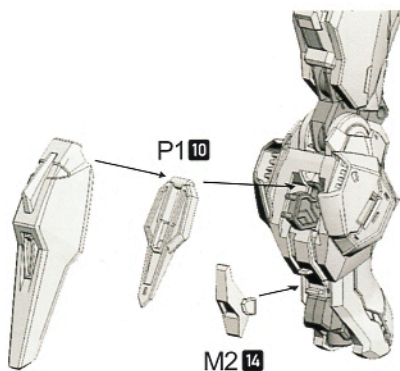
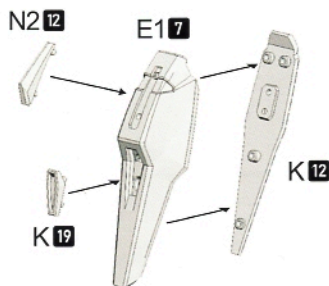
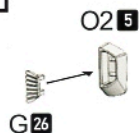
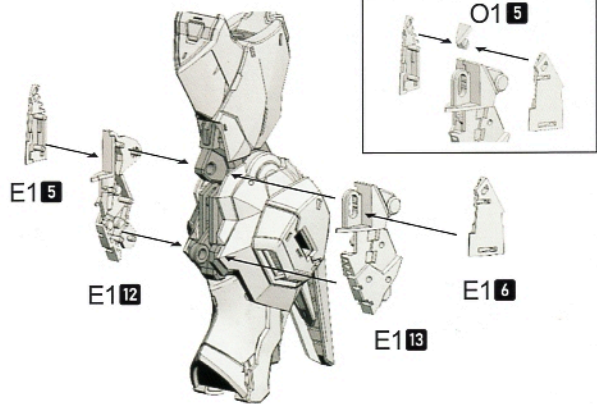
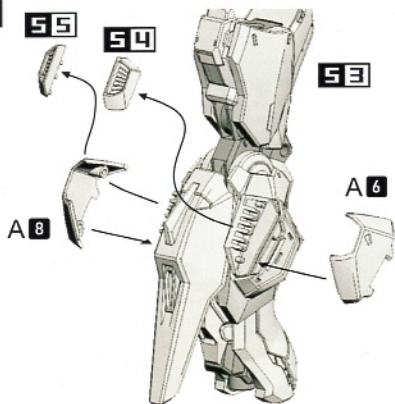
52**x2****53****x2****53****x2****54****x2****55****x2****56****x2**

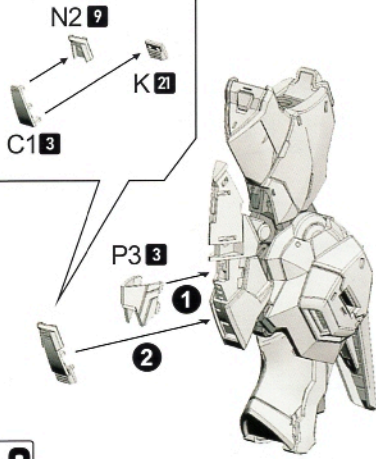
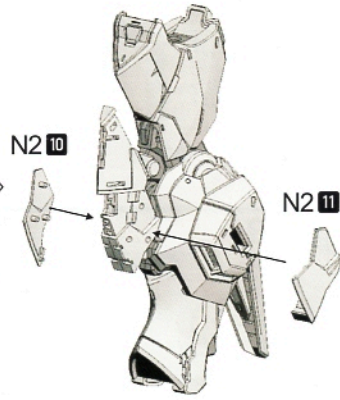
5 6**x2**

! • 安装时注意方向
• Pay attention to part orientation when assembling.

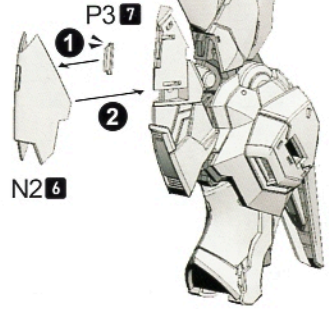
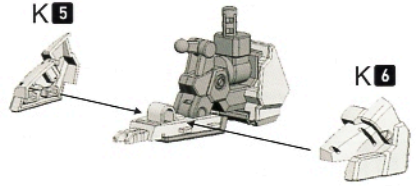
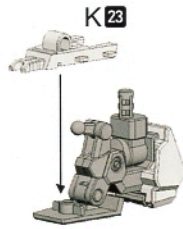
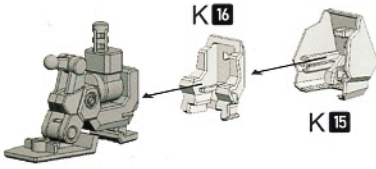
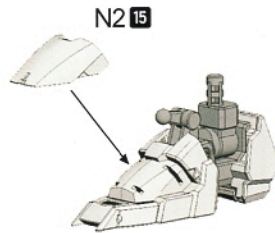
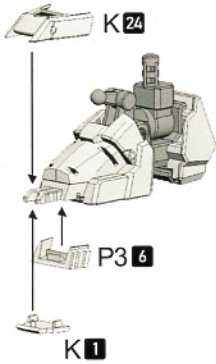
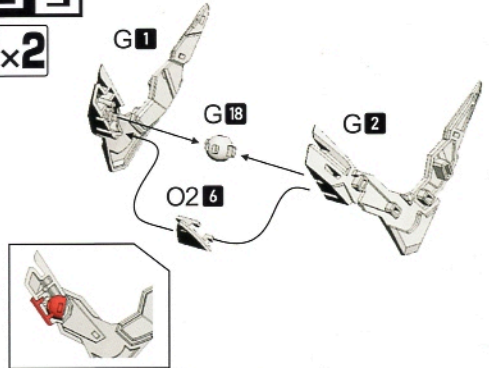
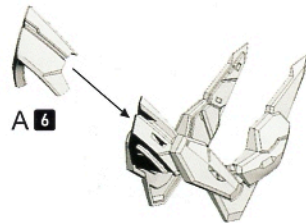
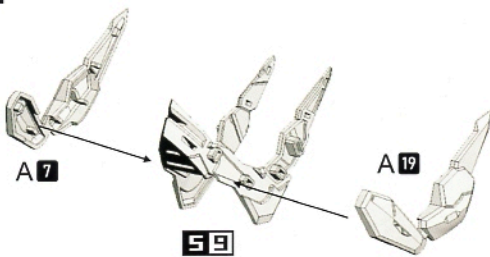
**5 7****x2****5 8****x2****5 9****x2****5 10****x2**

5 11

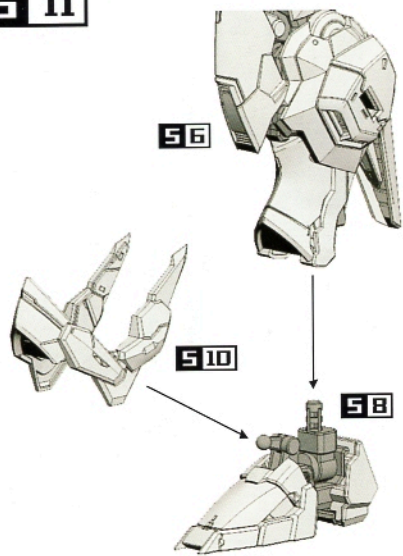

5 12

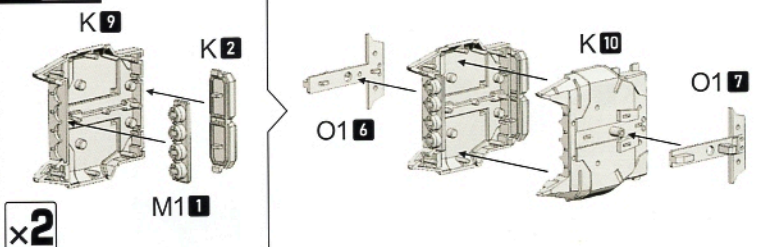

5 13

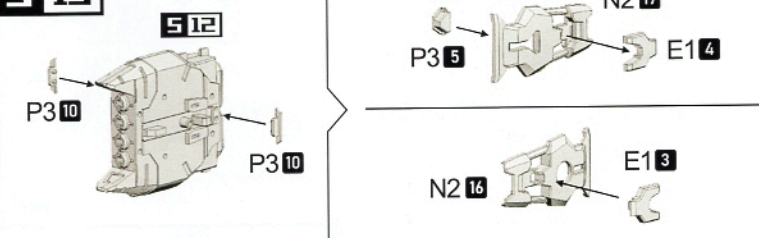

5 13

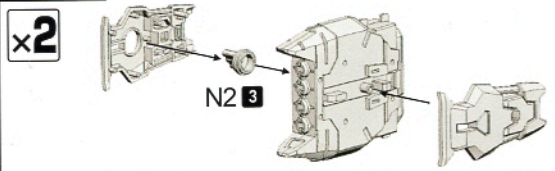

5 14

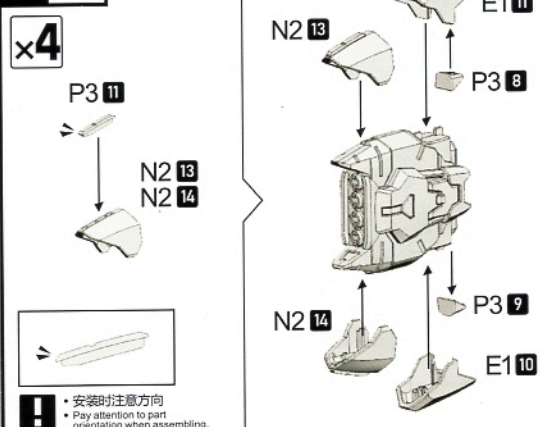

! 安装时注意方向
 • Pay attention to part orientation when assembling.

5 15

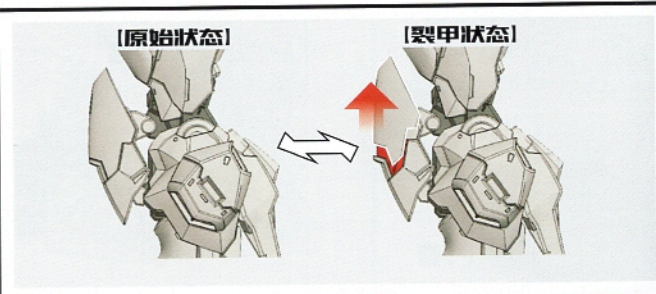
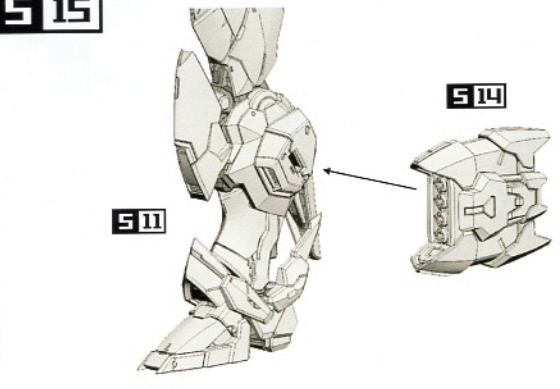

6 [腿部组装] BACKPACK UNIT

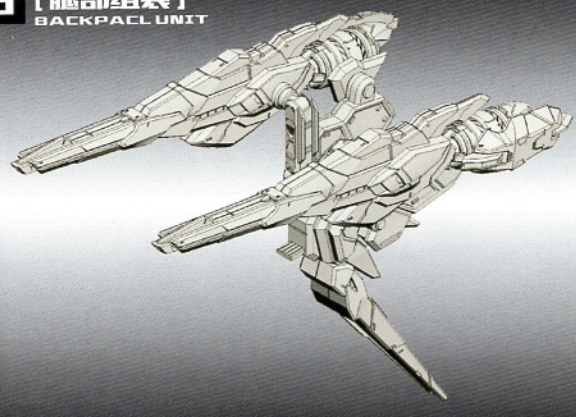

6 1

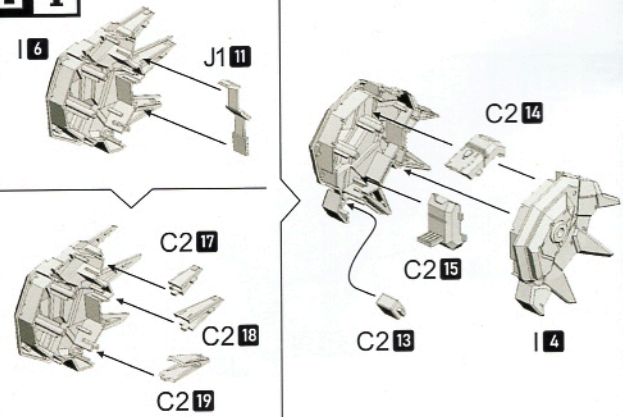

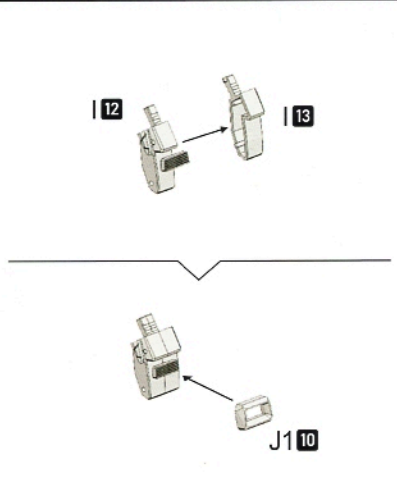
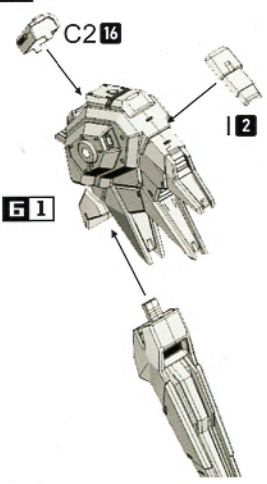
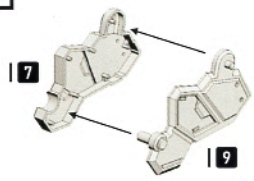
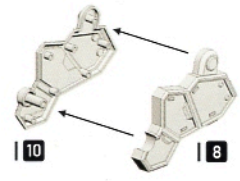
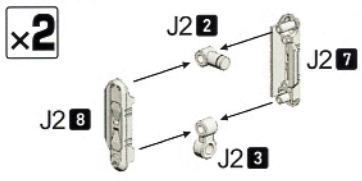
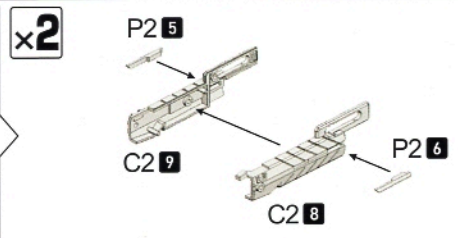
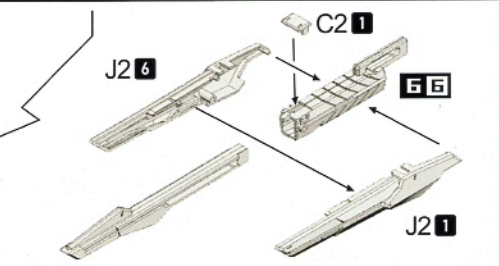
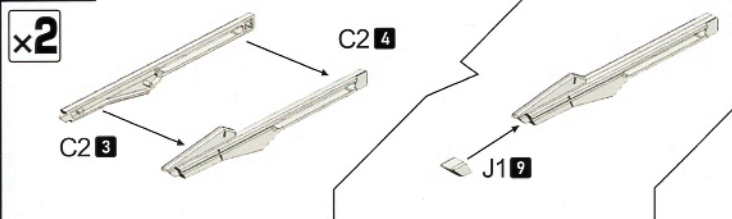
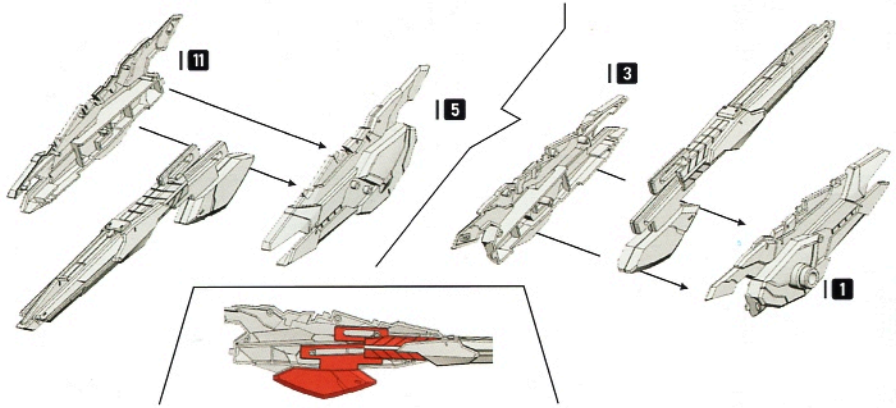
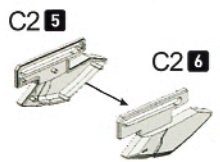
62**63****64****65****66****65****67****68**

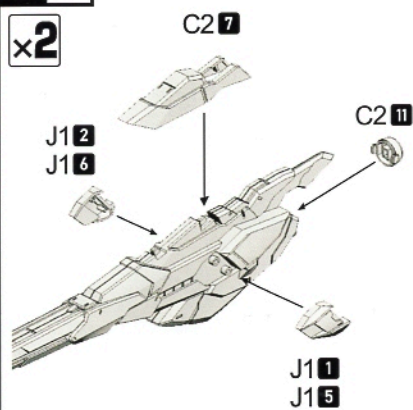
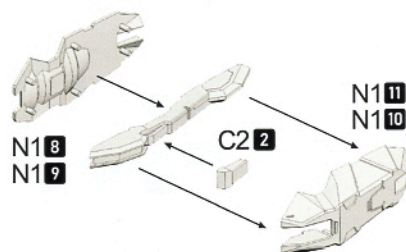
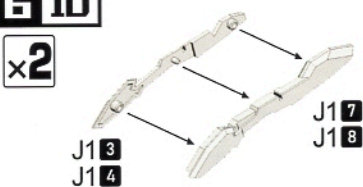
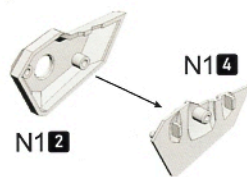
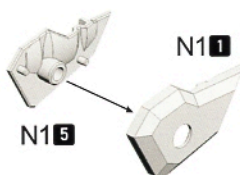
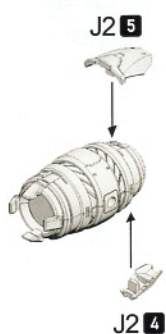
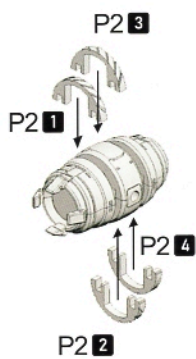
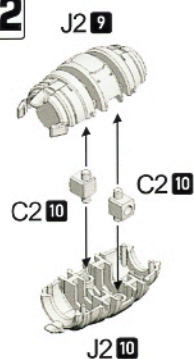
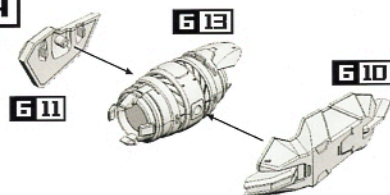
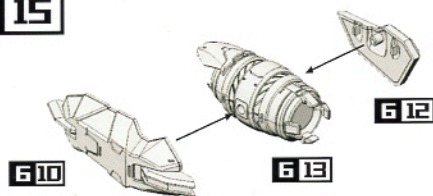
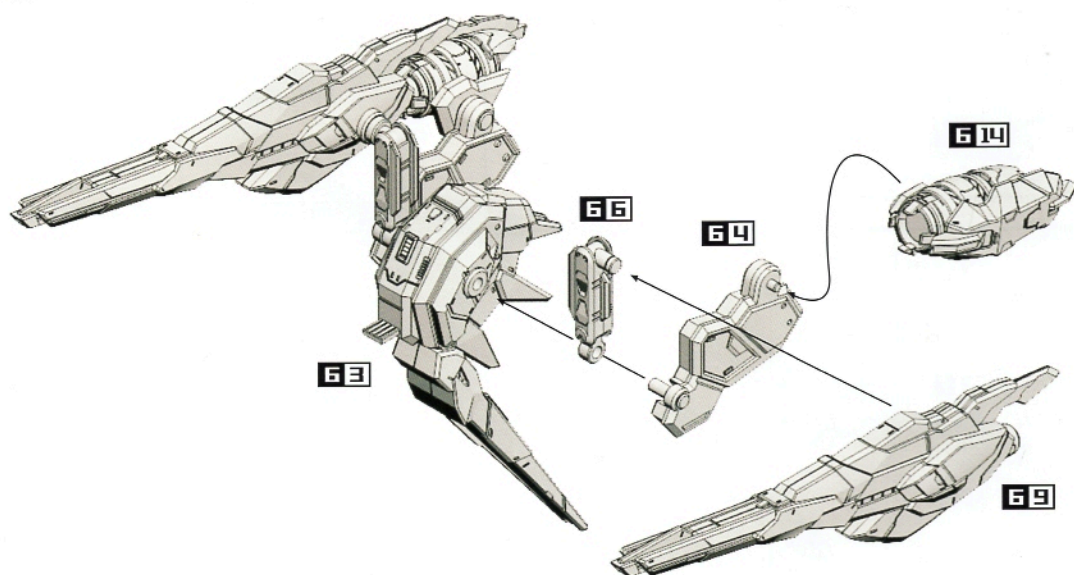
6 9**x2****6 10****x2****6 11****6 12****6 13****x2****6 14****6 15****6 15**

【原始状态】

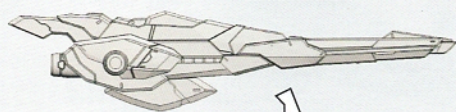

【裂甲状态】

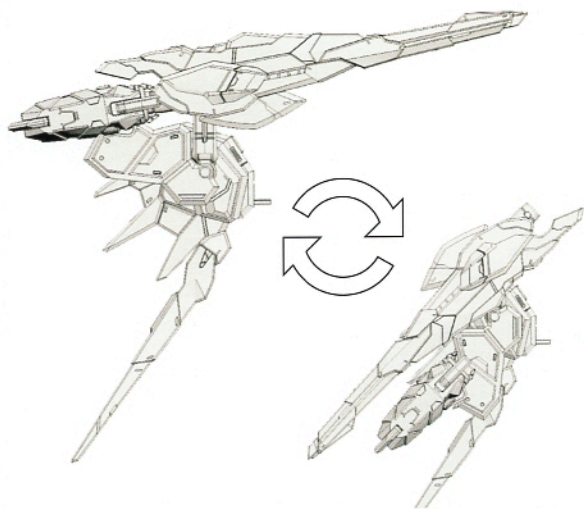
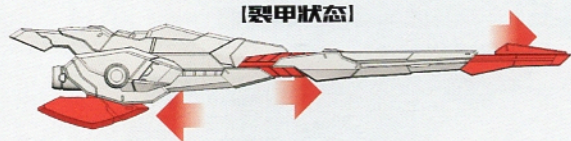

7 【武器组装】
WEAPON UNIT

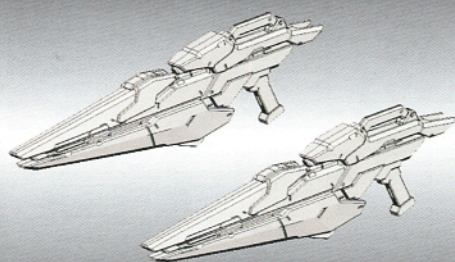

7 1

x2

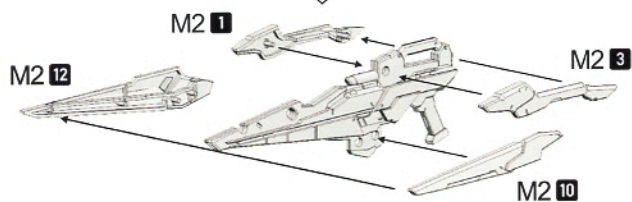
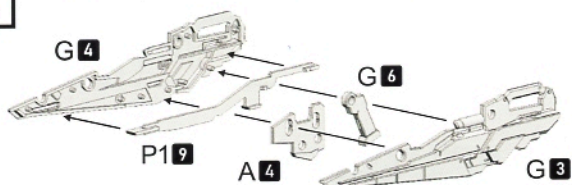

7 2

x2

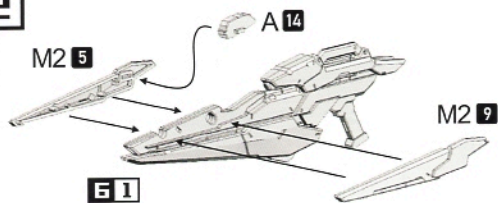

7 4

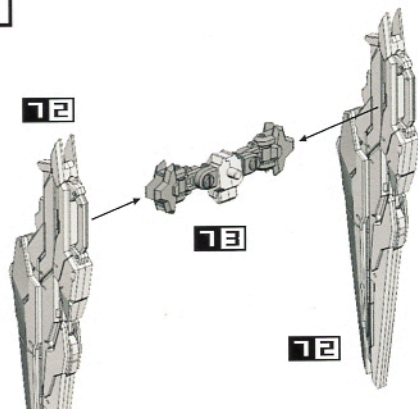

7 3

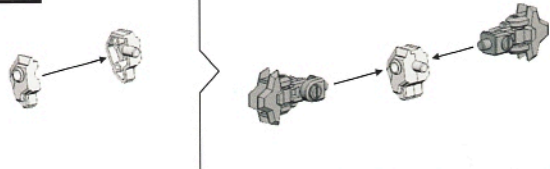

【原始状态】

【裂甲状态】

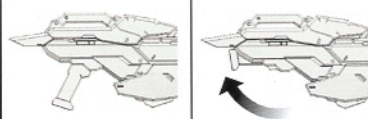

8 [武器组装]
WEAPON UNIT

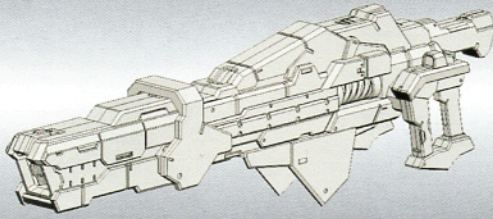

81

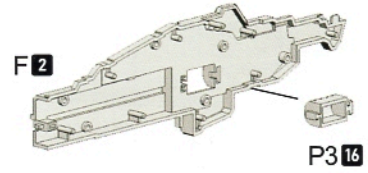

82

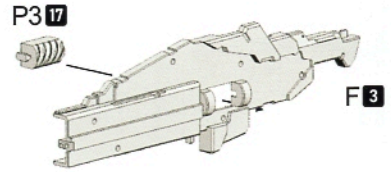

83

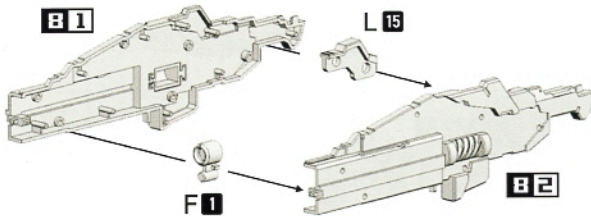

84

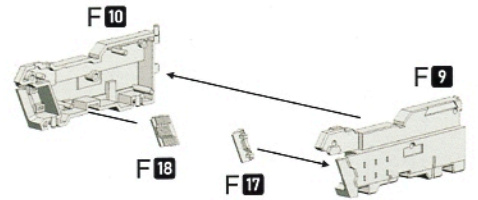

85

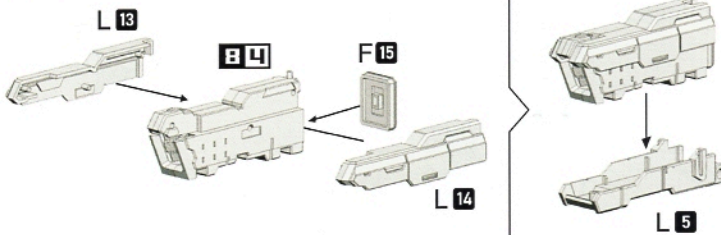

86

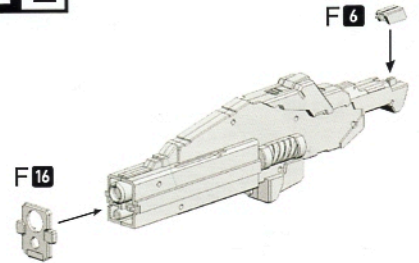

87

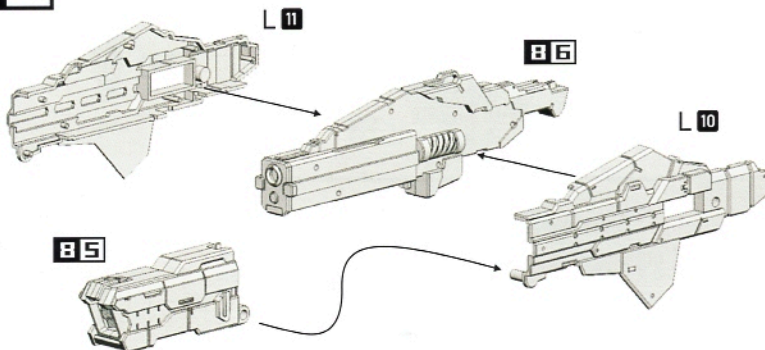

88

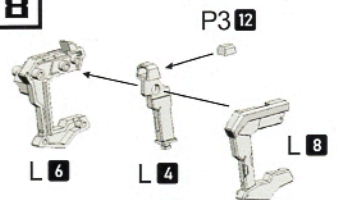

89

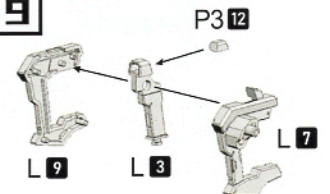

8 10

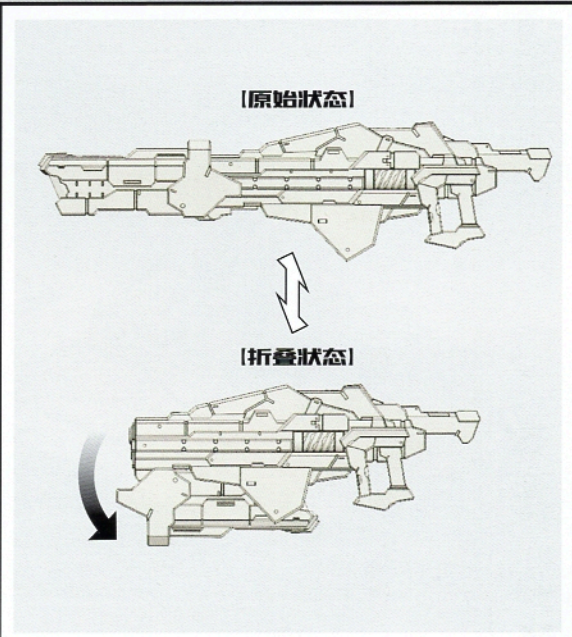
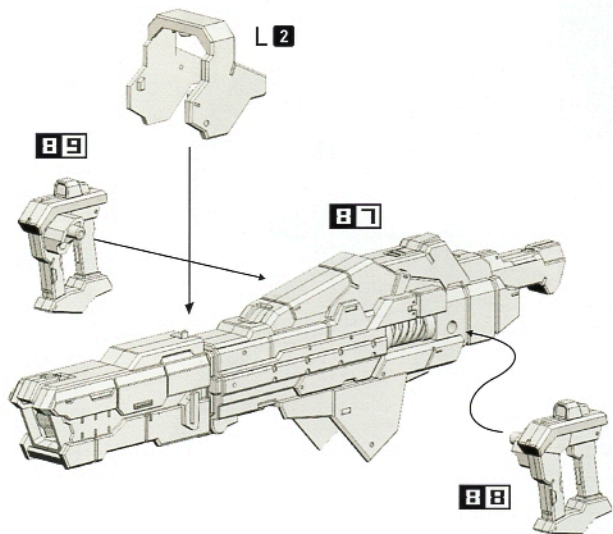

8 11

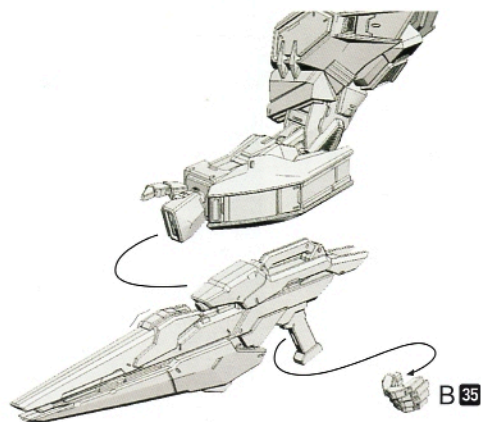
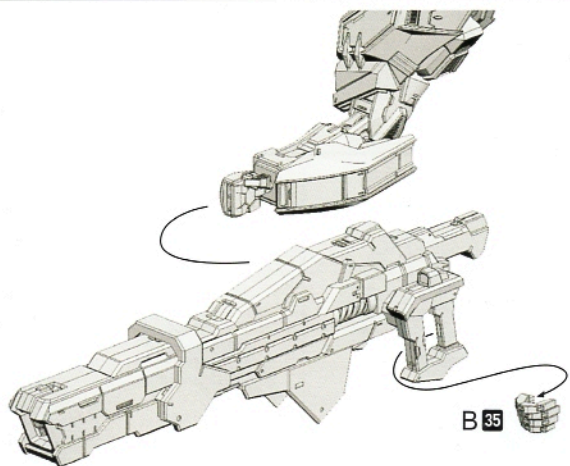
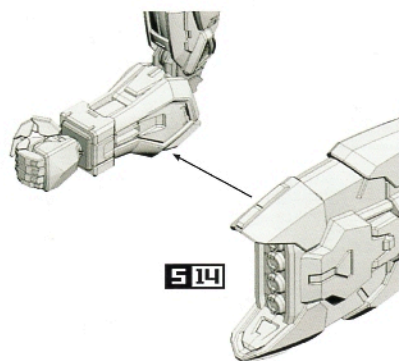
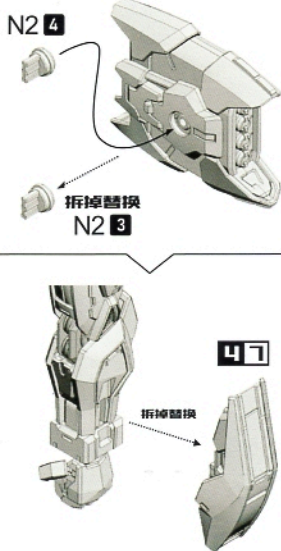
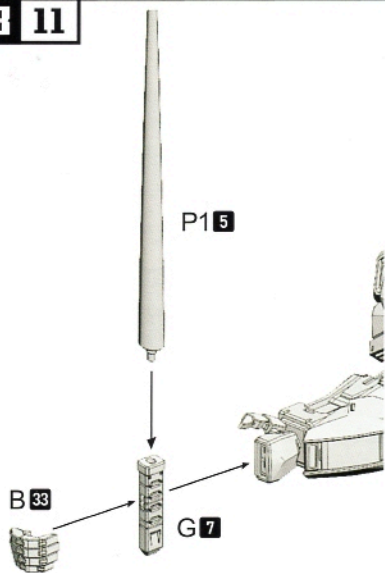

9 [支架组装]
STAND UNIT

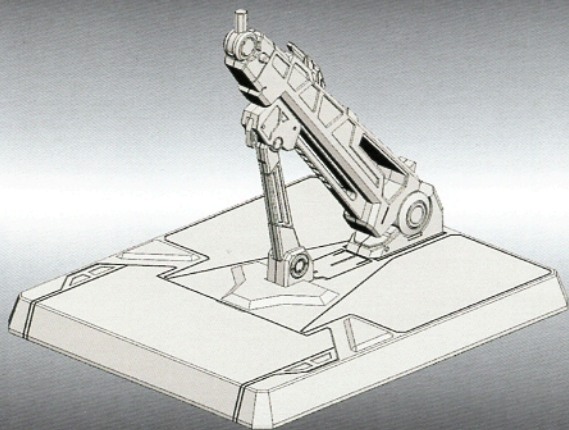

91

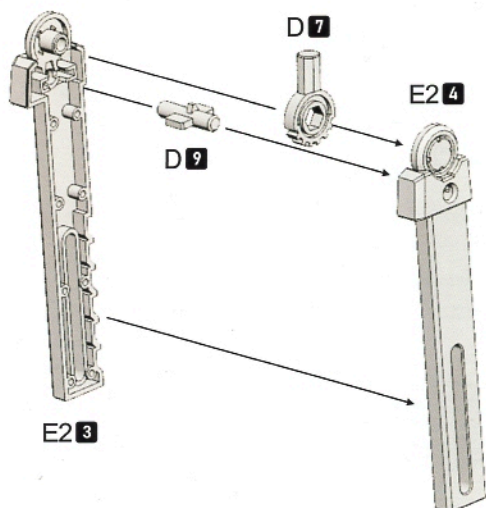

92

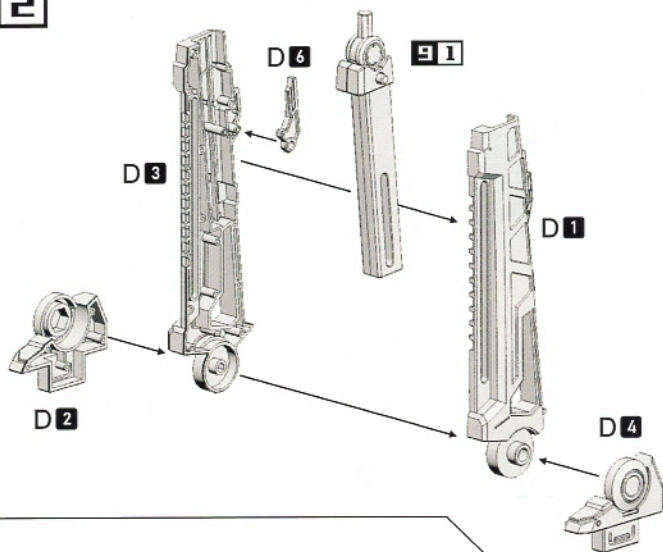

93

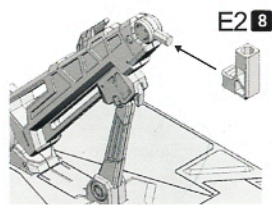
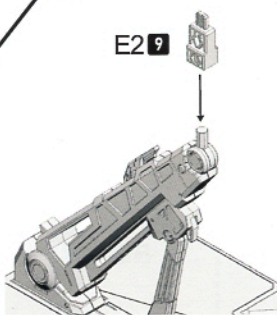
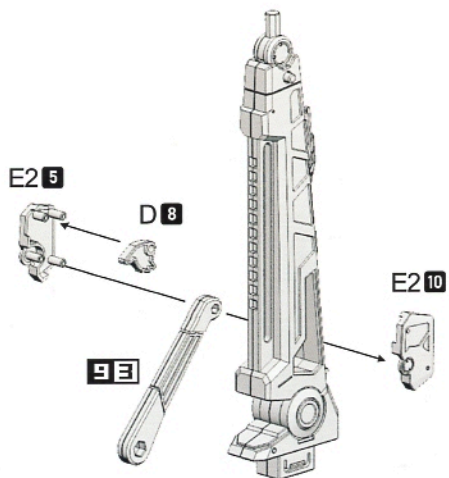
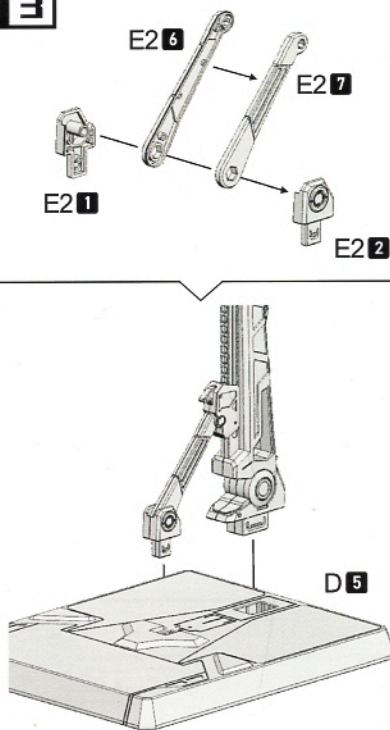

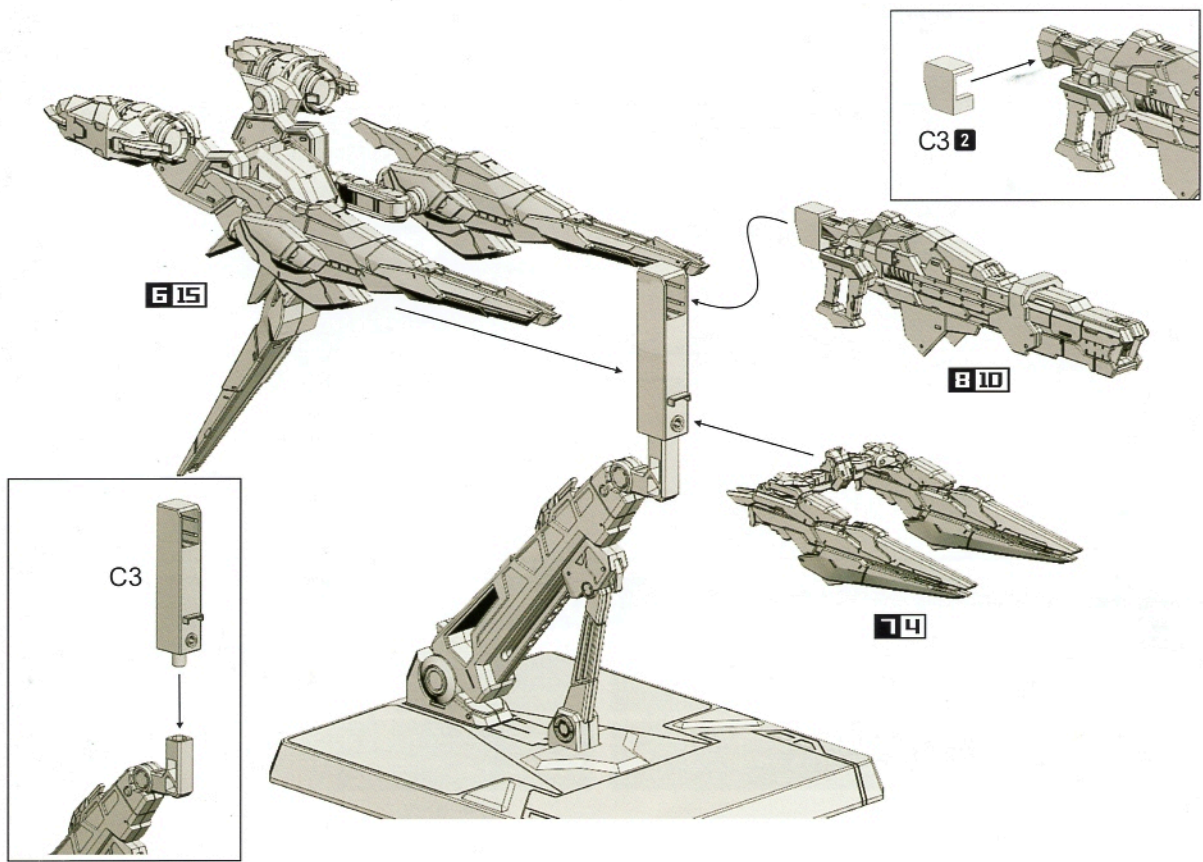

[收纳状态]

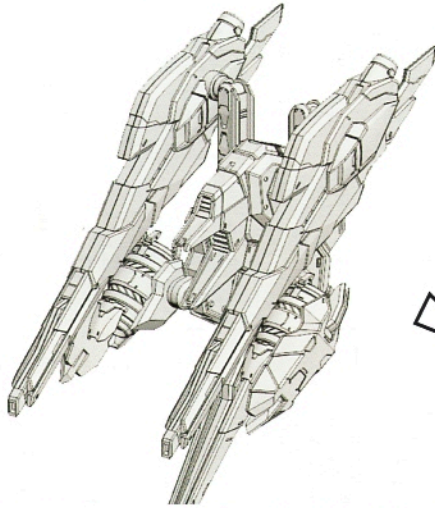

[战斗状态]

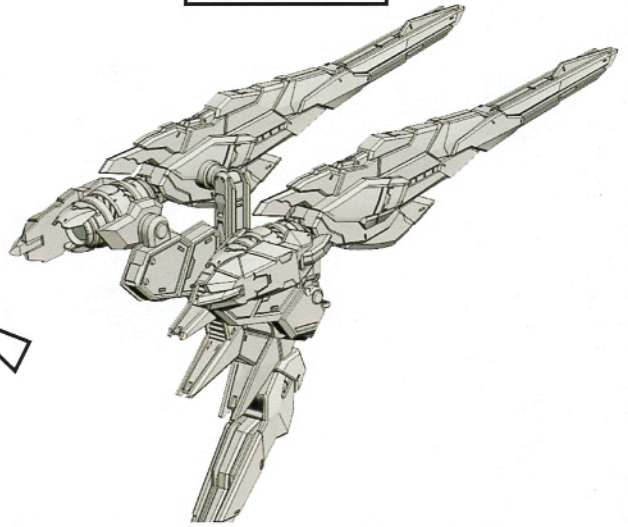

水贴贴法 WATER STICKER METHOD

用剪刀或笔刀连带底纸剪下水贴。
Use scissors or a pen knife and the backing paper to cut the drainer.

从底纸上轻轻掀开水贴，边调整位置边贴到合适位置。
Gently lift the water sticker from the bottom paper, and adjust the position while pasting to the appropriate position.

请把水贴贴在冷水或者温水表面放置10秒左右之后用镊子小心捞出。
Please put the water sticker on the surface of cold or warm water for about 10 seconds and carefully remove it with tweezers.

用棉签轻轻挤压已贴好的水贴并挤压出多余水分，等干透完成。
Gently squeeze the water sticker with a cotton swab and extrude excess water, and wait until dry.

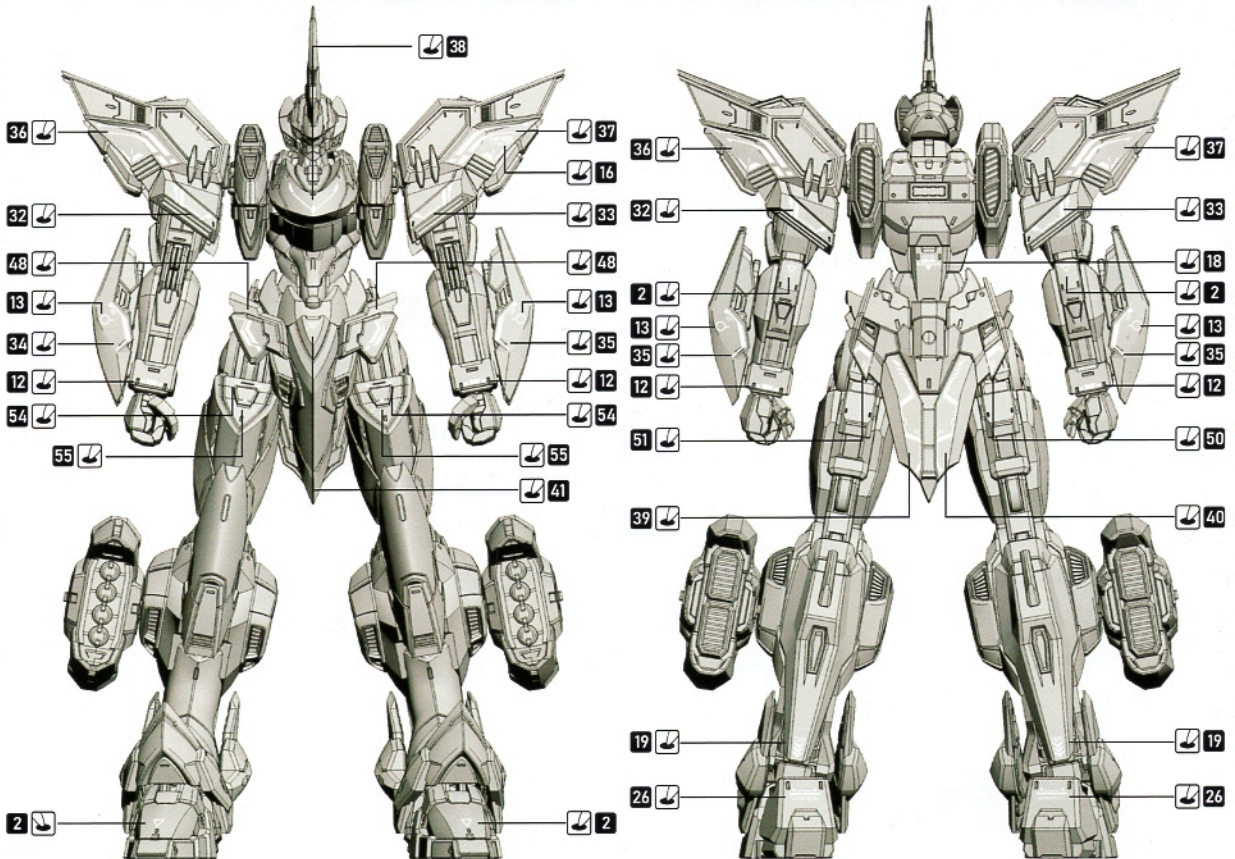

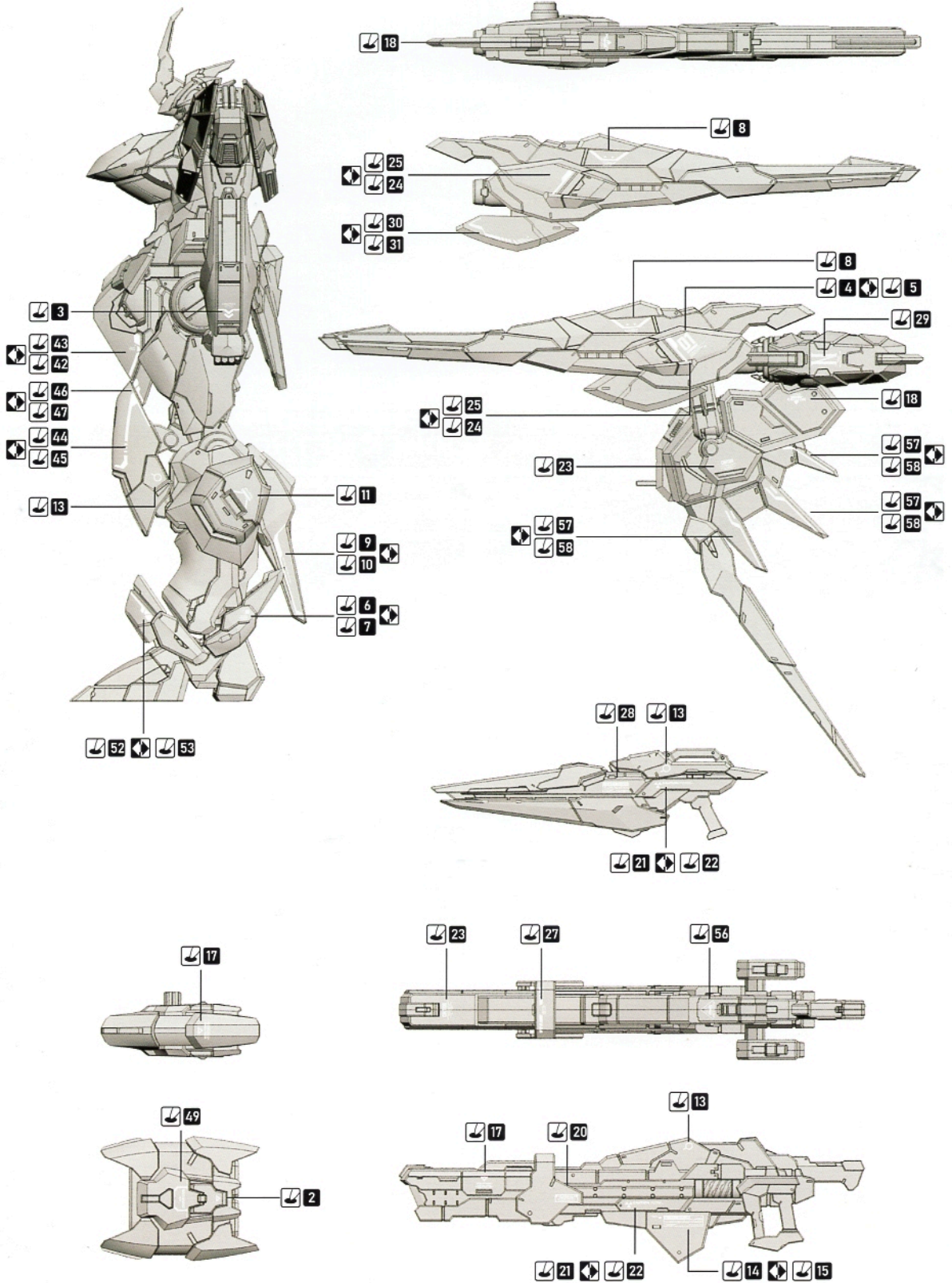



— 2023 MADE IN CHINA —